

CATALOGUE THERMOHYDRAULICS

STORAGE
HEATING
COOLING
SOLAR

BLADDER AUTOCLAVES FOR SANITARY WATER

MULTI-FUNCTIONAL TANKS

EXPANSION TANKS FOR HEATING

TANKS FOR SOLAR SYSTEMS

PLASTO - POLYETHYLENE STORAGE TANKS
FOR ABOVE GROUND

PLASTO - POLYETHYLENE STORAGE TANKS
FOR UNDERGROUND & WASTEWATER TREATMENT

GALVANIZED/GLASSLINED TANKS

HOT WATER TANKS

ASME TANKS



APPLICATIONS

GLASSLINED CYLINDER FOR HEAT PUMP

BSP

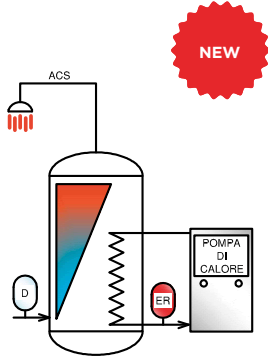

THERMAL FLYWHEEL WITH SINGLE HEAT EXCHANGER

PUFFER S1

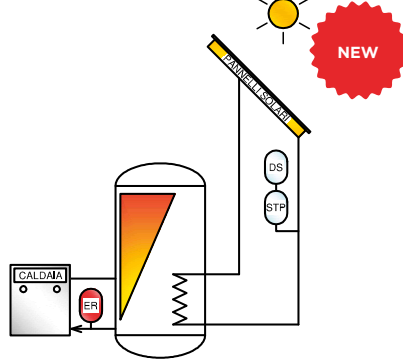

THERMAL FLYWHEEL WITH 2 HEAT EXCHANGERS

PUFFER S2

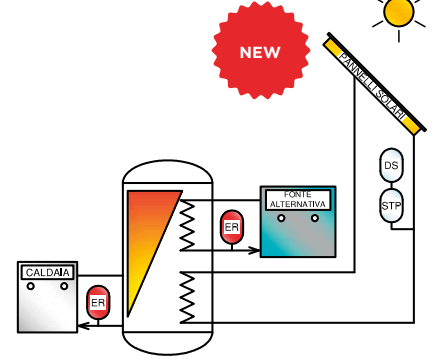

COMBI

CMS - STANDARD

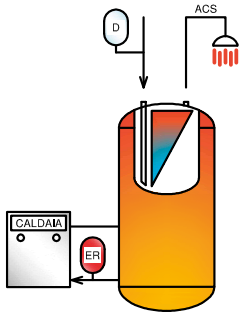

CMP - PLUS

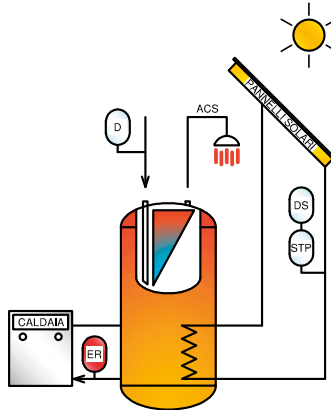

DHW CYLINDER WITH 2 HEAT EXCHANGERS

BST / BXT / BF-2 / BG

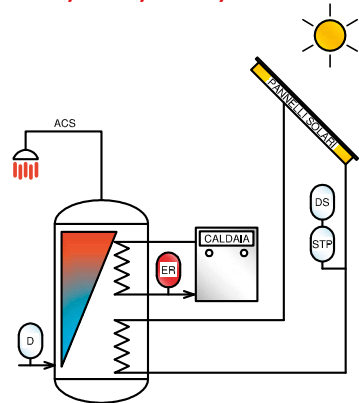

DHW CYLINDER WITH 1 HEAT EXCHANGER

BSH HORIZONTAL

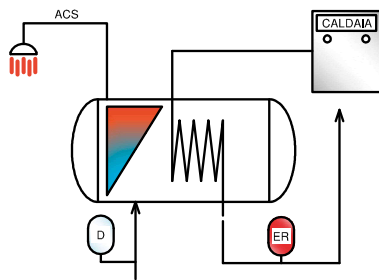

BSV / BSM / BXV / BF-1 / BG

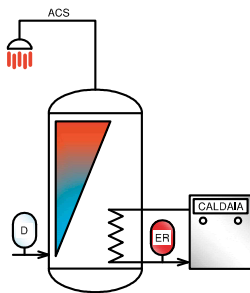

DHW CYLINDER WITH 3 HEAT EXCHANGERS

BF-3 / BG

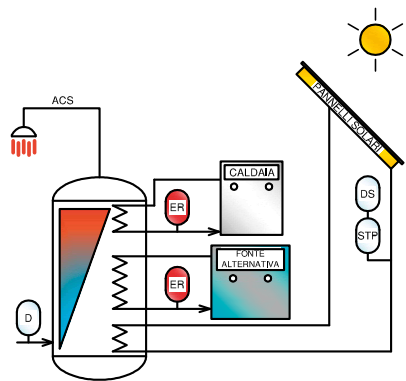

COMBI QUICK

CQS - STANDARD

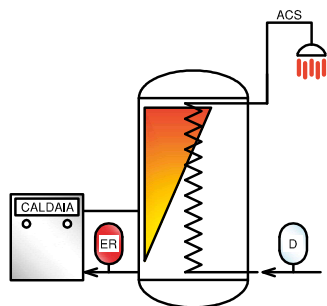

CQP - PLUS

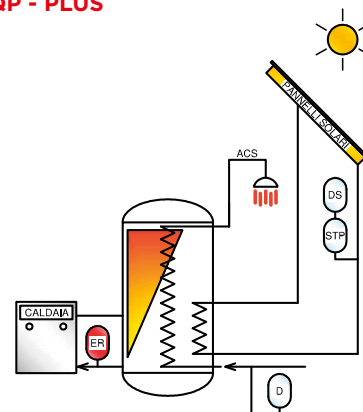

CQT - TWIN

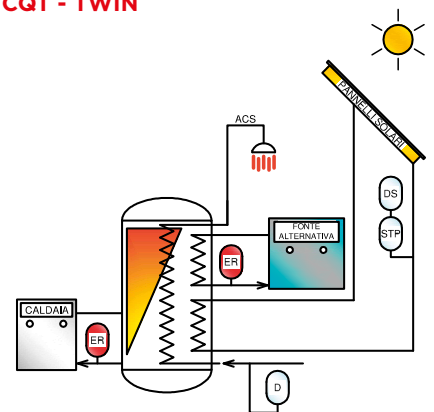



THERMOHYDRAULICS



13.	BLADDER AUTOCLAVES FOR SANITARY WATER
29.	MULTI-FUNCTIONAL TANKS (HEATING / SANITARY WATER)
43.	EXPANSION TANKS FOR HEATING
59.	TANKS FOR SOLAR SYSTEMS
67.	GALVANIZED/GLASSLINED TANKS
81.	HOT WATER TANKS
215.	ASME TANKS
227.	ACCESSORIES AND SPARE PARTS

History

ESTABLISHED IN 1965 IN VIGODARZERE NEAR PADUA, ELBI HAS ALWAYS DISTINGUISHED ITSELF FOR ITS LARGE VARIETY OF PRODUCTS AND ITS INTERNATIONAL VOCATION. THE COMPANY HAS BEEN OPERATING FOR ABOUT 50 YEARS IN THE FIELD OF THERMO-HYDRAULICS, GRADUALLY ACHIEVING A SOLID REPUTATION AND STANDING IN THE MAJOR WORLD MARKETS.



Originally established as a producer of hot water cylinders and central-heating boilers, after about a decade of activity in this field the company dedicated its efforts to the production of tanks for the thermo hydraulics industry. In the mid 70's Elbi began producing surge tanks and BLADDER expansion tanks, becoming one of the major European manufacturers in the field of Thermo hydraulics. In 1981, having overgrown the capacity of the Vigodarzere facility, the company moved to its present headquarters in Limena, thus expanding its production capacity.

In 1989 the company branched off into a new line of products, processing plastic materials and manufacturing rotational-moulded polyethylene tanks.

In 1990 Elbi of America, Inc. was founded in Houston, Texas. Initially the new company concentrated on simple marketing/sales activities, learning about the culture and mentality of the vast and complex American continent.

In 1994 the Green System sales division was established to manufacture and market pots for plants and flowers made of rotational-moulded polyethylene. Thus the company entered the new market of gardening, which enabled it to expand its know-how both in the technological and marketing fields.

Firmly established in the American market, in 1996 Elbi of America became the official manufacturing headquarters for the fixed-bladder tanks, thus bringing production closer to the target market.

The company's third sales division, Environment, was established in 1997 to design and produce containers and bells for selective collection of waste, and to market a wide range of accessories for urban hygiene and decor.

In 2001 a new production facility was opened in Modugno (BA), mainly dedicated to the manufacture of products made of rotational-moulded polyethylene. Elbi's activity in the Environmental Services started in 2006 and is mainly focused as preventive maintenance which is performed by special purpose structures (local units) where only qualified personnel are employed and adequate equipment used. In 2006 Elbi also started the Playground Division becoming the Italian distributor of a range of playground equipment for parks and schools offering a range for children from 18 months through 16 years of age. In 2008 Elbi also entered the Well-being market, becoming the Italian distributor of a range composed of an innovative "well-being track" formed by several sporting gear that facilitates open-air physical exercise in adults and elderly people.

In 2008 a new business unit consisting of design products for the furniture market took shape. The need to manage a new brand dedicated to such target brought about a restyling of the traditional Green System Division, thus giving life to the TWENTY-FIRST Division, distinguished in GARDENART for the traditional collection of garden pots, and LIVINGART for the collection of furnishing accessories for the living market. Today, Elbi concentrates its production activities in the business divisions (Thermo-hydraulics - Environment - 21st Garden Art - 21st Living Art) whose products are manufactured in the production plants in Limena and Modugno, yet again confirming the company's industrial reality.



TECHNOLOGY

Active since 1981, the Limena plant is sub-divided into various production areas, each specialising in specific processes.

MECHANICS

The transformation of metals currently makes up around 70% of production activities, and uses technologies for: moulding, cutting and sheet bending; welding of carbon steel and stainless steel; epoxy powder painting and assembly.

The entire production process is implemented with wide use of industrial automation and robots to handle and move the manufactured parts.

Production is organised and monitored using an integrated company information system, starting with the analysis and planning of production up to sale of the end product. This information structure is supported by our Data Processing Service, which meets the particular information requirements by implementing and developing ad hoc part of the software.























PLASTIC MATERIAL























In the early 90's Elbi wanted to undertake a new production path by processing plastic materials, obtaining considerable results in terms of technological innovation. Elbi has been a member of ARM (Association of Rotational Molders) since 1996, an international category association that represents its members composed of rotational-moulding companies and professionals in the industry from 66 nations. The rotational moulding division has furnaces for polyethylene moulding,

7 in the main plant and 2 in the Modugno (Bari) plant. The biggest furnace can mould products with a capacity of up to 15.000 litres, among the biggest in Europe. Through rotational moulding technology, Elbi can manufacture a vast range of products in non-toxic and recyclable polyethylene: other than the first collection tanks (water, alimentary liquids, chemicals and other types of fluids). Elbi designs and manufactures design furnishing accessories, vases for plants and flowers, dog and cat houses, bins for differentiated waste collection, bins for urban waste collection and containers for composting of organic waste, thereby contributing to reduced environmental pollution.



pictograms

	= Thermometer
	= Thermostat
	= Anode with tester
	= Magnesium anode
	= Anode with simpletest
	= Polyurethane insulation
P_{MAX}	= Max Working pressure (bar)
P_{SCA}	= Heat Exchanger max pressure (bar)
P_{MAX VS}	= Max Working pressure (bar)
P_{MAX VE}	= Max Working pressure (bar)
P_{PRE}	= Pre-charge pressure (bar)
	= Working Temperature
	= Heat Exchanger Max Working Temperature
	= Hot water cylinder Max Working Temperature
	= Heat Accumulator Max Working Temperature
	= Sanitary DHW heat exchanger - Max Working Temperature
CE	= CE Approval (2014/68/UE)
	= For drinking water
	= Not for drinking water
	= For heating systems
	= For air conditioning systems
	= For booster pumping systems
	= Top-Pro® internal protection
	= Glasslining anti-corrosion internal treatment
	= Water hammer arrestor
	= Suitable for chemicals
	= For sanitary hot water
	= For chilled water

-  = for heating pumps
-  = handling by forklift
-  = Heat accumulator for instant sanitary hot water
-  = vehicles transit not suitable
-  = Packaging mm
-  = Capacity (liters)
-  = Model
-  = Weight (Kg)
-  = Height (mm)
-  = Side (mm)
-  = Width by length (mm)
-  = Diameter (mm)
-  = Galvanized
-  = Painted
-  = Stainless steel body
-  = Self-pressurized model
-  = For compressed air
-  = Hot water cylinder
-  = Hot water storage tank
-  = Stainless steel coil
-  = Stainless steel coil for use with steam
-  = Inspection hole Ø
-  = Code
-  = Heat exchanger
-  = For solar systems
-  = ASME U Approval
-  = ASME UM Approval



ENGLAND

RUSSIA

UKRAINE

CROATIA

U.S.A.

U.S.A.

Index

13. BLADDER AUTOCLAVES FOR SANITARY WATER

- 16. **AS/AC-CE:** REPLACEABLE BLADDER AUTOCLAVES FOR SANITARY WATER (2 - 25 LITRES)
- 18. **AF-CE:** REPLACEABLE BLADDER AUTOCLAVES FOR SANITARY WATER (35 - 500 LITRES)
- 22. **AFV-Z-CE:** GALVANIZED AUTOCLAVES WITH REPLACEABLE BLADDER, FOR SANITARY WATER (60 - 500 LITRES)
- 24. **HI-NOX-CE:** STAINLESS STEEL AUTOCLAVES WITH REPLACEABLE BLADDER, FOR SANITARY WATER (0,16 - 60 LITRES)
- 26. AUTOCLAVE EFFICIENCY
- 26. HOW TO SIZE A BLADDER AUTOCLAVE

29. MULTI-FUNCTIONAL TANKS (HEATING / SANITARY WATER)

- 32. **AC-2 / D-CE:** MULTI-FUNCTIONAL SANITARY TANKS WITH FIXED-BLADDER (2 - 500 LITRES)
- 34. **DE-CE:** MULTI-FUNCTIONAL SANITARY TANKS WITH REPLACEABLE BUTYL BLADDER (8 - 24 LITRES)
- 36. **DL-CE:** REPLACEABLE BLADDER MULTI-FUNCTIONAL TANKS (750 - 5.000 LITRES)
- 38. **MICRON:** WATER HAMMER ARRESTOR MINI TANK (160 ML)
- 40. **SANY:** REPLACEABLE BLADDER SANITARY TANKS, FOR SMALL SPACES (0.5 - 6 LITRES)

43. EXPANSION TANKS FOR HEATING

- 46. **AC-2 / ER-CE:** FIXED BLADDER EXPANSION TANKS FOR HEATING (2 - 24 LITRES)
- 48. **ERCE:** FIXED BLADDER EXPANSION TANKS FOR HEATING (35 - 500 LITRES)
- 50. **ERP:** FIXED-BLADDER FLAT EXPANSION TANKS FOR BURNERS (6 - 24 LITRES)
- 52. SIZING AN EXPANSION TANK (RACCOLTA "R", ED. 2009)
- 55. UNIVERSAL DIAGRAM FOR SELECTING AN EXPANSION TANK

59. TANKS FOR SOLAR SYSTEMS

- 62. **DS-CE:** EXPANSION TANKS FOR SOLAR SYSTEMS (8 - 300 LITRES)
- 63. HOW TO SELECT THE RIGHT EXPANSION TANK FOR SOLAR SYSTEMS
- 64. **STP:** ADDITIONAL TANKS FOR TEMPERATURE REDUCING (5 - 50 LITRES)

67. GALVANIZED/GLASSLINED TANKS

- 70. **AIR:** GALVANIZED TANKS FOR COMPRESSED AIR, CE CERTIFIED (750 - 10.000 LITRES)
- 72. **ACM - ACZ:** GALVANIZED TANKS FOR COLD WATER, CE CERTIFIED (100 - 10.000 LITRES)
- 74. **SC/E:** GALVANIZED TANK FOR COLD WATER, WITHOUT CE CERTIFICATION (100 - 5.000 LITRES)
- 76. **AR:** GLASSLINED ACCUMULATORS FOR CHILLED WATER (100 - 5.000 LITRES)
- 78. **ARZ:** GLASSLINED ACCUMULATORS FOR CHILLED WATER (100-5.000 LITRES)

81. HOT WATER TANKS - ACCUMULATORS

- 84. HOW TO SELECT THE VOLUME OF AN ELBI HOT WATER CYLINDER-ACCUMULATOR
- 86. **BSH:** GLASSLINED CYLINDER WITH FIXED HEAT EXCHANGER FOR SANITARY HOT WATER, WALL MOUNTING (100 - 300 LITRES)
- 88. **BSH:** THERMAL YIELD AND HYDRAULIC DIAGRAMS

- 90. BSV:** GLASSLINED CYLINDER WITH FIXED HEAT EXCHANGER FOR SANITARY HOT WATER (150 - 2.000 LITRES)
- 93. BSV:** THERMAL YIELD AND HYDRAULIC DIAGRAMS
- 96. BSP:** GLASSLINED DHW CYLINDER WITH FIXED EXCHANGER FOR HEAT PUMPS (300-1000 LITRES)
- 98. BSP:** THERMAL YIELD AND HYDRAULIC DIAGRAMS
- 100. BSM:** HIGH PERFORMANCES GLASSLINED CYLINDER WITH FIXED HEAT EXCHANGER FOR SANITARY HOT WATER (150 - 1.000 LITRES)
- 103. BSM:** THERMAL YIELD AND HYDRAULIC DIAGRAMS
- 106. BST:** GLASSLINED CYLINDER FOR SOLAR THERMAL USE WITH TWO FIXED EXCHANGERS (200 - 2.000 LITRES)
- 110. BST:** THERMAL YIELD AND HYDRAULIC DIAGRAMS
- 114. BSPT:** GLASSLINED DHW CYLINDER WITH TWO FIXED EXCHANGERS FOR HEAT PUMPS (300-1.000 LITRES)
- 116. BSPT:** THERMAL YIELD AND HYDRAULIC DIAGRAMS
- 118. BXV:** STAINLESS STEEL CYLINDER WITH FIXED HEAT EXCHANGER FOR SANITARY HOT WATER (170 - 1.000 LITRES)
- 121. BXV:** THERMAL YIELD AND HYDRAULIC DIAGRAMS
- 124. BXP:** STAINLESS STEEL DHW CYLINDER WITH FIXED EXCHANGER FOR HEAT PUMPS (300-1.000 LITRES)
- 126. BXP:** THERMAL YIELD AND HYDRAULIC DIAGRAMS
- 128. BXT:** STAINLESS STEEL CYLINDER WITH TWO FIXED HEAT EXCHANGERS FOR SOLAR THERMAL USE (200 - 1.500 LITRES)
- 132. BXT:** THERMAL YIELD AND HYDRAULIC DIAGRAMS
- 136. BXPT:** STAINLESS STEEL DHW CYLINDER WITH TWO FIXED EXCHANGERS FOR HEAT PUMPS (300-1.000 LITRES)
- 138. BXPT:** THERMAL YIELD
- 140. SXC:** STAINLESS STEEL ACCUMULATORS FOR SANITARY HOT WATER (100-900 LITRES)
- 143. SXC:** HYDRAULIC DIAGRAMS
- 144. COMBI:** MULTY ENERGY BUFFER TANKS FOR STORAGE OF HOT WATER FOR HEATING & DHW PRODUCTION (500 - 1.000 LITRES)
- 147. COMBI:** THERMAL YIELD AND HYDRAULIC DIAGRAMS
- 150. COMBI QUICK:** MULTY ENERGY BUFFER TANKS FOR STORAGE OF HOT WATER FOR HEATING & INSTANT DHW PRODUCTION (500 - 1.000 LITRES)
- 153. COMBI QUICK:** THERMAL YIELD AND HYDRAULIC DIAGRAMS
- 156. BF1:** GLASSLINED CYLINDERS WITH REMOVABLE STAINLESS STEEL HEAT EXCHANGER (1.500 - 5.000 LITRES)
- 159. BF1:** THERMAL YIELD AND HYDRAULIC DIAGRAMS
- 162. BF2:** GLASSLINED CYLINDERS WITH TWO REMOVABLE STAINLESS STEEL HEAT EXCHANGERS (1.500 - 5.000 LITRES)
- 165. BF2:** THERMAL YIELD AND HYDRAULIC DIAGRAMS
- 168. BF3:** GLASSLINED CYLINDERS WITH THREE REMOVABLE STAINLESS STEEL HEAT EXCHANGERS (1.500 - 5.000 LITRES)
- 171. BF3:** THERMAL YIELD AND HYDRAULIC DIAGRAMS
- 174. BG:** MULTI-PURPOSE GLASSLINED BUFFER TANKS WITH TRIPLE FLANGED OPENINGS (800 - 5.000 LITRES)
- 177. BG:** THERMAL YIELD AND HYDRAULIC DIAGRAMS

- 180. SAC:** GLASSLINED ACCUMULATORS FOR SANITARY HOT WATER (300 - 5.000 LITRES)
- 184. PUFFER:** HEATED WATER BUFFER TANKS FOR HEATING APPLICATIONS (300 - 5.000 LITRES)
- 188. PUFFER PLUS:** HEATED WATER BUFFER TANKS FOR HEATING APPLICATIONS WITH MULTIPLE CONNECTIONS (100 - 5.000 LITRES)
- 192. ACP:** INERTIAL ACCUMULATORS FOR HEAT PUMPS WALL MOUNTING (35 - 50 LITRES)
- 194. ACF:** THERMAL FLYWHEEL FOR AIR CONDITIONING/HEATING SYSTEMS (100-5.000 LITRES)
- 196. PPS1:** BUFFER TANK FOR HEATING SYSTEMS WITH FIXED SPIRAL COIL FOR HEATING APPLICATIONS (300 - 2.000 LITRES)
- 198. PPS1:** THERMAL YIELD AND HYDRAULIC DIAGRAMS
- 200. PPS2:** BUFFER TANK FOR HEATING SYSTEMS WITH TWO FIXED SPIRAL COILS FOR HEATING APPLICATIONS (300 - 2.000 LITRES)
- 204. BSE:** GLASSLINED ACCUMULATORS FOR SANITARY HOT WATER WITH PLATE HEAT EXCHANGERS (300-2.000 LITRES)
- 206. BSE:** THERMAL YIELD AND HYDRAULIC DIAGRAMS
- 208. SPI:** GASKETED PLATE HEAT EXCHANGERS
- 210. SSB:** BRAZED PLATE HEAT EXCHANGERS
- 212.** TABLE OF HEATING ELEMENT APPLICABILITY TO CYLINDERS
- 213.** MAINTENANCE OF GLASSLINED CYLINDERS

215. ASME TANKS

- 218. AS-ASME:** AIR SEPARATORS (WITH OR WITHOUT STRAINER)
- 220. DT-THERMAL EXPANSION TANKS:** FOR SANITARY WATER
- 222. HT-HYDRONIC HEATING EXPANSION TANKS:** FOR HEATING SYSTEMS (150 PSI)
- 224. WTL-2 HYDRONIC HEATING EXPANSION TANKS:** SANITARY BLADDER AUTOCLAVES FOR COLD WATER (200 PSI)
- 225.** DIAGRAM OF PRESSURE DROPS FOR AIR SEPARATORS

227. ACCESSORIES AND SPARE PARTS

234. GENERAL CONDITIONS OF SALE

**SYMBOLS IN THE HYDRAULIC DIAGRAMS
ARE LISTED IN THE SHUTTER OF THE COVER**



BLADDER AUTOCLAVES FOR SANITARY WATER

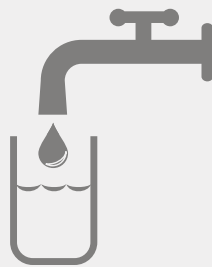

BLADDER AUTOCLAVES FOR SANITARY WATER

WHAT IT IS AND HOW IT WORKS

The accumulator vessel with replaceable bladder is a device that fitted into a pressurised water system will provide system water at a pre-set, sustained pressure. Its most common application is to supply systems in which the main supply pressure is too low and a pump is fitted to boost the pressure to an acceptable level.

As system demands take place the accumulator vessel will sustain system pressure by feeding additional water into the system at the required pressure. This process will limit the number of times the pump needs to start (pump hunting) in order that system pressure remains at the optimum level.

The process is achieved by the addition of a pre-charged air cushion at higher than atmospheric pressure within the vessel shell. This pre-charged cushion is stored between the water bladder and the inner surface of the tank. Any water pressure rise (pumping) causes the cushion to be additionally compressed. As system demands arise the nitrogen cushion forces the water from the bladder into the system thus maintaining optimum system pressure.

As the retained pressure finally exhausts and system pressure falls a pressure switch will turn the pump on, re-pressurising the system and the accumulator ready for further use.

This way the accumulator will prevent the need for the pump to start every time there is a demand on the water system and will flatten the system pressure curve at the optimum pressure.

Elbi accumulator vessels with replaceable bladders are the result of 50 years of experience in the design, manufacture and installation of tanks in hydraulic systems. The range is currently the most complete on the market in terms of product availability. The range has been subdivided into various series, each of which is designed for the various applications required by modern systems technology. All the products have been designed to comply with the most stringent international standards, mainly through the use of the latest design technology and industrial automation. The Elbi plants are on the edge of technological solutions with regard to design, production, automated welding and robot manufacturing systems.

All manufacturing processes are carried out within the Elbi plant facilities, including bladder production, which is critical as it determines the operation, life cycle and performance of the finished product. Elbi accumulators with replaceable bladder are manufactured from the highest quality UNI standard steel plate and welded using certified materials and procedures.

The versions for water-pressurisation systems, comprising the AS, AC, AF and DL series, come in capacities ranging from 2 to 5000 litres. All the models have been designed to hold potable (drinking) water and each features specific technical options to prevent the liquid from coming in contact with the inner surface of the tank. Over the years

Elbi has become one of the undisputed leaders in the achievement of stringent quality standards in terms of its sanitary procedures.

All the models are designed to contain drinking water and each model offers particular manufacturing solutions to eliminate contact of the liquid with the metal parts of the tank.

Elbi's decades of experience in international markets has led to the manufacture of products that comply with a wide range of international regulations (CE, ASME).

Elbi accumulators with replaceable bladders also come in tailored-made versions that reflect the latest evolution of the market. Special attention paid to emerging consumer requirements has led to the implementation of the HI-NOX series, entirely made up of stainless steel. These vessels are particularly suited for use in aggressive environments (sea, corrosive, etc.). The technical solutions used during design of these vessels make the HI-NOX series a reference standard for bladder-equipped tanks.

Financial benefits

Unlike standard air-cushioned accumulators without bladder, the accumulators with bladders feature the following advantages:

- **energy saving** reduced number of pump start-ups;
- **installation cost reduction** lack of water contact means that air is no longer dispersed into the water and therefore, there is no further need to supply a compressor to restore the cushion;
- **maintenance costs reduction** only the tank pre-charge pressure has to be checked. Additionally the bladder can be replaced, disassembled and reassembled easily in a very short time;
- **stored volume reduction** space saving;
- **water contamination risk is reduced** the bladder also serves as protection against any substance suspended in the air, such as: oil, smoke, bacteria, smells, dust, etc. that may alter the quality of water. Bladders are certified for alimentary use;
- **long-lasting** tank the fact that the bladder prevents water from being in direct contact with the inner surface of the tank significantly reduces corrosion;
- **dual purpose** this type of tank will also cushion water hammer.

BLADDER AUTOCLAVES FOR SANITARY WATER

16. AS/AC-CE:

REPLACEABLE BLADDER AUTOCLAVES FOR
SANITARY WATER (2 - 25 LITRES)

18. AF-CE:

REPLACEABLE BLADDER AUTOCLAVES FOR
SANITARY WATER (35 - 500 LITRES)

22. AFV-Z-CE:

GALVANIZED AUTOCLAVES WITH REPLACEABLE
BLADDER, FOR SANITARY WATER (60 - 500
LITRES)

24. HI-NOX-CE:

STAINLESS STEEL AUTOCLAVES WITH
REPLACEABLE BLADDER, FOR SANITARY WATER
(0,16 - 60 LITRES)

26. AUTOCLAVE EFFICIENCY

27. HOW TO SIZE A BLADDER AUTOCLAVE





AS/AC-CE

REPLACEABLE BLADDER AUTOCLAVES FOR SANITARY WATER

(2 -25 LITRES)

AS 25

AC-2

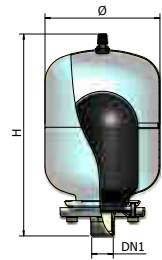
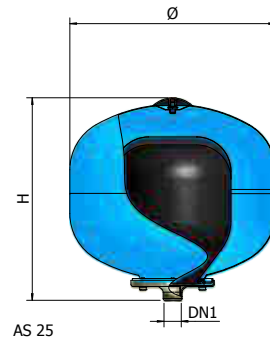

AC 25 GPM

AC 5-25; AFV 24

AC 20 PN25

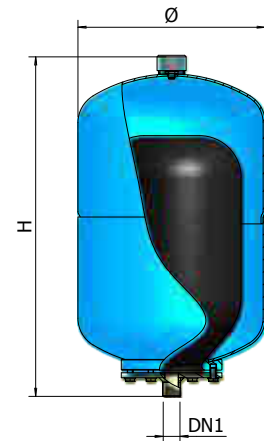
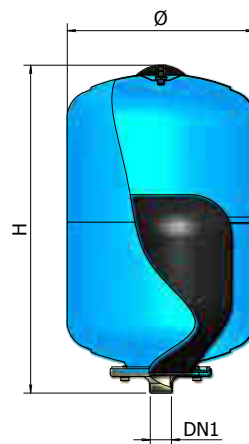
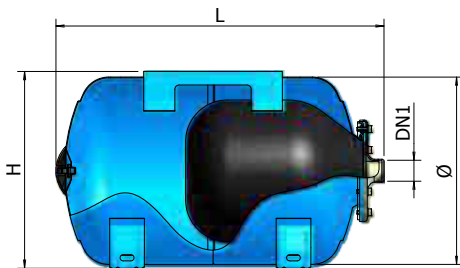

CE certified product



For drinking water



For pressurisation systems

The AS-AC series replacement bladder tanks are a valid solution for small household installations, garden irrigation systems and all other applications where small capacities are required.

All the models are supplied as standard with a bladder in EPDM; this means they can also be used as sanitary expansion tanks up to a maximum design temperature of +99°C.

The AS-25 model combines practicality and financial benefits, and is suitable for direct installation on the pump.

The AC GPM-25 model has been designed to implement small, compact type pressurization units. CE certified.

Characteristics:

• Working temperature: -10° / +99°C (Mod. AC20 PN25: -10° / + 50°C)

• Blue epoxy powder paint. (Model AC-2: white)

• Replaceable bladder in EPDM rubber (Model AC-2: replaceable bladder in butyl)

• Water and air completely separate.

• No contact between water and tank inner surface.

• Replaceable alimentary non-toxic bladder with elastic characteristics to enable total expansion inside the tank to ensure the best performance and longer product life cycle.

Reference standard:

• Declaration of conformity to essential safety requirements specified in 2014/68/UE Directive. (The 2 and 5 litre models are exempt from CE marking).

WARRANTY: 2 YEARS

DIMENSIONS

MODEL	CODE	Ppre Pmax			DN1			mm	NOTES		
		LITRES	bar	bar	max	mm	mm			mm	
AC-2 *	A012J07	2	2,5	8	+99°C	130	230	-	3/4"	150 x 150 x 240	
AC 5 *	A012J11	5	2,5	8	+99°C	205	240	-	3/4"	210 x 210 x 250	
AC 8 CE	A012J16	8	2,5	8	+99°C	205	315	-	3/4"	210 x 210 x 320	
AC 18 CE	A012J24	18	2,5	8	+99°C	270	430	-	1"	280 x 280 x 450	
AC 25 CE	A012J27	24	2,5	8	+99°C	270	480	-	1"	280 x 280 x 470	
AC 25 GPM CE	A022J27	24	2,5	8	+99°C	270	290	480	1"	280 x 300 x 470	
AS 25 CE	A002J27	24	2,5	8	+99°C	360	365	-	1"	360 x 360 x 380	
AC 20 PN25 CE	A012T25	20	5	25	+50°C	270	495	-	3/4"	280 x 280 x 500	
AFV 24/16 CE	A032R27	24	2,5	16	+99°C	270	480	-	1"	280 x 280 x 470	

* Exempt from CE marking

STAINLESS STEEL COUNTER-FLANGE VERSION

MODEL	CODE	Ppre Pmax			DN1			mm	NOTES		
		LITRES	bar	bar	max	mm	mm			mm	
AC-18X	A012J24 WR000	18	2,5	8	+99°C	270	430	-	1"	280 x 280 x 450	
AC-25X	A012J27 WR000	24	2,5	8	+99°C	270	480	-	1"	280 x 280 x 470	
AC-25X GPM	A022J27 WR000	24	2,5	8	+99°C	270	290	480	1"	280 x 300 x 470	
AS-25X	A002J27 WR000	24	2,5	8	+99°C	360	365	-	1"	360 x 360 x 380	
AC-20X	A012T25 WR000	20	5	25	+50°C	270	495	-	3/4"	280 x 280 x 500	
AFV-24X	A032R27 WR000	24	2,5	16	+99°C	270	480	-	1"	280 x 280 x 470	

Bladder accumulator selection chart

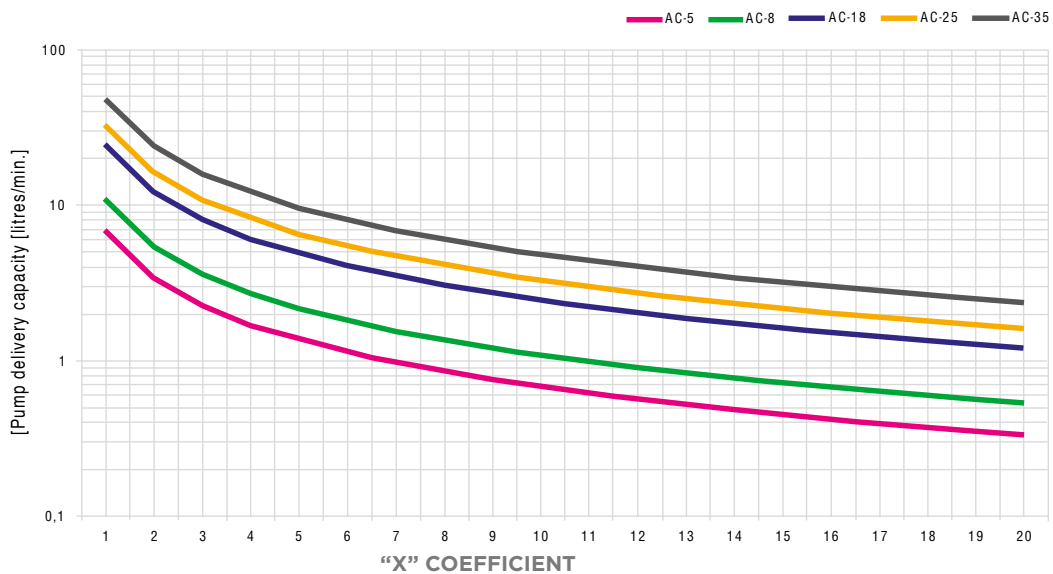

To make sizing easier, a chart has been drawn up to select the most appropriate accumulator according to both the working pressure and delivery criteria. Note that the chart is based on the following hypothesis: standard precharge and 15 pump starts per hour (see p. 27 to identify the "X" coefficient).

Maximum delivery capacity of the pump [litres/min.]	Δp System working pressure											
	1,5 - 3,0			2,0 - 3,5			2,5 - 4,0			2,5 - 4,0		
	Number of pump starts per hour											
	15	8	5	15	8	5	15	8	5	15	8	5
2	5	8	18	8	18	24	8	18	35	5	8	18
8	18	35	50	24	50	80	80	35	100	24	50	80
10	24	50	60	35	60	100	100	50	150	35	50	100



AF-CE

REPLACEABLE BLADDER AUTOCLAVES FOR SANITARY WATER

(35 - 500 LITRES)

AFV 500 16 BAR

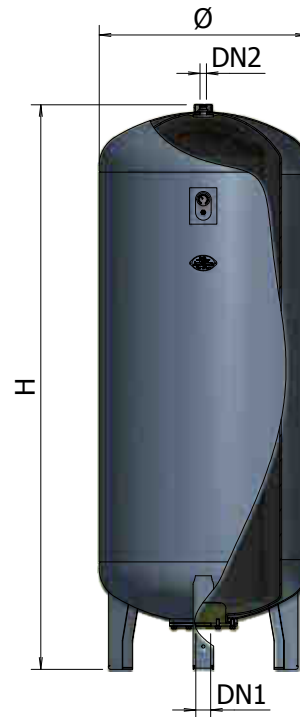

AFV 50 - 500

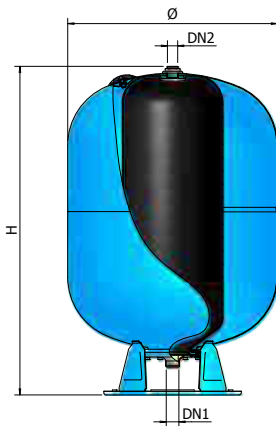

AFH 50 - 300

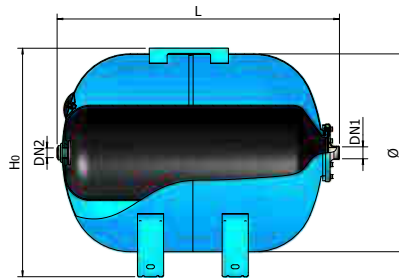

AF35

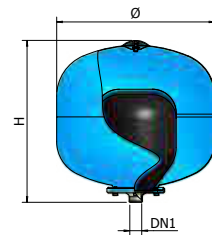

CE certified product

For drinking water

For pressurisation systems

The AF series replaceable bladder tanks are suitable for most residential and industrial installations where considerable water capacities are required. The standard version supplied is 10 bar. CE certified, the AF series autoclaves are also available in customized versions in compliance with the most important international standards. The horizontal version is equipped with an universal engine support bracket to allow the pump to be fastened directly above the tank.

Valve and gauge supplied on request, see "Accessories and Spare Parts" section.

Galvanized version available from 60 to 500 litres (see AFV-Z serie)

Characteristics:

- Working temperature: -10° / +99°C.
- Alimentary tested EPDM rubber bladder, with elastic characteristics to enable total expansion inside the tank to ensure the best performance and longer product life cycle.
- Epoxy powder paint with long duration for better protection against atmospheric agents. Blue. Model AFV 500 16 Bar, solvent-based paint, grey.
- Water and air completely separate.
- Water completely separate from metal parts of the tank.
- AFV 50 and AFH 50 models without tie rod

Reference standard:

Declaration of conformity to essential safety requirements specified in 2014/68/UE Directive.

WARRANTY: 2 YEARS

DIMENSIONS

MODEL	CODE	Ppre Pmax				DN1 DN2			mm	NOTES	
		LITRES	bar	bar	max	mm	mm	mm			
AF 35 CE	A032L31	35	2,5	10	+99°C	400	440	-	1"	-	410 x 410 x 410
AF 50 CE	A052L34	50	2,5	10	+99°C	400	525	-	1"	-	410 x 410 x 535
AFV 50 CE	A032L34	50	2,5	10	+99°C	400	570	-	1"	-	410 x 410 x 610
AFV 60 CE	A032L35	60	2,5	10	+99°C	400	700	-	1"	1/2"F 3/4"M	410 x 410 x 760
AFV 80 CE	A032L37	80	2,5	10	+99°C	400	810	-	1"	1/2"F 3/4"M	410 x 410 x 860
AFV 100 CE	A032L38	100	2,5	10	+99°C	500	740	-	1"	1/2"F 3/4"M	510 x 510 x 830
AFV 150 CE	A032L43	150	2,5	10	+99°C	500	945	-	1"	1/2"F 3/4"M	510 x 510 x 1040
AFV 200 CE	A032L47	200	2,5	10	+99°C	600	1035	-	1"1/4	1/2"F 3/4"M	610 x 610 x 1110
AFV 300 CE	A032L51	300	2,5	10	+99°C	650	1215	-	1"1/4	1/2"F 3/4"M	660 x 660 x 1290
AFV 500 CE	A032L55	500	2,5	10	+99°C	775	1360	-	1"1/4	1/2"F 3/4"M	785 x 785 x 1440
AFH 50 CE	A042L34	50	2,5	10	+99°C	400	420	505	1"	-	410 x 530 x 440
AFH 60 CE	A042L35	60	2,5	10	+99°C	400	485	650	1"	1/2"F 3/4"M	410 x 685 x 490
AFH 80 CE	A042L37	80	2,5	10	+99°C	400	485	745	1"	1/2"F 3/4"M	410 x 775 x 490
AFH 100 CE	A042L38	100	2,5	10	+99°C	500	580	680	1"	1/2"F 3/4"M	510 x 730 x 600
AFH 200 CE	A042L47	200	2,5	10	+99°C	600	685	960	1"1/4	1/2"F 3/4"M	610 x 950 x 680
AFH 300 CE	A042L51	300	2,5	10	+99°C	650	725	1145	1"1/4	1/2"F 3/4"M	660 x 1140 x 720
AFV 100 ₁₆ CE	A032R38	100	2,5	16	+99°C	500	740	-	1"	1/2"F 3/4"M	510 x 510 x 830
AFV 200 ₁₆ CE	A032R47	200	2,5	16	+99°C	600	1035	-	1"1/4	1/2"F 3/4"M	610 x 619 x 1110
AFV 300 ₁₆ CE	A032R51	300	2,5	16	+99°C	650	1215	-	1"1/4	1/2"F 3/4"M	660 x 660 x 1290
AFV 500 ₁₆ CE	A032R55	500	2,5	16	+99°C	650	1865	-	G 2"	1/2"F 3/4"M	-

For larger tanks see the DL series

STAINLESS STEEL COUNTER-FLANGE VERSION

MODEL	CODE	Ppre Pmax				DN1 DN2			mm	NOTES	
		LITRES	bar	bar	max	mm	mm	mm			
AF 35 X	A032L31 WR000	35	2,5	10	+99°C	400	440	-	1"	-	410 x 410 x 410
AF 50 X	A052L34 WR000	50	2,5	10	+99°C	400	525	-	1"	-	410 x 410 x 535
AFV 50 X	A032L34 WR000	50	2,5	10	+99°C	400	570	-	1"	-	410 x 410 x 610
AFV 60 X	A032L35 WR000	60	2,5	10	+99°C	400	700	-	1"	1/2"F 3/4"M	410 x 410 x 760
AFV 80 X	A032L37 WR000	80	2,5	10	+99°C	400	810	-	1"	1/2"F 3/4"M	410 x 410 x 860
AFV 100 X	A032L38 WR000	100	2,5	10	+99°C	500	740	-	1"	1/2"F 3/4"M	510 x 510 x 830
AFV 150 X	A032L43 WR000	150	2,5	10	+99°C	500	945	-	1"	1/2"F 3/4"M	510 x 510 x 1040
AFV 200 X	A032L47 WR000	200	2,5	10	+99°C	600	1035	-	1"1/4	1/2"F 3/4"M	610 x 610 x 1110
AFV 300 X	A032L51 WR000	300	2,5	10	+99°C	650	1215	-	1"1/4	1/2"F 3/4"M	660 x 660 x 1290
AFV 500 X	A032L55 WR000	500	2,5	10	+99°C	775	1360	-	1"1/4	1/2"F 3/4"M	785 x 785 x 1440
AFH 50 X	A042L34 WR000	50	2,5	10	+99°C	400	420	505	1"	-	410 x 530 x 440
AFH 60 X	A042L35 WR000	60	2,5	10	+99°C	400	485	650	1"	1/2"F 3/4"M	410 x 685 x 490
AFH 80 X	A042L37 WR000	80	2,5	10	+99°C	400	485	745	1"	1/2"F 3/4"M	410 x 775 x 490
AFH 100 X	A042L38 WR000	100	2,5	10	+99°C	500	580	680	1"	1/2"F 3/4"M	510 x 730 x 600
AFH 200 X	A042L47 WR000	200	2,5	10	+99°C	600	685	960	1"1/4	1/2"F 3/4"M	610 x 950 x 680
AFH 300 X	A042L51 WR000	300	2,5	10	+99°C	650	725	1145	1"1/4	1/2"F 3/4"M	660 x 1140 x 720
AFV 100 ₁₆ X	A032R38 WR000	100	2,5	16	+99°C	500	740	-	1"	1/2"F 3/4"M	510 x 510 x 830
AFV 200 ₁₆ X	A032R47 WR000	200	2,5	16	+99°C	600	1035	-	1"1/4	1/2"F 3/4"M	610 x 619 x 1110
AFV 300 ₁₆ X	A032R51 WR000	300	2,5	16	+99°C	650	1215	-	1"1/4	1/2"F 3/4"M	660 x 660 x 1290

VERSION WITHOUT CE MARK

MODEL	CODE	Ppre Pmax				DN1 DN2			mm	NOTES	
		LITRES	bar	bar	max	mm	mm	mm			
AFV 100 ₁₆	A030R38 EXP00	100	2,5	16	+99°C	500	740	-	1"	1/2"F 3/4"M	510 x 510 x 830
AFV 200 ₁₆	A030R47 EXP00	200	2,5	16	+99°C	600	1035	-	1"1/4	1/2"F 3/4"M	610 x 619 x 1110
AFV 300 ₁₆	A030R51 EXP00	300	2,5	16	+99°C	650	1215	-	1"1/4	1/2"F 3/4"M	660 x 660 x 1290
AFV 500 ₁₆	A030R55 EXP00	500	2,5	16	+99°C	650	1865	-	G2"	1/2"F 3/4"M	-

Bladder accumulator selection chart

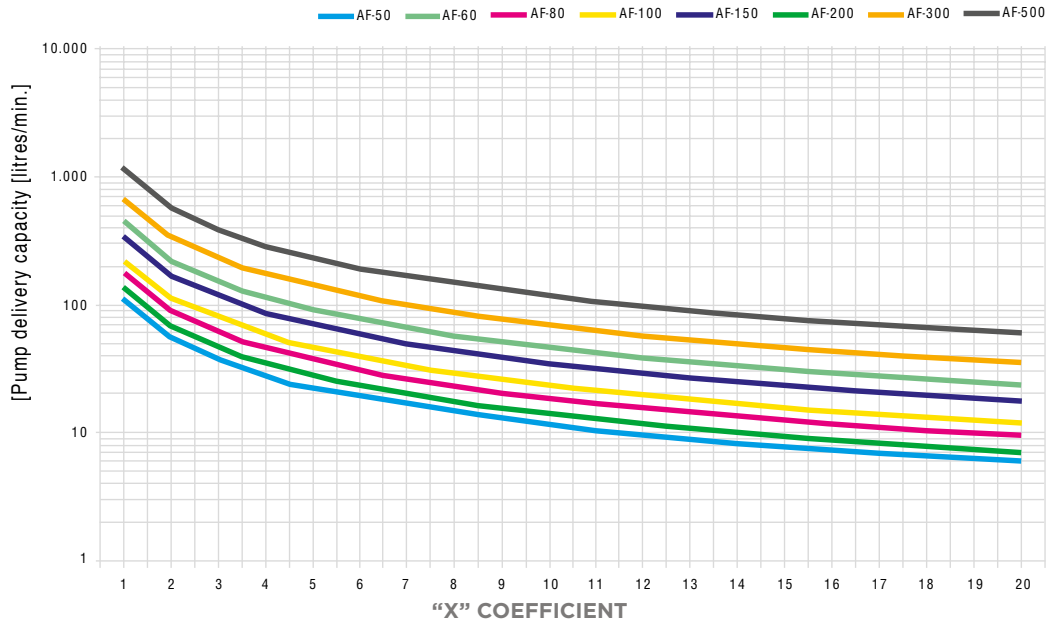

To make sizing easier, a chart has been drawn up to select the most appropriate accumulator according to both working pressure and delivery criteria. Note that the chart is based on the following hypothesis: standard precharge and 15 pump starts per hour (see p. 27 to identify the "X" coefficient)

Maximum delivery capacity of the pump [litres/min.]	Δp System working pressure											
	1,5 - 3,0			2,0 - 3,5			2,5 - 4,0			2,5 - 4,0		
	Number of pump starts per hour											
	15	8	5	15	8	5	15	8	5	15	8	5
10		50	60	35	50	100	50	100	150	35	50	80
20	50	80	150	60	100	200	100	200	300	50	100	200
25	60	100	150	80	150	250	150	250	300	80	150	250
40	100	200	250	150	250	500	200	300	500	100	250	300
45	100	200	300	150	200	500	250	500	-	150	250	500
55	150	250	300	200	300	500	300	500	-	150	300	500
75	200	300	500	250	500	-	300	-	-	200	500	-
95	200	500	-	300	500	-	500	-	-	300	500	-
115	250	500	-	500	-	-	500	-	-	300	-	-
150	300	-	-	500	-	-	-	-	-	500	-	-
200	500	-	-	-	-	-	-	-	-	-	-	-





AFV-Z - CE

GALVANIZED AUTOCLAVES WITH REPLACEABLE BLADDER, FOR SANITARY WATER

(60 - 500 LITRES)

AFV-Z 60 - 500

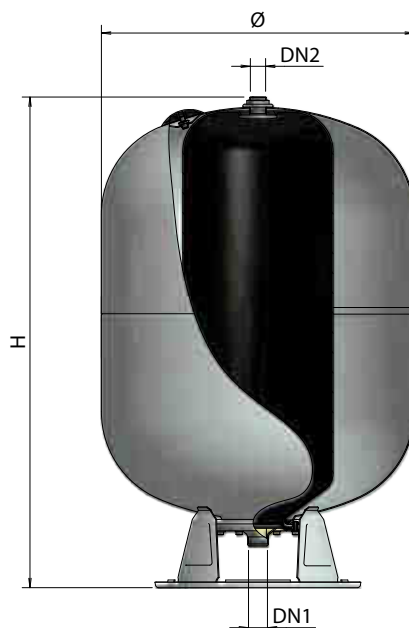

CE certified product

For drinking water

For pressurisation systems

Galvanized

Characteristics:

- Working temperature: -10° / +99°C.
- Alimentary tested EPDM rubber bladder, with elastic characteristics to enable total expansion inside the tank to ensure the best performance and longer product life cycle.
- Water and air completely separate.
- Water completely separate from metal parts of the tank.

Reference standard:

- Declaration of conformity to essential safety requirements specified in 2014/68/UE Directive.

The AF series replaceable bladder tanks are suitable for most residential and industrial installations where considerable water capacities are required. The standard version supplied is 10 bars. CE certified. Safety valve and gauge supplied on request.

WARRANTY: 2 YEARS

MODEL	CODE	LITRES	Ppre	Pmax	max	mm	mm	mm	DN1	DN2	mm	NOTES
AFV-Z 60 CE	A072L35	60	2,5	10	+99°C	400	700	-	1"	1/2"F 3/4"M	410 x 410 x 760	
AFV-Z 80 CE	A072L37	80	2,5	10	+99°C	400	810	-	1"	1/2"F 3/4"M	410 x 410 x 860	
AFV-Z 100 CE	A072L38	100	2,5	10	+99°C	500	740	-	1"	1/2"F 3/4"M	510 x 510 x 830	
AFV-Z 150 CE	A072L43	150	2,5	10	+99°C	500	945	-	1"	1/2"F 3/4"M	510 x 510 x 1040	
AFV-Z 200 CE	A072L47	200	2,5	10	+99°C	600	1035	-	1"1/4	1/2"F 3/4"M	610 x 610 x 1110	
AFV-Z 300 CE	A072L51	300	2,5	10	+99°C	650	1215	-	1"1/4	1/2"F 3/4"M	660 x 660 x 1290	
AFV-Z 500 CE	A072L55	500	2,5	10	+99°C	775	1360	-	1"1/4	1/2"F 3/4"M	785 x 785 x 1440	





HI-NOX-CE

STAINLESS STEEL AUTOCLAVES WITH REPLACEABLE BLADDER, FOR SANITARY WATER

(0,16-50 LITRES)

HX-016



HX-05



HX-1



HX-2



HM-8



HM 24



HM 60 V

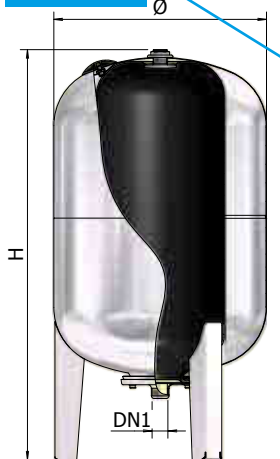

HM 24 GPM; HM 60 H



- CE certified product
- For drinking water
- Stainless steel body
- For pressurisation systems

The stainless steel tanks offer top quality in the Elbi range. Designed as a stand-alone product, therefore not only as a simple variant of similar products in carbon steel, HI-NOX tanks are built based on the right processing techniques for stainless steel with manufacturing involving specifically designed equipment to process stainless steel. Particular attention was also given to the overall aesthetic appearance and product polishing.

Characteristics:

- Working temperature: -10° / +99°C
- Models up to 8 litres with fixed-bladder, exempt from CE marking. They are particularly indicated for use as a water hammer arrestor.
- The models from 24 litres are indicated for use in small water lifting units where the qualitative and hygienic appearance of the water is important.
- All the bladder tanks in the HI-NOX are supplied as standard with an EPDM bladder. (Models from 0,16 to 2 litres with butyl bladder).

Reference standard:

- Declaration of conformity to essential requirements specified in 2014/68/UE Directive.

WARRANTY: 2 YEARS

DIMENSIONS

MODEL	CODE		Ppre Pmax						DN1		NOTES
		LITRES	bar	bar	max	mm	mm	mm		mm	
HX - 016*	AOD0Q01	0,16	3,5	15	+99°C	75	105	-	1/2"	85 x 85 x 115	
HX - 05*	AOD0L03	0,5	3,5	10	+99°C	95	160	-	1/2"	105 x 105 x 170	
HX - 1*	AOD0L05	1	3,5	10	+99°C	115	200	-	1/2"	125 x 125 x 210	
HX - 2*	AOD0L07	2	3,5	10	+99°C	135	220	475	1/2"	145 x 145 x 230	
HM - 8*	AOD2L16	8	2	10	+99°C	200	340	655	3/4"	210 x 210 x 350	
HM 24 CE	AOA2L27	24	2,5	10	+99°C	270	480	-	1"	280 x 280 x 470	
HM 24 GPM CE	AOB2L27	24	2,5	10	+99°C	270	290	480	1"	280 x 470 x 300	
HM 60V CE	AOA2L35	60	2,5	10	+99°C	400	775	-	1"	410 x 410 x 860	
HM 60H CE	AOB2L35	60	2,5	10	+99°C	400	480	655	1"	410 x 650 x 500	

* Exempt from CE marking



Autoclave efficiency is the quantity of water that the bladder tank can supply within the maximum (p2) and minimum (p1) working pressure of the pump.

Called:

- Va=total volume of the pressure tank
- p1=switch (on) of the pump
- p2=switch (off) of the pump
- pc=air precharge pressure

NOTE: All pressure are referred to as gauge pressure.

The formula to calculate the efficiency of the tanks as follows:

$$R = \frac{(p2 - p1) \times (pc + 1)}{(p2 + 1) \times (pc + 1)} \times Va; \quad \text{Stated } pc = p1$$

$$R = \frac{(p2 - p1)}{(p2 + 1)} \times Va$$

Example:

- Va = 750 lt. p1 = 4 bar
- p2 = 5 bar pc = p1 = 4 bar

The autoclave efficiency is: $R = \frac{(5 - 4)}{(5 + 1)} \times 750 = 125 \text{ lt.}$ equal to 16%.

The efficiency diagram (Fig. 1) shows the efficiency in % according to the min. and max. working pressures of the pump

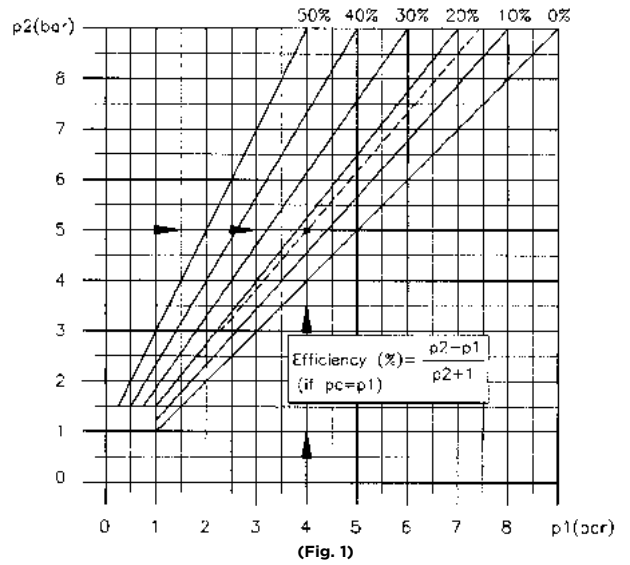

How to size a bladder autoclave

General formula to size a bladder autoclave:

$$Vt = 16,5 \times \frac{Q_{max}}{A} \times \frac{Ps \times Pa}{Ps - Pa} \times \frac{1}{Pp}$$

- Vt= Accumulator global volume [litres]
- Qmax= Pump max. delivery capacity or system maximum consumption [lt/min.] (12 - 15)
- A = Number of pump starts - stops per hour [bar]
- Ps= Pump stop (absolute) pressure [bar]
- Pa= Pump starting (absolute) pressure [bar]
- Pp= (absolute) precharge pressure (Pa - 0.5) [bar]

The pump may be sized according to two different techniques:

A. Sizing the accumulator by using the pump maximum delivery capacity

- Replace Qmax in the formula by the pump delivery capacity.
- The Pa pump starting pressure must be higher than the Pp precharge pressure.
- In order to optimise the accumulator yielding, the precharge pressure must be 0.5 bars lower than the pump starting pressure.

B. Sizing the accumulator by using the maximum consumption of the system:

- In that case, define the maximum consumption of users by applying the calculation method in accordance with UNI 9182;
- Identify types of users (shower, WC, sink, etc.) equipped on the system;
- Assess the number of users for each type;
- Refer to table 1 for private buildings and to table 2 for public buildings, calculate the number of total system charge units (CU) by multiplying each type of user by the corresponding CU listed in the table

TAB.1 PRIVATE BUILDINGS

UTILITIES	CU
Wash-basin	1
Bidet	1
Bath	2
Shower	2
Box toilet	3
Direct flush toilet	6
Kitchen sink	2
Washing machine	2
Dishwasher	2
Small hydrant 3/8"	1
Small hydrant 1/2"	2
Small hydrant 3/4"	3
Small hydrant	6

TAB.2 PUBLIC BUILDINGS

UTILITIES	CU
Wash-basin	2
Bidet	2
Bath	4
Shower	4
Box toilet	5
Direct flush toilet	10
Kitchen washbasin	4
Sink	3
Foot bath	2
Fountain	0,75
Small hydrant 3/8"	2
Small hydrant 1/2"	4
Small hydrant 3/4"	6
Small hydrant	10

Once the total charge units have been computed, turn them into litres per minute by referring to table 3.

TAB.3

CU CONVERSION TABLE (Litres/min.)

CU	Q [lt/min]	CU	Q [lt/min]	CU	Q [lt/min]
6	18	100	189	1250	930
8	24	120	219	1500	1050
10	30	140	234	1750	1128
12	36	160	255	2000	1230
14	40.8	180	276	2250	1320
16	46.8	200	297	2500	1410
18	51	225	321	2750	1470
20	55.8	250	345	3000	1560
25	67.8	275	366	3500	1680
30	78	300	387	4000	1830
35	87.6	400	468	4500	1950
40	97.2	500	540	5000	2070
50	114	600	600	6000	2280
60	132	700	660	7000	2460
70	144	800	714	8000	2640
80	159	900	774	9000	2820
90	174	1000	828	10000	3000

Once the system maximum consumption (Qmax) has been defined, proceed to size the accumulator by applying the corresponding formula

TAB.4

“X” COEFFICIENT

Pump stop pressure (bar) (max)	PUMP STARTING PRESSURE (bar) (min)					
	0,5	1	1,5	2	2,5	3
1	1					
1,5	0,7	3				
2	0,66	2	6			
2,5	0,62	1,66	3,75	10		
3	0,6	1,5	3	6	15	
3,5	0,58	1,4	2,65	4,66	8,75	21
4	0,57	1,33	2,4	4	6,66	12
4,5	0,56	1,28	2,25	3,6	5,62	9
5	0,55	1,25	2,14	3,33	5	7,5
5,5	0,55	1,22	2,06	3,14	4,58	6,6
6	0,54	1,2	2	3	4,28	6
6,5	0,541	1,181	1,95	2,88	4,06	5,57
7	0,538	1,16	1,90	2,8	3,88	5,25
7,5	0,53	1,15	1,87	2,72	3,75	4,5
8	0,53	1,14	1,84	2,66	3,63	4,8

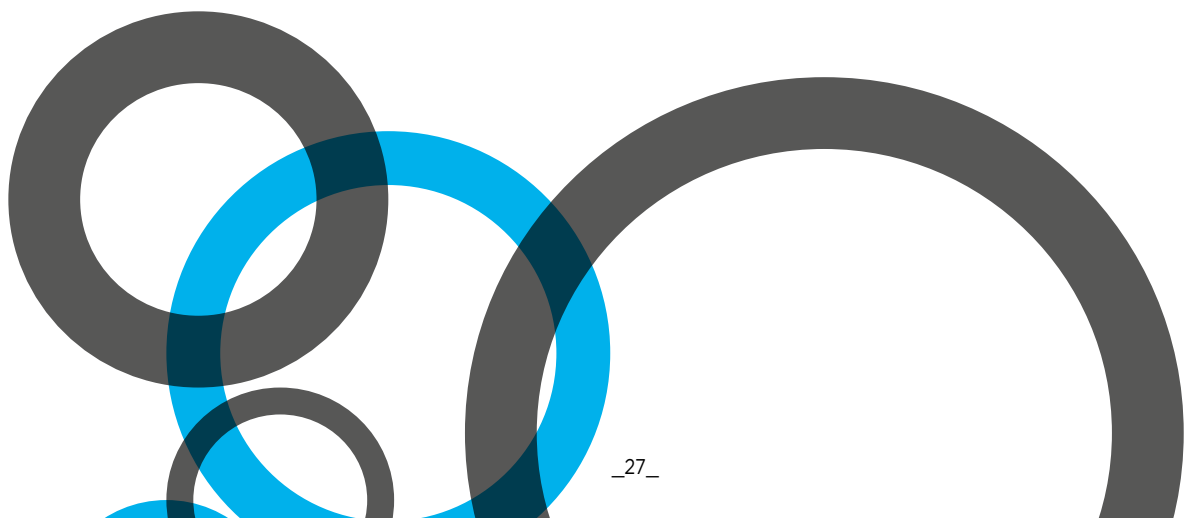



MULTI-FUNCTIONAL TANKS (HEATING / SANITARY WATER)

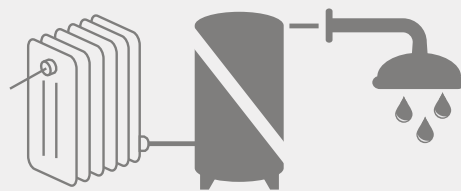

MULTI-FUNCTIONAL TANKS

The multi-functional bladder vessels have many uses:

- As expansion tanks for sanitary installations, therefore suitable to absorb the volume variations caused by the temperature
- As autoclaves in sanitary systems for cold water
- As water hammer arrestor to protect the equipment installed in the plant

Their construction with TOP-PRO(R) coating internal or with replaceable bladder, ensures the water does not come into contact with the tank wall, protecting against corrosion and ensuring suitability for contact with potable water.

The multi-functional tanks are CE approved as required by the 2014/68/EU European Directive.

MULTI-FUNCTIONAL TANKS (HEATING / SANITARY WATER)

32. AC-2 / D-CE:

MULTI-FUNCTIONAL SANITARY TANKS WITH
FIXED-BLADDER (2 - 500 LITRES)

34. DE-CE:

MULTIFUNCTIONAL TANKS WITH REPLACEABLE
BUTYL BLADDER (8 - 24 LITRES)

36. DL:

REPLACEABLE BLADDER MULTI-FUNCTIONAL
TANKS (750 - 5.000 LITRES)

38. MICRON:

WATER HAMMER ARRESTOR MINI TANK (160
ML)

40. SANY:

REPLACEABLE BLADDER SANITARY TANKS,
FOR SMALL SPACES (0.5 - 6 LITRES)



AC-2 / D-CE

MULTI-FUNCTIONAL SANITARY TANKS WITH FIXED BLADDER

(2 - 500 LITRES)



DV 50-500

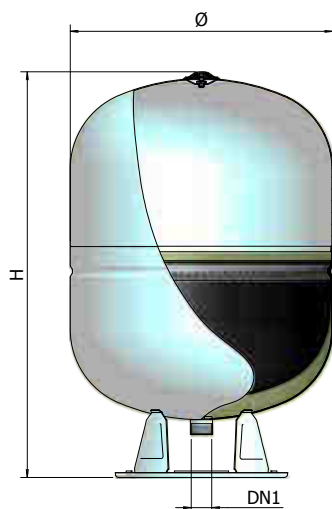

D5 - 35

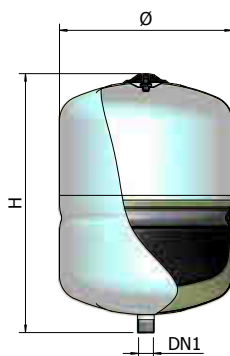

AC - 2

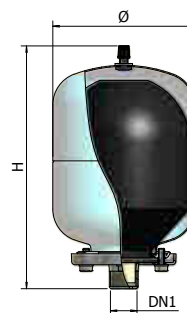

CE certified product



For drinking water



For sanitary hot water



For heating systems



For air conditioning systems



For pressurisation systems



Water hammer arrestor



Top-Pro® internal protection (NO AC-2)

Characteristics:

- Min./max. working temperature: -10° / +99°C
- Equipped with a fixed alimentary bladder in butyl (**model AC-2 with replaceable bladder**) that ensures permanent separation of the air cushion from the water;
- Internal protection of the water connection in Nylon 66;
- Long lasting epoxy powder paint, white;

Reference standard:

- Declaration in compliance with the essential requirements of 2014/68/UE Directive.
- (The 2 and 5 litre models are exempt from CE marking).

Fixed bladder multifunctional tanks

Multifunctional sanitary vessels with fixed bladder are designed to be fitted both into sanitary systems as expansion tanks, suitable to absorb the water expansion volume generated by a changing temperature, as well as pressure tanks for cold water sanitary systems.

Both applications are possible thanks to the exclusive Top-Pro® anti-corrosion treatment which ensures the protection against corrosion of the inner surface of the tank and the fitness of all parts in contact with water.

Installing a D series sanitary vessel considerably cuts down operating costs, while suppressing the discharge function of the safety valve.

In your Domestic Hot Water system install Elbi D-DV expansion tanks in the cold water supply pipe; do not install Elbi D-DV expansion tanks in the hot water draw-off pipe.

WARRANTY: 3 YEARS

DIMENSIONS

MODEL	CODE		Ppre	Pmax				DN1		NOTES
		LITRES	bar	bar	max	mm	mm	mm		
AC-2 *	A012J07	2	2,5	8	+99°C	130	230	3/4"	150 x 150 x 240	
D 5 *	A202L11	5	3	10	+99°C	205	215	3/4"	210 x 210 x 250	
D 8 CE	A202L16	8	3	10	+99°C	205	280	3/4"	210 x 210 x 320	
D 11 CE	A202L19	11	3	10	+99°C	270	300	3/4"	280 x 280 x 310	
D 18 CE	A202L24	18	3	10	+99°C	270	410	3/4"	280 x 280 x 450	
D 24 CE	A202L27	24	3	10	+99°C	320	330	1"	330 x 330 x 375	
D 35 CE	A202L31	35	3	10	+99°C	400	395	1"	410 x 410 x 410	
DV 50 CE	A212L34	50	3	10	+99°C	400	585	1"	410 x 410 x 610	
DV 80 CE	A212L37	80	3	10	+99°C	400	820	1"	410 x 410 x 860	
DV 100 CE	A212L38	100	3	10	+99°C	500	735	1 1/4"	510 x 510 x 830	
DV 150 CE	A212L43	150	3	10	+99°C	500	935	1 1/4"	510 x 510 x 1040	
DV 200 CE	A212L47	200	3	10	+99°C	600	1020	1 1/4"	610 x 610 x 1110	
DV 300 CE	A212L51	300	3	10	+99°C	650	1210	1 1/4"	660 x 660 x 1290	
DV 500 CE	A212L55	500	3	10	+99°C	775	1350	1 1/4"	785 x 785 x 1440	

* Exempt from CE marking

Bladder accumulator selection chart

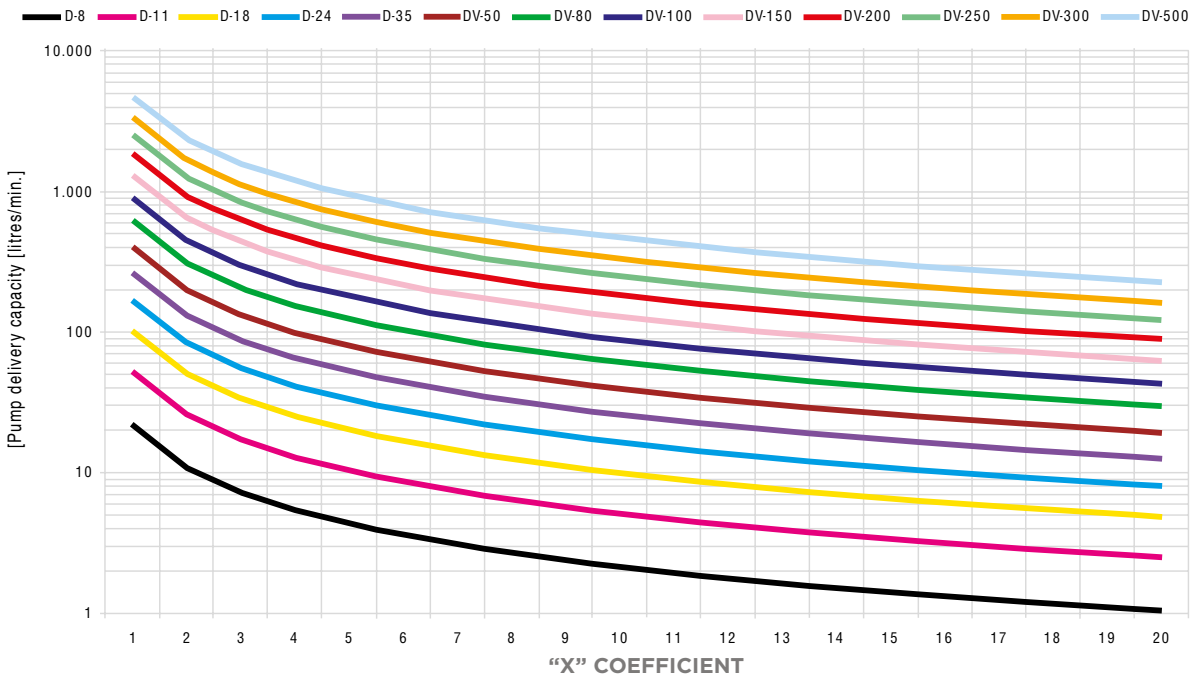

To make sizing easier, a chart has been drawn up to select the most appropriate accumulator according to both working pressure and delivery criteria. Note that the chart is based on the following hypothesis: standard precharge and 15 pump starts per hour (see p. 27 to identify the "X" coefficient).

Pump max delivery capacity [litres/min.]	Δp System working pressure								
	1,5 - 3,0			2,0 - 3,5			2,5 - 4,0		
	Number of pump starts per hour								
	15	8	5	15	8	5	15	8	5
10	D-35	DV-50	DV-50	D-35	DV-50	DV-80	D-35	DV-50	DV-80
20	DV-50	DV-80	DV-100	DV-80	DV-100	DV-150	DV-80	DV-100	DV-150
25	DV-80	DV-100	DV-150	DV-80	DV-150	DV-150	DV-100	DV-150	DV-200
40	DV-100	DV-200	DV-200	DV-150	DV-200	DV-300	DV-150	DV-200	DV-300
45	DV-150	DV-200	DV-300	DV-150	DV-200	DV-300	DV-150	DV-300	DV-300
55	DV-150	DV-300	DV-300	DV-200	DV-300	DV-500	DV-200	DV-300	DV-500
75	DV-200	DV-300	DV-500	DV-300	DV-500	DV-500	DV-300	DV-500	DV-500
95	DV-300	DV-500	DV-500	DV-300	DV-500	2XDV-300	DV-500	DV-500	2XDV-500
115	DV-300	DV-500	2XDV-300	DV-300	2XDV-300	2XDV-500	DV-500	2XDV-300	2XDV-500



DE-CE

MULTIFUNCTIONAL TANKS WITH REPLACEABLE BUTYL BLADDER

(8 - 24 LITRES)



DE - CE 8-24

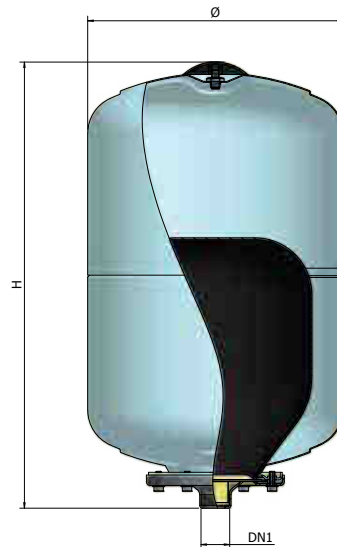

CE certified product



For drinking water



For sanitary hot water



For heating systems



For air conditioning systems



For pressurisation systems



Water hammer arrestor

Characteristics:

- Min./max. working temperature: -10° / +99°C
- Equipped with replaceable alimentary bladder in butyl
- Long lasting epoxy powder paint, white.

Reference standard:

- Declaration in compliance with the essential requirements of 2014/68/UE Directive.





Multifunctional tanks with replaceable butyl bladder

Multifunctional sanitary vessels with replaceable bladder are designed to be fitted both into sanitary systems as expansion tanks, suitable to absorb the water expansion volume generated by a changing temperature, as well as autoclaves for small residential installations, garden irrigation systems and all other applications where flow rates are requested, as well as pressure tanks for heating installations. The installation of a DE multifunctional tank reduces costs operating system and prevents the need to exhaust by the valve safety. Installing a DE series sanitary vessel considerably cuts down operating costs, while suppressing the discharge function of the safety valve.

In your Domestic Hot Water system install Elbi DE expansion tanks in the cold water supply pipe; do not install Elbi DE expansion tanks in the hot water draw-off pipe.

WARRANTY: 2 YEARS

DIMENSIONS

MODEL	CODE		P_{pre}	P_{max}				DN1		NOTES
		LITRES	bar	bar	max	mm	mm		mm	
DE-8	A2B2J16	8	3	8	+99°C	205	315	3/4"	210 x 210 x 320	
DE-18	A2B2J24	18	3	8	+99°C	270	430	1"	280 x 280 x 450	
DE-24	A2B2J27	24	3	8	+99°C	270	470	1"	280 x 280 x 470	

CHOICE OF THE EXPANSION TANK

The table simplifies the choice of the ELBI expansion tank to be installed in hot water systems. The selection of the tank can be effectuated starting from the system's total capacity or from the plant's power, taking into consideration an average content of 12 litres per 1000 Kcal/h of power and a plant's maximum working pressure of 3 bars

MODELO	PRE-CHARGE PRESSURE	PLANT HEIGHT	TANK ACCEPTABLE VOLUME	TANK ABSORPTION CAPACITY	TOTAL WATER CONTENT IN THE PLANT	HEAT GENERATOR POWER	
	[BAR]	[m]	[LITRES]	[%]	[LITRES]	kcal/h	kW
DE-8	0,5	5	1,3	62	143	11.900	13,84
	1	10	4	50	114	2.400	11,4
DE-18	0,5	5	11,3	63	323	26.900	31,3
	1	10	9	50	257	24.100	28,3
	1,5	15	6,7	37	191	15.900	18,6
DE-24	0,5	5	15,5	65	443	36.900	43
	1	10	12	50	343	28.600	33,26
	1,5	15	9,3	39	266	22.200	28,82

- How to choose a water tank

Pump max delivery capacity [litres/min.]	Δp System working pressure											
	1,5 - 3,0			2,0 - 3,5			2,5 - 4,0			2,5 - 4,0		
	Number of pump starts per hour											
	15	8	5	15	8	5	15	8	5	15	8	5
2	5	8	18	8	18	24	8	18	35	5	8	18
8	18	35	50	24	50	80	80	35	100	24	50	80
10	24	50	60	35	60	100	100	50	150	35	50	100



DL

REPLACEABLE BLADDER MULTI-FUNCTIONAL TANKS

(750- 5000 LITRES)



CE

DL 750 - 2000

DL 3000 - 5000

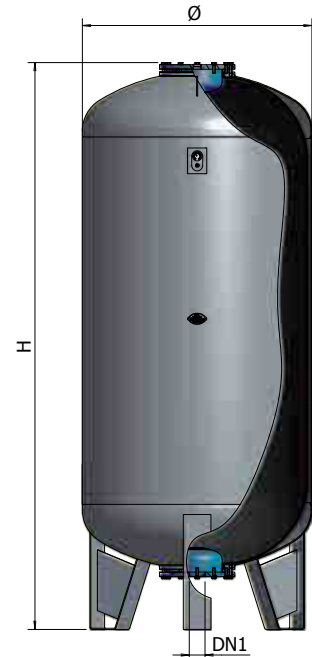

CE certified product



For drinking water



For sanitary hot water



For heating systems



For air conditioning systems



For pressurisation systems

Characteristics:

- Working temperature: -10° / +99°C.
- Solvent-based paint, grey.
- Water and air completely separate.
- Water completely separate from metal parts of the tank.
- Counter-flange with Top-Pro treatment (750 - 1000 litres)
- Glasslined counter-flange (2000 - 5000 litres)

The sizes of DL series bladders trace the inner volume of the tank, enabling the bladder to work without any lengthening and ensuring its almost unlimited duration.

- Pre-charging pressure: 2.5 bar.

Reference standard:

Declaration of conformity to essential requirements outlined by 2014/68/UE Directive.

Models from 750 to 2000 litres with upper tie rod.
The 3000 and 5000 litre models have an upper flange.





The DL series replaceable bladder tanks represent an effective alternative for installation in plants with high water contents which conventionally made us use traditional tanks without any bladders or install series of smaller tanks.

Installation of DL tanks allows therefore considerable cost savings for installation and maintenance.

The DL series is equipped with an exclusively designed bladder which work without mechanical stress even in high pressure conditions or an air cushion leak, thus ensuring an almost unlimited bladder life.

WARRANTY: 2 YEARS

DIMENSIONS

MODEL	CODE		Ppre	Pmax				DN1	NOTES
		LITRES							
DL 750/10 CE	A282L59	750	2,5	10	+99°C	800	1920	G 2"	
DL 1000/10 CE	A282L62	1000	2,5	10	+99°C	800	2370	G 2"	
DL 2000/10 CE	A282L70	2000	2,5	10	+99°C	1100	2690	G 3"	
DL 3000/10 CE	A282L74	3000	2,5	10	+99°C	1250	3100	G 3"	
DL 5000/10 CE	A282L80	5000	2,5	10	+99°C	1550	3315	G 3"	
DL 750/16 CE	A282R59	750	2,5	16	+99°C	800	1920	G 2"	
DL 1000/16 CE	A282R62	1000	2,5	16	+99°C	800	2370	G 2"	
DL 2000/16 CE	A282R70	2000	2,5	16	+99°C	1100	2690	G 3"	
DL 3000/16 CE	A282R74	3000	2,5	16	+99°C	1250	3100	G 3"	

VERSION WITHOUT CE MARK

MODEL	CODE		Ppre	Pmax				DN1	NOTES
		LITRES							
DL 750/16	A280R59 EXP00	750	2,5	16	+99°C	800	1920	G 2"	
DL 1000/16	A280R62 EXP00	1000	2,5	16	+99°C	800	2370	G 2"	
DL 2000/16	A280R70 EXP00	2000	2,5	16	+99°C	1100	2690	G 3"	
DL 3000/16	A280R74 EXP00	3000	2,5	16	+99°C	1250	3100	G 3"	

Bladder accumulator selection chart

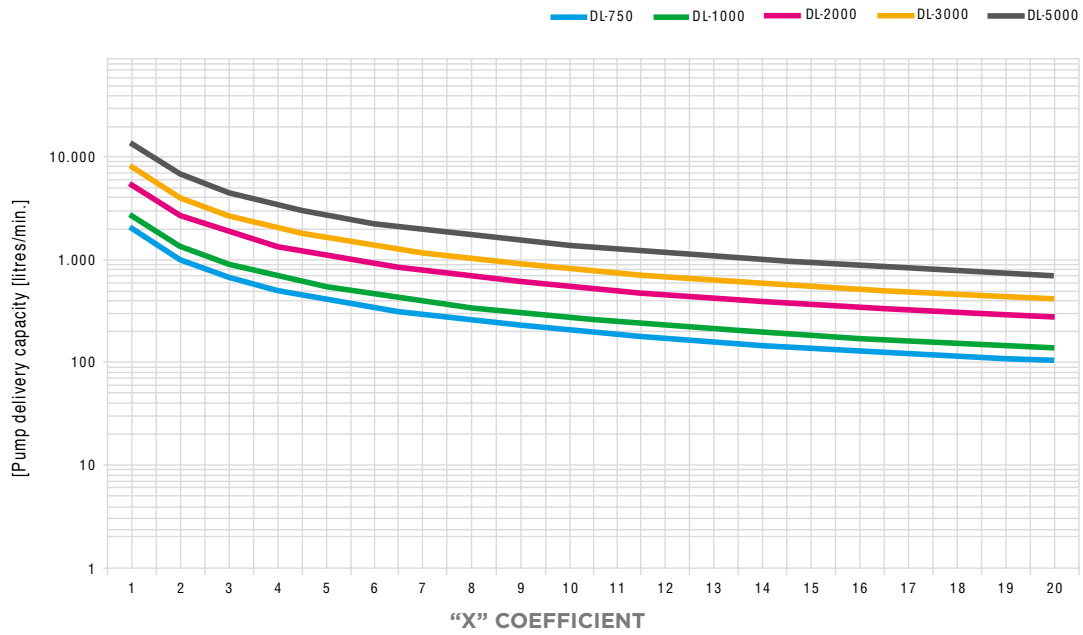

To make sizing easier, a chart has been drawn up to select the most appropriate accumulator according to both working pressure and delivery criteria. Note that the chart is based on the following hypothesis: standard precharge and 15 pump starts per hour (see p. 27 to identify the "X" coefficient).

Pump max delivery capacity [litres/min.]	Δp System working pressure											
	1,5 - 3,0			2,0 - 3,5			2,5 - 4,0			2,5 - 4,0		
	Number of pump starts per hour											
	15	8	5	15	8	5	15	8	5	15	8	5
75	200	300	500	250	500	750	300	750	1000	250	500	750
95	200	500	750	300	750	1000	500	1000	2x750	300	500	1000
115	250	500	750	500	750	1000	500	1000	2x750	300	750	1000
150	300	750	1000	500	1000	2x750	750	2x750	2000	500	1000	2x750
200	500	1000	2x750	750	2x750	2000	1000	2000	3000	750	2x750	2000
300	750	2x750	2000	1000	2000	3000	2x750	3000	2x2000	1000	2x750	3000
500	2x750	2000	3000	2000	3000	5000	3000	5000	5000+3000	2x750	3000	2x2000
800	2000	3000	5000	3000	5000	4x2000	2x2000	5000+3000	2x5000	2000	2x2000	5000+2000
1000	2000	2000	2x3000	2x2000	2x3000	2x5000	5000	2x5000	3x5000	3000	5000	5000+3000



MICRON

WATER HAMMER ARRESTOR MINI-TANK

(160ML)

MICRON

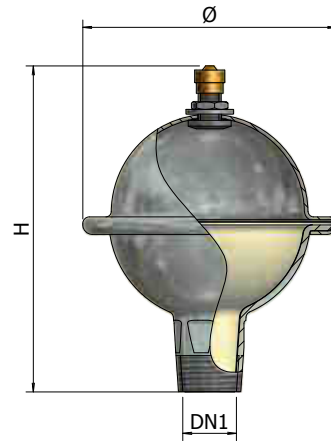

EXAMPLES OF INSTALLATION

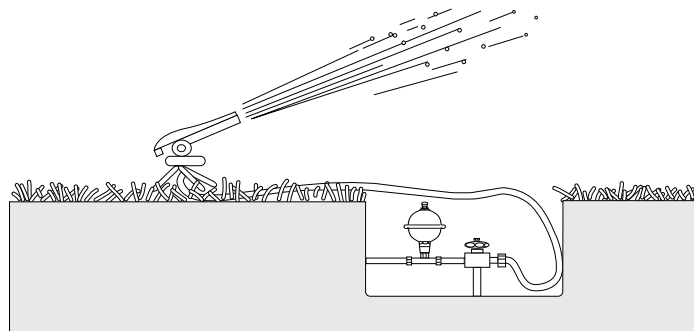
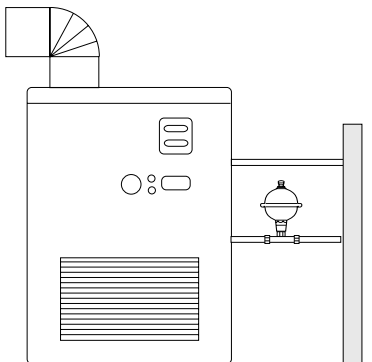
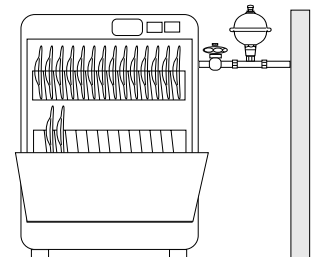
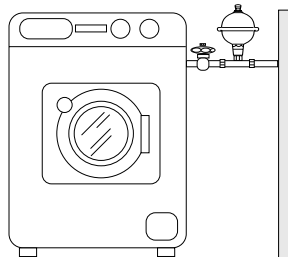
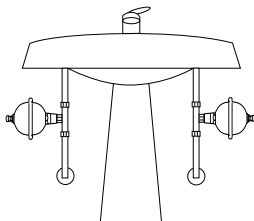





 Water hammer arrestor

 For drinking water

 For pressurisation systems

The Micron mini-tank is designed to absorb sudden overpressure caused by water hammer in pressurised hydraulic systems. The use of a MICRON mini-tank eliminates noise and vibrations caused by these phenomena, thus increasing the life of the system.

WARRANTY: 2 YEARS

MODEL	CODE	 Ppre	Pmax	 max	 mm	 mm	DN1	 mm	NOTES
		LITRES	bar	bar	max	mm	mm		
MICRON	12A0000	0,16	3,5	10	+99°C	88	121	1/2"	270 x 270 x 180

WATER HAMMER ARRESTOR: TECHNICAL FEATURES

Water hammer (overpressure shock) is caused by the sudden closing of a valve or similar device in a hydraulic system. The sudden closure causes a sonic pressure wave to travel backward through the pipe system. As the pressure wave hits obstructions in the system, additional pressure waves are reflected back in the opposite direction. These pressure waves will cause loud noises within the system and can lead to physical damage and shorten system life if left unchecked. To overcome this problem the system must be equipped with a hydraulic shock absorber able to absorb the pressure wave through the use of an air cushion. The Micron hammer arrestor is the perfect device for this purpose.

Installation examples of pressure tanks used as shock hammer absorbers:

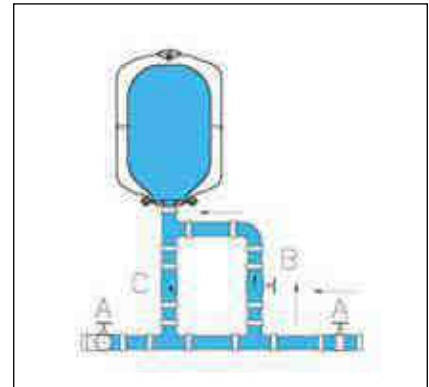
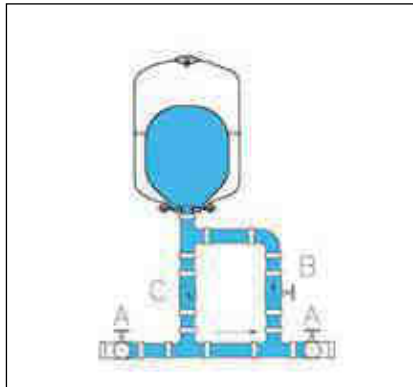
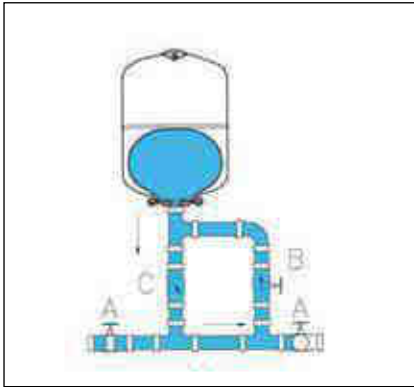

Constant pressure

The "A" valves are open and the water rate of flow inside the pipeline is constant. During this phase, the vessel gradually fills up until the pressure becomes identical to the system's.

Case No. 1

Whenever the "A" valve upstream suddenly shuts down, the water column inside the pipeline follows its course and, in order to avoid a pressure drop at the valve outlet, i.e. a narrowing of the pipeline, the "C" check valve opens to release part of the stored water.

Case No. 2

Whenever the "A" valve downstream suddenly shuts down, the water column inside the pipeline preceding the valve creates a pressure wave. This wave reverberates throughout the pipeline; in this case, water can only pass through the "B" narrowing valve, which cushions the water hammer, gradually filling up the vessel in the process.



SANY

REPLACEABLE BLADDER SANITARY TANKS, FOR SMALL SPACES

(0,5 - 6 LITRES)

SANY

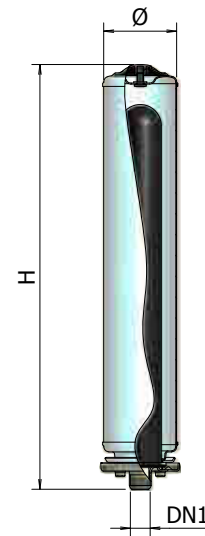

For drinking water



For pressurisation systems



Water hammer arrestor



For sanitary hot water

Characteristics:

- Min./max. working temperature: -10° / +99°C;
- Long lasting epoxy powder paint, white;
- Replaceable bladder in butyl rubber;
- Plastic screen flange protection;
- Exempt from CE marking.

Replaceable butyl bladder slim type tanks

ELBI Slim type Tanks serve the double purpose of Shock Absorber and Domestic Hot Water storage vessel in wall hung and floor standing boilers.

The SANY product line has been designed by ELBI to respond to OEM's and contractors' demand for plumbing cushions that can be fitted in small and narrow spaces. The product design and appliance-finish paint render these vessels suitable for use in open/visible spaces of the house as well.

WARRANTY: 2 YEARS

DIMENSIONS

MODEL	CODE	LITRES	Ppre bar	Pmax bar	max °C	Ø mm	H mm	DN1 mm	NOTES
SANY-S 0,5	A250L03	0,5	3	10	+99°C	90	145	3/4" GAS	
SANY-S 1	A250L05	1	3	10	+99°C	90	220	3/4" GAS	
SANY-S 2	A250L07	2	3	10	+99°C	90	360	3/4" GAS	
SANY-S 3	A250L09	3	3	10	+99°C	90	510	3/4" GAS	
SANY-S 4	A250L10	4	3	10	+99°C	90	650	3/4" GAS	
SANY-L 3	A260L09	3	3	10	+99°C	120	300	1/2" GAS	
SANY-L 6	A260L12	6	3	10	+99°C	120	500	1/2" GAS	





EXPANSION TANKS FOR HEATING



EXPANSION TANKS FOR HEATING

EXPANSION TANKS ARE DEVICES DESIGNED TO ABSORB THE VOLUME CHANGE OF WATER OR SOME OTHER LIQUIDS, THUS ALLOWING THE CORRECT OPERATION OF A HEATING PLANT DURING ALL ITS OPERATING PHASES.

Elbi produces closed expansion tanks composed of a tank in sheet steel and a bladder in synthetic material which separates the heating circuit from a chamber previously charged with air.

Expansion tanks with bladder are made of quality sheet steel in compliance with EN standards and welded according to strict qualitative standards; they are produced on automated lines, welded with procedures and certified weld materials, equipped with bladders in rubber suitable to resist up to 110°C; they are pre-charged with pressure of 0.5 - 1.0 - 1.5 - 2 - 2.5 - 3 bar according to the static height of the water column.

All models are subject to a hydraulic test with a pressure of 1.5 times higher than the design pressure.

Versions manufactured according to the most important European standards in force are available and are supplied with a Declaration of Conformity pursuant to the essential safety requirements outlined by 2014/68/UE Directive.

ELBI BLADDERS

Designed by the Elbi technical office, bladders are tested by the quality control service once the manufacturing cycle is completed.



EXPANSION TANKS FOR HEATING

46. AC-2 / ER-CE:

FIXED BLADDER EXPANSION TANKS FOR HEATING (2 - 24 LITRES)

48. ERCE:

FIXED BLADDER EXPANSION TANKS FOR HEATING (35 - 500 LITRES)

50. ERP:

FIXED-BLADDER FLAT EXPANSION TANKS FOR BURNERS (6 - 24 LITRES)

52. SIZING AN EXPANSION TANK (RACCOLTA "R", ED. 2009)

55. UNIVERSAL DIAGRAM FOR SELECTING AN EXPANSION TANK





AC-2 / ER-CE

FIXED BLADDER EXPANSION TANKS FOR HEATING

(2 - 24 LITRES)



AC - 2

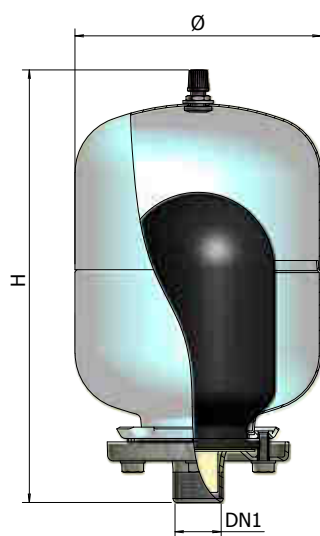

ER 5 - 24

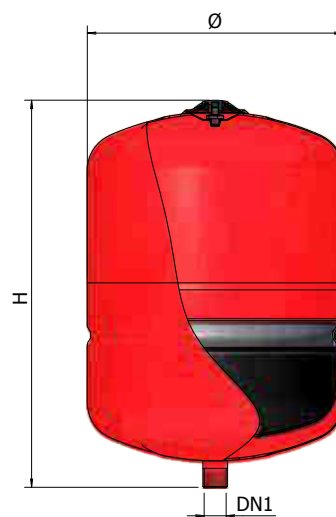

CE certified product



For non-drinking water



For heating systems



For air conditioning systems

Characteristics:

- Working temperature: -10° / +99°C
- Long lasting epoxy powder paint, red. (Model AC-2: white)
- Fixed bladder in SBR rubber (Model AC-2: replaceable butyl bladder)
- Wall fixing bracket on request (see page 229)

Reference standard

- Declaration of conformity to essential safety requirements outlined by 2014/68/UE Directive. Models AC-2/ER5 are exempt from CE marking.

WARRANTY: 2 YEARS

DIMENSIONS

MODEL	CODE		Ppre	Pmax				DN1		NOTES
		LITRES	bar	bar	max	mm	mm	mm		
AC-2 *	A012J07	2	2,5	8	+99°C	130	225	3/4"	150 x 150 x 240	
ER 5 *	A102L11	5	1,5	8	+99°C	205	215	3/4"	210 x 210 x 250	
ER 8 CE	A102L16	8	1,5	8	+99°C	205	280	3/4"	210 x 210 x 320	
ER 12 CE	A102L20	12	1,5	8	+99°C	270	300	3/4"	280 x 280 x 310	
ER 18 CE	A102L24	18	1,5	8	+99°C	270	410	3/4"	280 x 280 x 450	
ER 24 CE	A102L27	24	1,5	8	+99°C	320	330	3/4"	330 x 330 x 375	

* Exempt from CE marking

CHOICE OF THE EXPANSION TANK

The table simplifies the choice of the ELBI expansion tank to be installed in hot water systems. The selection of the tank can be effectuated starting from the system's total capacity or from the plant's power, taking into consideration an average content of 12 litres per 1000 Kcal/h of power and a plant's maximum working pressure of 3 bars

MODEL	PRE-CHARGE PRESSURE [BAR]	PLANT HEIGHT [m]	TANK ACCEPTABLE VOLUME [litri]	TANK ABSORPTION CAPACITY [%]	$\Delta T = (90 - 14)^\circ\text{C}$ Δ expansion coefficient 0,035		
					TOTAL WATER CONTENT IN THE PLANT [litres]	HEAT GENERATOR POWER	
						kcal/h	kW
AC-2	0,5	5	1,3	62,5	36	3.000	3,49
	1	10	1	50	29	2.400	2,79
ER 5	0,5	5	3,1	62	89	7.400	8,6
	1	10	2,5	50	71	5.900	6,86
ER 8 CE	0,5	5	5	62	143	11.900	13,84
	1	10	4	50	114	9.500	11,4
ER 12 CE	0,5	5	7,5	63	214	17.800	20,7
	1	10	6	50	171	14.250	16,57
ER 18 CE	0,5	5	11,3	63	323	26.900	31,3
	1	10	9	50	257	24.100	28,2
	1,5	15	6,7	37	191	15.900	18,5
ER 24 CE	0,5	5	15,5	65	443	36.900	43
	1	10	12	50	343	28.600	33,26
	1,5	15	9,3	39	266	22.200	25,82



ERCE

FIXED BLADDER EXPANSION TANKS FOR HEATING

(35 - 500 LITRES)



ERCE 35 - 50

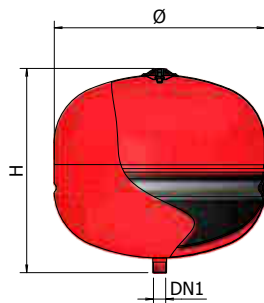

ERCE 35/P - 50/P

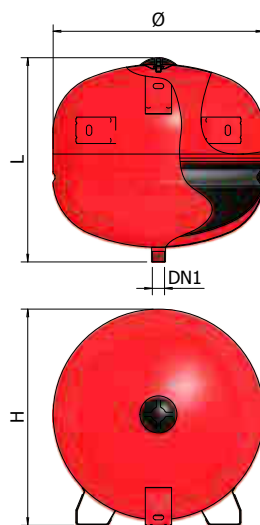

ERCE 80 - 500

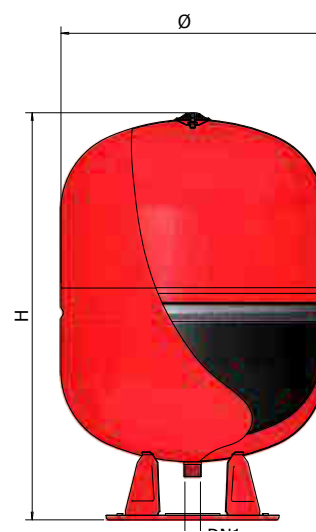

CE certified product



For non-drinking water



For heating systems



For air conditioning systems

Characteristics:

- Working temperature: -10° / $+99^{\circ}$ C
- Long lasting epoxy powder paint, red.
- Fixed bladder in SBR rubber
(Model AC-2: replaceable butyl bladder)
- Wall fixing bracket on request (see page 229)

Reference standard

- Declaration of conformity to essential requirements outlined by 2014/68/UE Directive.

WARRANTY: 2 YEARS

DIMENSIONS

MODEL	CODE		Ppre	Pmax					DN1		NOTES
		LITRES	bar	bar	max	mm	mm	mm		mm	
ERCE 35	A102L31	35	1,5	10	+99°C	400	395	-	3/4"	410 x 410 x 410	
ERCE 35/P*	A122L31	35	1,5	10	+99°C	400	415	395 (LENGTH)	3/4"	410 x 410 x 410	
ERCE 50	A102L34	50	1,5	10	+99°C	400	500	-	3/4"	410 x 410 x 535	
ERCE 50/P*	A122L34	50	1,5	10	+99°C	400	415	500 (LENGTH)	3/4"	410 x 410 x 535	
ERCE 80	A112L37	80	1,5	10	+99°C	400	820	-	3/4"	410 x 410 x 860	
ERCE 100	A112L38	100	1,5	10	+99°C	500	735	-	3/4"	510 x 510 x 830	
ERCE 150	A112L43	150	1,5	10	+99°C	500	935	-	3/4"	510 x 510 x 1040	
ERCE 200	A112L47	200	1,5	10	+99°C	600	1020	-	1"	610 x 610 x 1110	
ERCE 250	A112L49	250	1,5	10	+99°C	650	1160	-	1"	660 x 660 x 1210	
ERCE 300	A112L51	300	1,5	10	+99°C	650	1210	-	1"	660 x 660 x 1290	
ERCE 500	A112L55	500	1,5	10	+99°C	775	1350	-	1"	785 x 785 x 1440	

1MPa = 10 bar 1MPa = 10 bar

*Version with feet for wall fixing

CHOICE OF THE EXPANSION TANK

The table simplifies the choice of the ELBI expansion tank to be installed in hot water systems. The selection of the tank can be effectuated starting from the system's total capacity or from the plant's power, taking into consideration an average content of 12 litres per 1000 Kcal/h of power.

MODEL	PRE-CHARGE PRESSURE	MAXIMUM WORKING PRESSURE OF SYSTEM	PLANT HEIGHT	TANK ACCEPTABLE VOLUME	TANK ABSORPTION CAPACITY	$\Delta T = (90 - 14)^\circ\text{C}$ Δ expansion coefficient 0.035		
						TOTAL WATER CONTENT IN THE PLANT	HEAT GENERATOR POWER	
						[litres]	kcal/h	kW
ER CE 35	[BAR]	[BAR]	[m]	[litres]	[%]	[litres]		
	1		10	17,6	50	503	41.900	48,72093
	1,5	3	15	13,1	37	374	31.200	36,27907
ER CE 50	2		20	8,8	25	251	20.900	24,30233
	1		10	25	50	714	59.500	69,18605
	1,5	3	15	18,8	38	537	71.400	52,03488
ER CE 80	2		20	12,5	25	357	29.750	34,59302
	1		5	40	50	1.143	95.250	110,7558
	1,5	3	10	30	38	857	71.400	83,02326
ER CE 100	2		20	20	25	571	47.600	55,34884
	1		10	50	50	1.428	119.000	138,3721
	1,5	5	15	38	38	1.086	90.500	105,2326
ER CE 150	2		20	25	25	714	59.500	69,18605
	0,5		5	100	67	2.857	238.000	276,7442
	1	5	10	87	58	2.486	207.000	240,6977
ER CE 200	1,5		15	75	50	2.143	178.600	207,6744
	1		5	133	67	3.800	317.000	368,6047
	1,5		15	116	58	3.314	276.000	320,9302
	2	5	20	100	50	2.857	238.000	276,7442
	2,5		25	83	42	2.371	197.600	229,7674
ER CE 250	3		30	66	33	1.886	157.200	182,7907
	1		5	178	71	5.086	423.800	492,7907
	1,5		15	160	64	4.571	380.900	442,907
	2	5	20	143	57	4.086	340.500	395,9302
	2,5		25	125	50	3.571	297.600	346,0465
ER CE 300	3		30	107	43	3.057	254.800	296,2791
	1		5	214	71	6.114	509.500	592,4419
	1,5		15	193	64	5.514	459.500	534,3023
	2	6	20	171	57	4.886	407.000	473,2558
	2,5		25	150	50	4.286	357.200	415,3488
ER CE 500	3		30	128	43	3.657	304.800	354,4186
	1,5		5	321	64	9.171	764.300	888,7209
	2		15	285	57	8.143	678.600	789,0698
	2,5	6	20	250	50	7.143	595.300	692,2093
	3		25	215	43	6.143	512.000	595,3488
	3,5		30	178	36	5.086	427.000	496,5116



ERP

FIXED-BLADDER FLAT EXPANSION TANKS, FOR BURNERS

(6 - 24 LITRES)

ERP Q

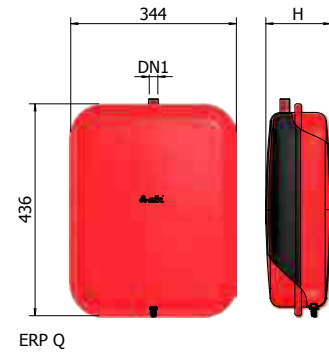

ERP 320

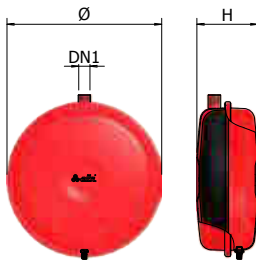

ERP 385

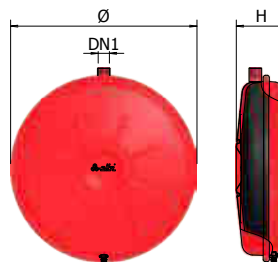

ERP RET

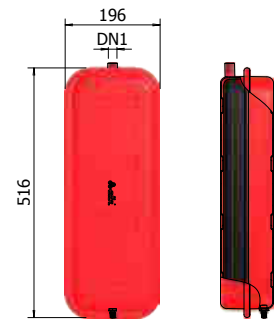

For non-drinking water



For heating systems

Characteristics:

- Working temperature: -10° / +90°C.
- Long lasting epoxy powder paint, red.
- SBR rubber bladder with characteristics to guarantee the best performance and long duration.

ERP 320 and ERP 385:
Articles supplied in packs of 4 pieces.

ERP RET
Articles supplied in packs of 2 pieces.

WARRANTY: 2 YEARS

DIMENSIONS

MODEL	CODE		Ppre	Pmax					DN1	NOTES
		LITRES	bar	bar	max	mm	mm	mm		
ERP 320/6	1120106	6	1	3	+90°C	320	94	-	3/4"	
ERP 320/8	1120203	8	1	3	+90°C	320	121	-	3/4"	
ERP 320/10	1120301	10	1	3	+90°C	320	131	-	3/4"	
ERP 320/12	1120408	12	1	3	+90°C	320	165	-	3/4"	
ERP 385/7	1121101	7	1	3	+90°C	385	83	-	3/4"	
ERP 385/8	1121209	8	1	3	+90°C	385	98	-	3/4"	
ERP 385/10	1121306	10	1	3	+90°C	385	108	-	3/4"	
ERP 385/12	1121403	12	1	3	+90°C	385	139	-	3/4"	
ERP 385/14	1121501	14	1	3	+90°C	385	146	-	3/4"	
ERP 416/8	1135007	8	1	3	+90°C	416	75	-	3/8"	
ERP RET/6	1140601	6	1	3	+90°C	-	-	516 x 196 x 95	3/4"	
ERP RET/8	1140701	8	1	3	+90°C	-	-	516 x 196 x 110	3/4"	
ERP RET/10	1140901	10	1	3	+90°C	-	-	516 x 196 x 124	3/4"	
ERP RET/12	1141001	12	1	3	+90°C	-	-	516 x 196 x 152	3/4"	
ERP-Q/7	1150007	7	1	3	+90°C	-	-	436 x 344 x 77	3/8"	
ERP-Q/10	1150009	10	1	3	+90°C	-	-	436 x 344 x 97	1/2"	
ERP-Q/12	1150010	12	1	3	+90°C	-	-	436 x 344 x 117	1/2"	
ERP-Q/14	1150011	14	1	3	+90°C	-	-	436 x 344 x 132	1/2"	
ERP-Q/16	1150013	16	1	3	+90°C	-	-	436 x 344 x 147	1/2"	
ERP-Q/18	1150014	18	1	3	+90°C	-	-	436 x 344 x 155	1/2"	
ERP-Q/20	1150015	20	1	3	+90°C	-	-	436 x 344 x 162	1/2"	
ERP-Q/24	1150016	24	1	3	+90°C	-	-	436 x 344 x 177	1/2"	

CHOICE OF THE EXPANSION TANK

The table simplifies the choice of the ELBI expansion tank to be installed in hot water systems. The selection of the tank can be effectuated starting from the system's total capacity or from the plant's power, taking into consideration an average content of 8 litres per 1000 Kcal/h of power, a precharge pressure of 1 bar and a plant's maximum working pressure of 3 bars.

$$\Delta T = (90 - 14)^\circ\text{C}$$

$$\Delta \text{ expansion coefficient } 0.035$$

MODEL	PRE-CHARGE PRESSURE	PLANT HEIGHT	TANK ACCEPTABLE VOLUME	TANK ABSORPTION CAPACITY	TOTAL WATER CONTENT IN THE PLANT	HEAT GENERATOR POWER	
	[BAR]	[m]	[litres]	[%]	[litres]	kcal/h	kW
ERP 320/6	1,0	10	3,0	50	86	10.700	12,44
ERP 320/8	1,0	10	4,0	50	114	14.300	16,63
ERP 320/10	1,0	10	5,0	50	143	17.900	20,80
ERP 320/12	1,0	10	6,0	50	172	21.500	25,00
ERP 385/7	1,0	10	3,5	50	100	12.500	14,53
ERP 385/8	1,0	10	4,0	50	114	14.300	16,63
ERP 385/10	1,0	10	5,0	50	143	17.900	20,81
ERP 385/12	1,0	10	6,0	50	172	21.500	25,00
ERP 385/14	1,0	10	7,0	50	200	25.000	29,10
ERP 416/8	1,0	10	4,0	50	114	14.300	16,63
ERP RET 6	1,0	10	3,0	50	86	10.700	12,44
ERP RET 8	1,0	10	4,0	50	114	14.300	16,63
ERP RET 10	1,0	10	5,0	50	143	17.900	20,81
ERP RET 12	1,0	10	6,0	50	172	21.500	25,00
ERP Q 7	1,0	10	3,5	50	100	12.500	14,53
ERP Q 10	1,0	10	5,0	50	143	17.900	20,81
ERP Q 12	1,0	10	6,0	50	172	21.500	25,00
ERP Q 14	1,0	10	7,0	50	200	25.000	29,10
ERP Q 16	1,0	10	8,0	50	228	28.500	33,14
ERP Q 18	1,0	10	9,0	50	258	32.200	37,44
ERP Q 20	1,0	10	10,0	50	286	35.800	41,63
ERP Q 24	1,0	10	12,0	50	343	42.900	49,88

MPa = 10 bar
 Max press. 3 bar
 t max 90°C
 t min 10°C

SIZING OF A PRE-PRESSURISED EXPANSION TANK WITH BLADDER FOR HEATING SYSTEMS ("RACCOLTA_R", EDITION 2009)

The closed expansion tank volume must be sized in relation to the expansion volume of the water in the system.
The expansion volume (V_e) is the maximum variation of the water volume which can be in the system:

$$V_e = V_a \cdot \frac{n}{100}$$

Where:

V_a = total volume of the system [litres]

$n = 0.31 + 3.9 \cdot 10^{-4} \cdot t_m^2$

t_m = maximum permitted temperature in °C referring to safety device activation

The nominal volume V_n of the closed expansion tank with a bladder is calculated using the following formula:

$$V_n \geq \frac{V_e}{1 - \frac{P_1}{P_2}}$$

Where:

P_1 = absolute pressure in bar to which the gas cushion pre-charge; pressure which should not be lower than the hydro-static pressure of the point in which the chamber is installed (or the recovery pressure of the filling unit). This absolute initial pressure value cannot be lower than 1.5 bar.

P_2 = absolute calibration pressure of the safety valve, in bar, decreased by a quantity corresponding to the drop in the existing height difference between the expansion tank and the safety valve, if the latter is placed lower or increased if placed higher.

TABLES FOR THE TANK SELECTION

**TAB.
1**

SPECIFIC VOLUME OF THE WATER AT VARIOUS TEMPERATURES

T °C	U litres/Kg	T °C	U litres/Kg	T °C	U litres/Kg	T °C	U litres/Kg
-10	1,00186	16	1,00103	36	1,00632	80	1,0290
-5	1,00070	18	1,00138	38	1,00706	85	1,0324
0	1,00013	20	1,00177	40	1,0078	90	1,0359
2	1,00003	22	1,00221	45	1,0099	95	1,0396
4	1,00000	24	1,00268	50	1,0121	100	1,0434
6	1,00003	26	1,00320	55	1,0145	10	1,0515
8	1,00012	28	1,00375	60	1,0171	120	1,0600
10	1,00027	30	1,00435	65	1,0198	130	1,0795
12	1,00048	32	1,00497	70	1,0227	140	1,0795
14	1,00073	34	1,00563	75	1,0258	150	1,0903

**TAB.
2A**

WORKING PRESSURE

WORKING PRESSURE (BAR)

	1	1,5	2	2,5	3	3,5	4	4,5	5
1,5	0,2								
2	0,333	0,167							
2,5	0,429	0,286	0,143						
3	0,5	0,375	0,25	0,125					
3,5	0,556	0,444	0,333	0,222	0,111				
4	0,6	0,5	0,400	0,3	0,2	0,1			
4,5	0,636	0,545	0,455	0,364	0,273	0,182	0,091		
5	0,667	0,583	0,5	0,417	0,333	0,25	0,167	0,083	
5,5	0,692	0,615	0,538	0,462	0,385	0,308	0,231	0,154	0,07
6	0,714	0,643	0,571	0,5	0,429	0,357	0,286	0,21	0,14
6,5	0,733	0,667	0,60	0,533	0,467	0,4	0,333	0,26	0,2
7	0,75	0,688	0,625	0,563	0,5	0,438	0,375	0,31	0,25
7,5	0,765	0,706	0,647	0,588	0,529	0,471	0,412	0,35	0,29
8	0,778	0,722	0,667	0,611	0,556	0,5	0,444	0,38	0,33
8,5	0,789	0,737	0,684	0,632	0,579	0,526	0,474	0,42	0,36
9	0,8	0,75	0,7	0,65	0,6	0,55	0,5	0,45	0,4
9,5	0,81	0,762	0,714	0,667	0,619	0,571	0,524	0,47	0,43
10	0,818	0,773	0,727	0,682	0,636	0,591	0,545	0,5	0,45

TAB.
2B

WORKING PRESSURE	WORKING PRESSURE (BAR)								
	5,5	6	6,5	7	7,5	8	8,5	9	9,5
6	0,07								
6,5	0,13	0,06							
7	0,18	0,12	0,06						
7,5	0,23	0,17	0,11	0,06					
8	0,28	0,22	0,16	0,11	0,06				
8,5	0,31	0,26	0,21	0,16	0,1	0,05			
9	0,35	0,3	0,25	0,21	0,15	0,1	0,05		
9,5	0,38	0,33	0,28	0,24	0,19	0,14	0,01	0,05	
10	0,41	0,36	0,32	0,27	0,23	0,18	0,14	0,09	0,09

TAB.
2

COEFFICIENTS OF THE WATER EXPANSION IN % (WITH OR WITHOUT THE ADDITION OF ANTI-FREEZE GLYCOL)

T °C	WATER ONLY	ANTI-FREEZE				
		10%	20%	30%	40%	50%
10	0,04	0,32	0,64	0,96	1,28	1,60
15	0,11	0,43	0,75	1,07	1,39	1,71
20	0,18	0,50	0,82	1,14	1,46	1,78
25	0,31	0,63	0,95	1,27	1,59	1,91
30	0,44	0,76	1,08	1,40	1,72	2,04
35	0,62	0,94	1,26	1,58	1,90	2,22
40	0,79	1,11	1,43	1,75	2,07	2,39
45	1,00	1,32	1,64	1,96	2,28	2,60
50	1,21	1,53	1,85	2,17	2,49	2,81
55	1,46	1,78	2,10	2,42	2,74	3,06
60	1,71	2,03	2,35	2,67	2,99	3,31
65	2,01	2,33	2,65	2,97	3,29	3,61
70	2,28	2,60	2,92	3,24	3,56	3,88
75	2,59	2,91	3,23	3,55	3,87	4,19
80	2,90	3,22	3,54	3,86	4,18	4,50
85	3,21	3,53	3,85	4,17	4,49	4,81
90	3,59	3,91	4,23	4,55	4,87	5,19
95	3,96	4,29	4,61	4,93	5,25	5,57
100	4,35	4,67	4,99	5,31	5,63	5,95

TAB. 3

WATER VOLUME

T °C	DENSITY KG/L.
10	0,99975
15	0,99915
20	0,99820
25	0,99711
30	0,99576
35	0,99421
40	0,99224
45	0,99025
50	0,98807
55	0,98573
60	0,98324
65	0,98059
70	0,98781
75	0,97849
80	0,97183
85	0,96865
90	0,96534
95	0,96192
100	0,95838

EXAMPLE OF INSTALLATION

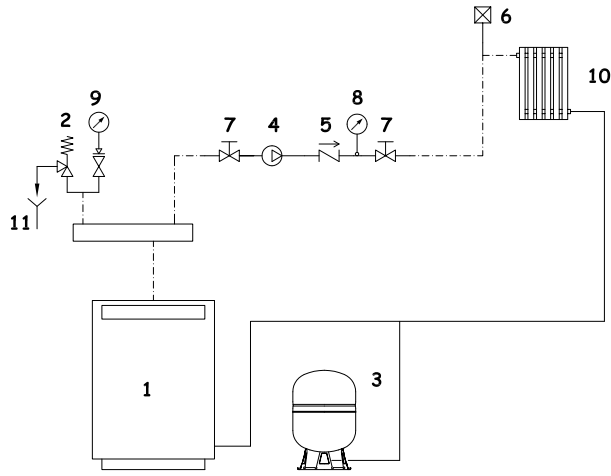

KEYWORD

- 1 - Heat generator
- 2 - Safety valve
- 3 - ERCE series expansion tank
- 4 - Boiler circuit pump
- 5 - Check valve
- 6 - Venting valve
- 7 - Shut-off valve
- 8 - Thermometer
- 9 - Gauge
- 10 - Radiator
- 11 - Drain

TAB. 4

TYPE OF TANK ACCORDING TO THE PLANT'S WATER VOLUME (M3) AND THE MAX. WORKING TEMPERATURE (°C)

DL	Volume m ³				EXPANSION (litres)
	70°C	80°C	90°C	100°C	
300	11	9	7	6	250
500	19	15	12	10	430
750	28	22	18	15	640
1000	38	30	24	20	850
2000	76	59	48	39	1.700
3000	114	89	72	59	2.550
5000	190	149	118	99	4.250

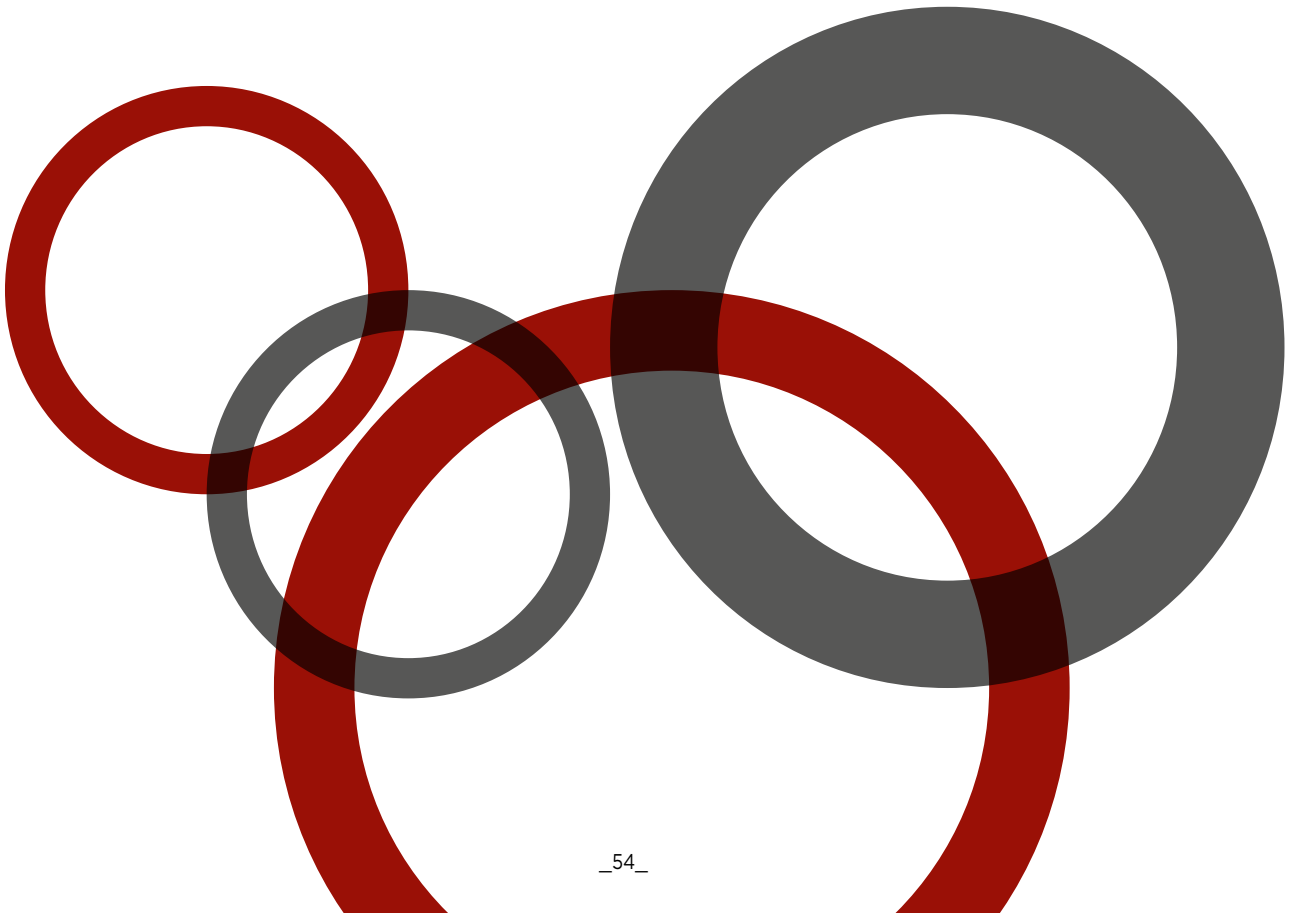

ELBI expansion tanks

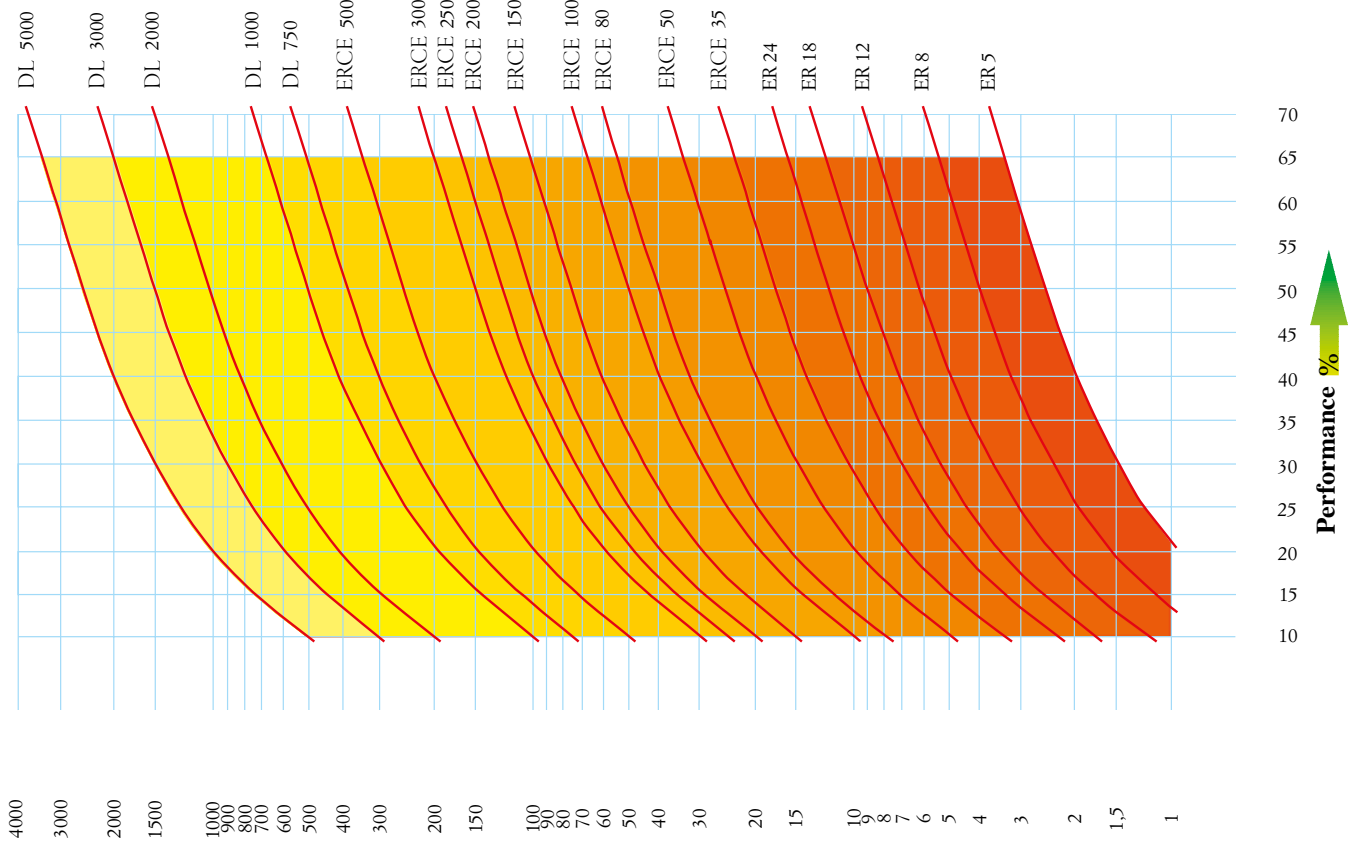

Expansion volume in litres

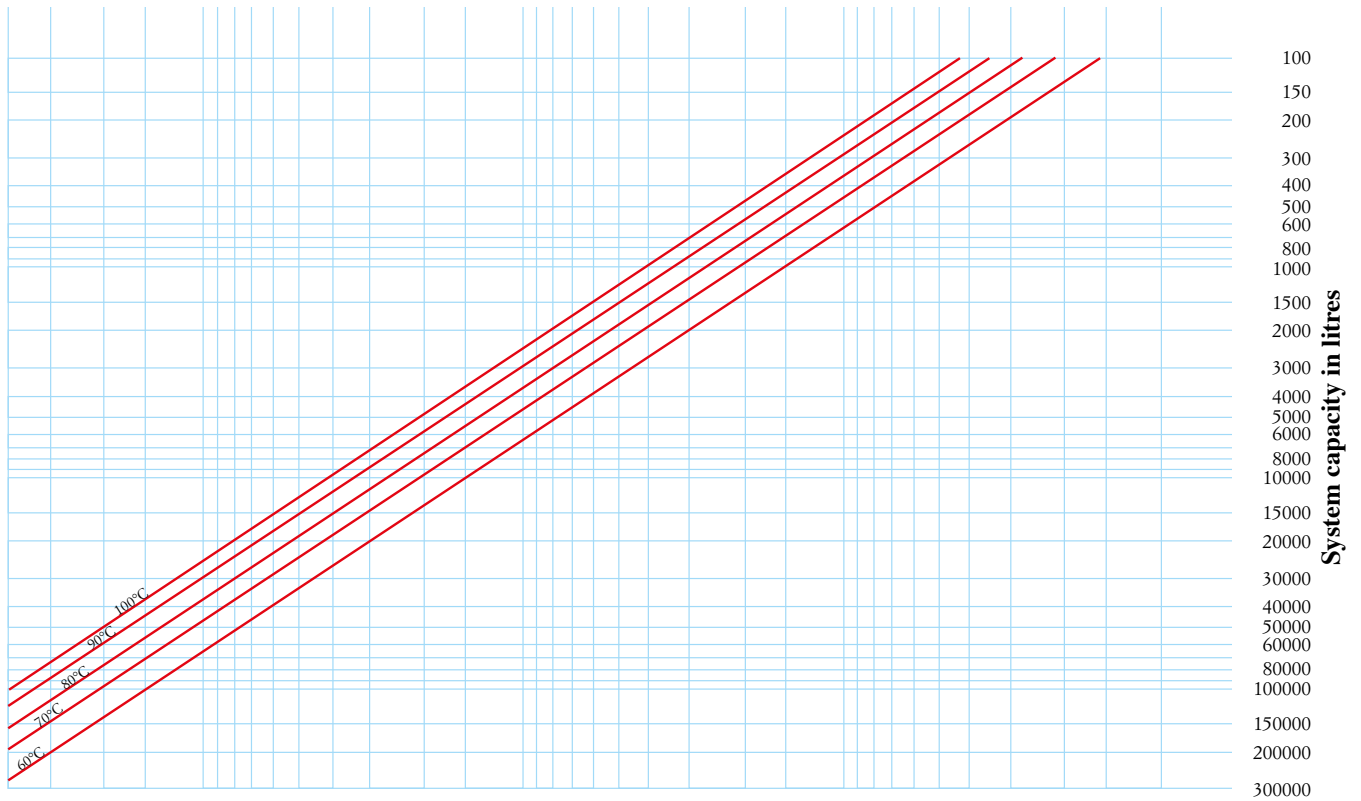

Pre-charge pressure (bar)

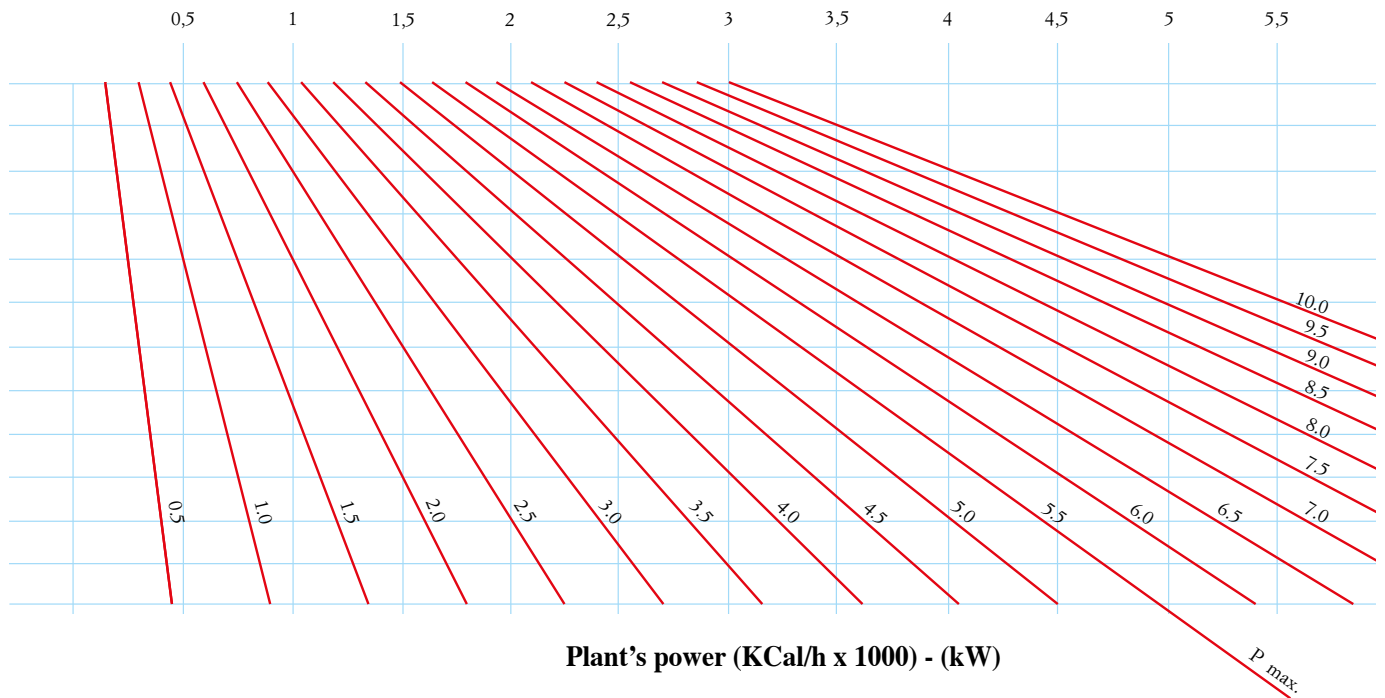

Kcal/h x 1000	kW
10	11,628
15	17,442
20	23,256
30	34,884
40	46,512
50	58,140
60	69,767
70	81,395
80	93,023
90	104,651
100	116,279
150	174,419
200	232,558
300	348,837
400	465,116
500	581,395
600	697,674
700	813,953
800	930,233
900	1046,512
1000	1162,791
1500	1744,186
2000	2325,581
3000	3488,372
4000	4651,163
5000	5813,953
6000	6976,744
7000	8139,535
8000	9302,326
9000	10465,116
10000	11627,907
15000	17441,860
20000	23255,814
30000	34883,721
40000	46511,628
50000	58139,535
60000	69767,442
70000	81395,349
80000	93023,256
90000	104651,163
100000	116279,070

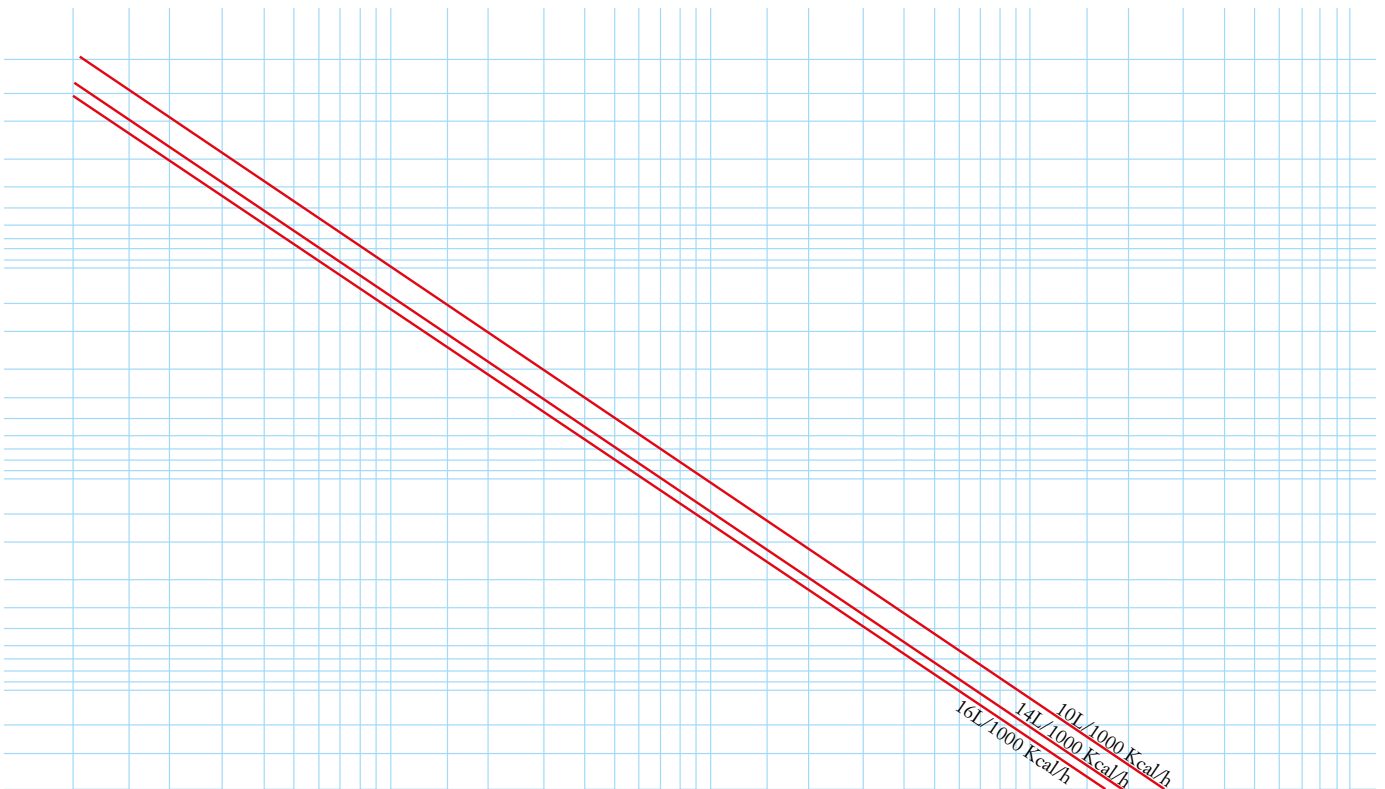

16L/1000kcal/h : plant with radiators
 14L/1000kcal/h : plant with convectors (or radiating panels with steel tubes)
 10L/1000kcal/h : plant with radiating panels with copper tubes

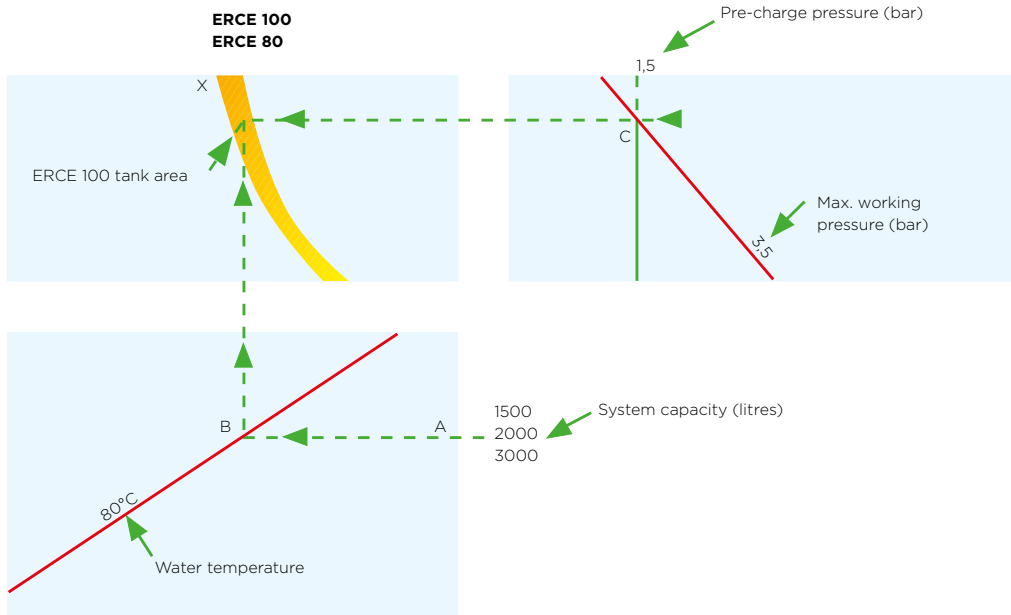

Determination of the expansion tank according to the plant's water content

The initial data used to determine the expansion tank's capacity are the following ones, namely:

- plant's static pressure or precharge pressure (absolute pressure);
- maximum working pressure of the plant (absolute pressure);
- water mean temperature;
- plant's capacity.

As you know already the plant's capacity, draw a horizontal line until intersecting the water mean temperature line "A-B". From the point "B", draw a vertical line up to the above graph. Since you know already the precharge pressure and the plant's maximum pressure, it is necessary to find the intersection point of the two right lines "C" and, starting from this one, draw a horizontal line until reaching the graph on the side. In the intersection point of these two right lines "X" you find the expansion tank necessary for the plant.

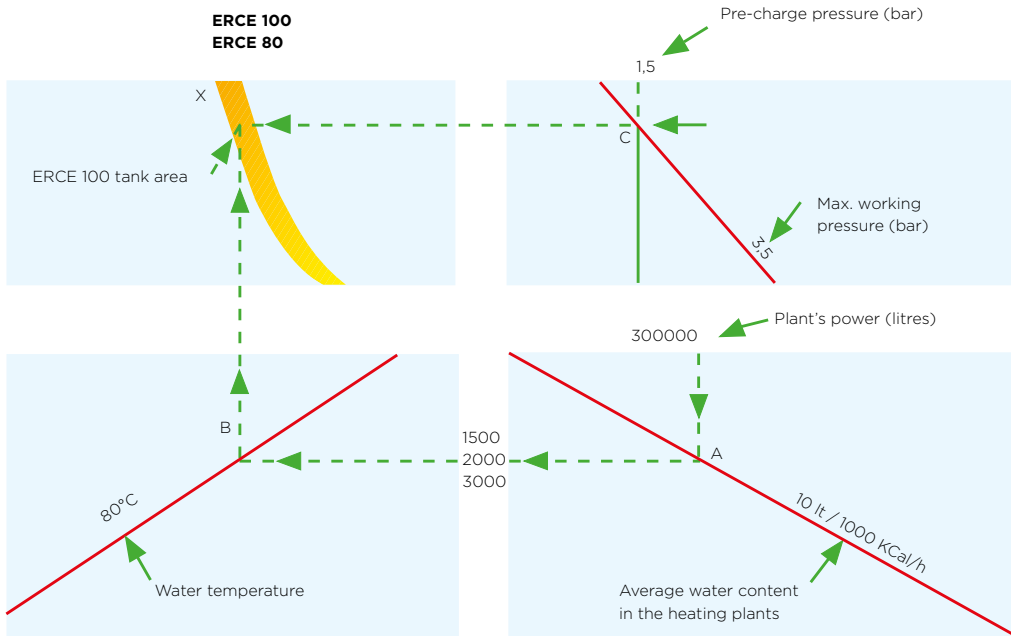

Determination of the expansion tank according to the plant's power

The initial data used to determine the expansion tank's capacity are the following ones, namely:

- plant's static pressure or precharge pressure (absolute pressure);
- plant's static pressure or precharge pressure (absolute pressure);
- maximum working pressure of the plant (absolute pressure);
- water mean temperature;
- plant's power.

Since you know already the power, draw a vertical line until intersecting the right line relevant to the mean water content of the plant "A". Starting from the point "A", draw a horizontal line until intersecting the water mean temperature line "AB". From the point "B", draw a vertical line up to the above graph. Since you know already the precharge pressure and the plant's maximum pressure, it is necessary to find the intersection point of the two right lines "C" and, starting from this one, draw a horizontal line until reaching the graph on the side. In the intersection point of these two right lines "X" you find the expansion tank necessary for the plant.



TANKS FOR SOLAR SYSTEMS

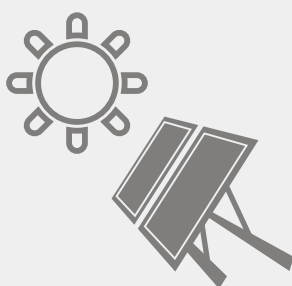

TANKS FOR SOLAR SYSTEMS

THE TANKS FOR SOLAR SYSTEMS ARE DEVICES DESIGNED TO PROTECT SOLAR SYSTEM PANELS FROM CIRCUIT OVERHEATING.

PROTECTION FROM OVERHEATING IN SOLAR PANEL SYSTEMS

The systems with solar thermal panels connected to the heat exchanger in the cylinders, when the desired storage temperature of the hot water is reached, stops the fluid circulator on the solar circuit.

In this situation the temperature inside the solar circuit increases up to reaching the condition of **STAGNATION**; in this condition the thermal energy that the panel receives from the sun is the same as that dispersed by the panel in the environment: there can be no further temperature increase inside the system.

This situation brings the circuit to very high temperatures, which can even reach 150 °C causing boiling and evaporation of the anti-freeze liquid.

With these high temperatures the anti-freeze fluid contained in the system undergoes alterations which make them very aggressive/corrosive and which can compromise the anti-freeze characteristics.

To reduce dilation of the fluid and steam which can form inside the solar circuit, expansion tanks must be installed suitable for solar systems.

TANKS FOR SOLAR SYSTEMS

62. DS-CE:

FIXED-BLADDER EXPANSION TANKS FOR SOLAR SYSTEMS (8 - 300 LITRES)

63. HOW TO SELECT THE RIGHT EXPANSION TANK FOR SOLAR SYSTEMS

64. STP:

TEMPERATURE REDUCING TANKS FOR SOLAR SYSTEMS (5 - 50 LITRES)



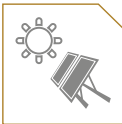

DS-CE

FIXED BLADDER EXPANSION TANKS FOR SOLAR SYSTEMS

(8 - 300 LITRI)



DS 18/P-24/P

DS 35/P-50/P

DS 8/35

DSV 50/300

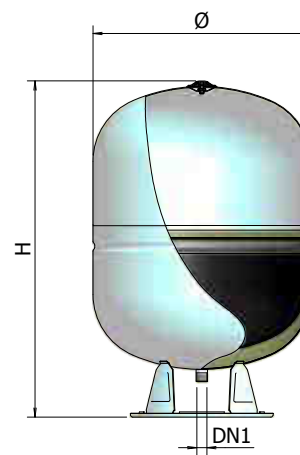
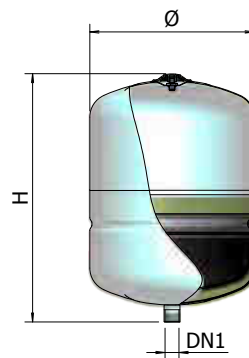
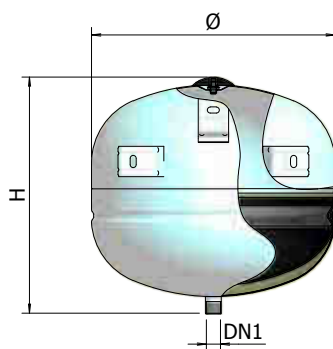
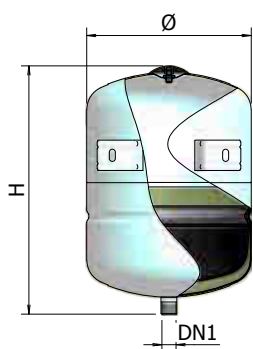

CE certified product

For heating systems

For air conditioning systems

For pressurisation systems

Water hammer arrestor

Inner protection TOP-PRO®

For solar systems

For non-drinking water

Characteristics:

• Lower shell (water side) with internal, anti-corrosive TOP-PRO® treatment.

• Water inlet attachment turned downwards.

• Long-lasting epoxy powder paint, white.

• SBR rubber bladder.

• Min./max. operating temperature: -10°/ +110°C, with a peak temperature: +130°C (max. 2 hours).

• Pre-charge pressure: 3 bar.





The expansion tanks of the DS series can be used both in heating systems and solar systems thanks to their internal, anti-corrosive TOP-PRO® treatment.

WARRANTY: 2 YEARS

Reference standard:

• Declaration of conformity to essential safety requirements specified in 2014/68/UE Directive.

DIMENSIONS

MODEL	CODE		Ppre	Pmax				DN1		NOTES
		LITRES	bar	bar	max	mm	mm		mm	
DS-8 CE	A222L16	8	3	8	110°C	205	280	3/4"	210 x 210 x 320	
DS-18 CE	A222L24	18	3	8	110°C	270	410	3/4"	280 x 280 x 310	
DS 18/p CE*	A232L24	18	3	8	110°C	270	410	3/4"	280 x 280 x 310	
DS-24 CE	A222L27	24	3	8	110°C	320	330	3/4"	330 x 330 x 375	
DS 24/p CE*	A232L27	24	3	8	110°C	320	330	3/4"	330 x 330 x 375	
DS-35 CE	A222L31	35	3	10	110°C	400	395	3/4"	410 x 410 x 410	
DS 35/p CE*	A232L31	35	3	10	110°C	400	395	3/4"	410 x 410 x 410	
DS 50/p CE*	A232L34	50	3	10	110°C	400	500	3/4"	410 x 410 x 535	
DSV-50 CE	A242L34	50	3	10	110°C	400	585	3/4"	410 x 410 x 535	
DSV-80 CE	A242L37	80	3	10	110°C	400	820	3/4"	410 x 410 x 860	
DSV-100 CE	A242L38	100	3	10	110°C	500	735	3/4"	510 x 510 x 830	
DSV-150 CE	A242L43	150	3	10	110°C	500	935	3/4"	510 x 510 x 1040	
DSV-200 CE	A242L47	200	3	10	110°C	600	1020	1"	610 x 610 x 1110	
DSV-300 CE	A242L51	300	3	10	110°C	650	1210	1"	660 x 660 x 1290	

*Version with wall fastening feet

HOW TO SELECT THE RIGHT EXPANSION TANK FOR SOLAR SYSTEMS

The expansion tank for solar systems must be sized correctly.

First of all, you must determine the expansion volume (the quantity of liquid that the expansion tank must absorb during the maximum expansion of the plant):

$$Ve = (VC * e + VP) * k$$

where:

Ve = expansion volume of the solar tank [litres]
 VC = solar circuit capacity [litres]
 e = dilation coefficient of the fluid

Example of values taken on by e:
 e = 0.045 (fluid: water)
 e = 0.070 (fluid: mix of water/glycol)

VP = capacity of solar panels [litres]
 K = 1.1 safety coefficient

Then you calculate the nominal volume of the solar tank:

$$VS = Ve * \frac{(P_F + 1)}{(P_F - P_I)}$$

VS = nominal volume of the solar tank [litres]
 Ve = expansion volume of the solar tank [litres]
 PI = Pre-charge pressure = system filling pressure [bar]
 PF = Calibration pressure of the safety valve [bar]

Having correctly sized the solar expansion tank, the best choice would be the **DS** series. Thanks to the special bladder and the internal, anti-corrosive TOP-PRO® treatment that guarantees greater resistance to high temperatures and protection against aggressive anti-freeze liquid, the expansion tanks of the **DS** series guarantee long duration of installation for solar thermal systems.

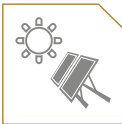

STP

TEMPERATURE REDUCING TANKS FOR SOLAR SYSTEMS

(5 - 50 LITRES)



STP 35/P - 50/P

STP 27

STP 5

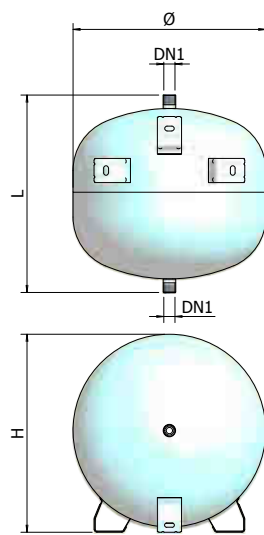
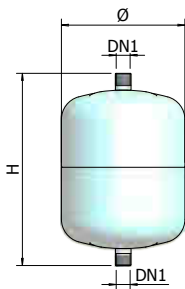

STP 35/P - 50/P

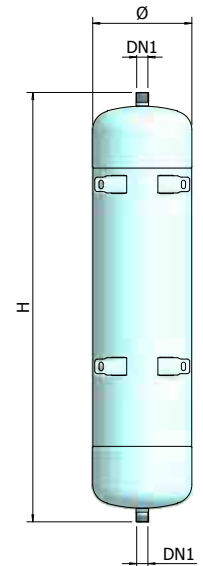

STP 27



FOR SOLAR SYSTEMS

The STP series temperature reducing tanks are to be installed in solar systems before the expansion tank. They are necessary to disperse heat and therefore reduce the working temperature. Their application guarantees greater duration of the solar expansion tank.

Characteristics:

- Long-lasting epoxy powder paint, white.
- Min./max. working temperature: -10° / +110°C with a peak temperature of +130°C (max. 2 hours).

Reference standard:

- In compliance with Art. 4.3. of the 2014/68/UE Directive without CE marking.

WARRANTY: 2 YEARS

DIMENSIONS

MODEL	CODE	LITRES	Pmax bar	Temperature bar	Diameter max	Height mm	Height mm	DN1	Dimensions mm	NOTES
STP-5	A270J11	5	8	110°C	205	240	-	3/4"	210 X 210 X 250	
STP-8	A270J16	8	8	110°C	205	320	-	3/4"	210 X 210 X 320	
STP-12	A270J20	12	8	110°C	270	315	-	3/4"	280 X 280 X 310	
STP-18	A270J24	18	8	110°C	270	420	-	3/4"	280 X 280 X 450	
STP-24	A270J27	24	8	110°C	320	335	-	3/4"	330 X 330 X 375	
STP-27	A270J29	27	8	110°C	205	890	-	3/4"	215 X 215 X 910	
STP-35	A270L31	35	10	110°C	400	415	405	3/4"	410 X 410 X 410	
STP-50	A270L34	50	10	110°C	400	415	520	3/4"	410 X 410 X 535	

The STP series temperature reducing tanks can also be used as DRAIN-BACK systems. The DRAIN-BACK systems protect the cylinder from overheating and the solar collectors from the risk of freezing.

When the temperature of the panels is lower than the cylinder temperature (Diagram A), the solar circuit pump is stopped and the fluid remains on the bottom part of the circuit (under the DRAIN-BACK level). By doing so, inverse heat exchange is avoided (therefore the cylinder grants heat to the panels circuit) as well as possible freezing of the panels during the winter period.

Instead, when the temperature of the panels is over the cylinder temperature (Diagram B), the solar circuit pump moves the fluid that goes to heat the cylinder heat exchanger.

To avoid overheating, you can stop the pump when the cylinder reaches temperatures that are too high (e.g. when the cylinder reaches 85 °C, the pump can be switched off and the solar fluid stays in the lower part of the circuit, thereby avoiding overheating).

This type of system means anti-freeze doesn't have to be used and also, since it is the closed circuit system, therefore without oxygen, the risk of corrosion is practically eliminated.

Since the system is pressurised, there is no need to install expansion tanks, safety valves, etc.

DIAGRAM A:

Temperature of panels lower than the cylinder temperature (night condition, poor insulation or winter)

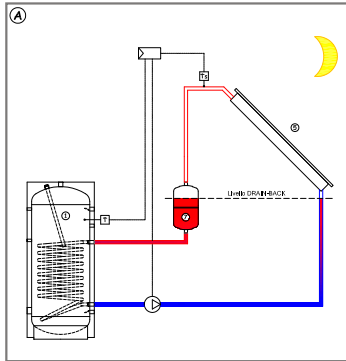
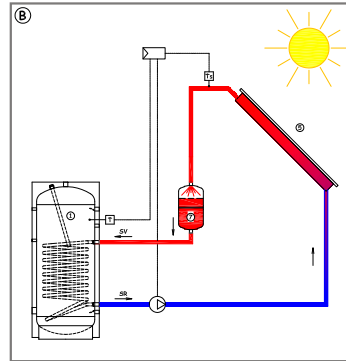
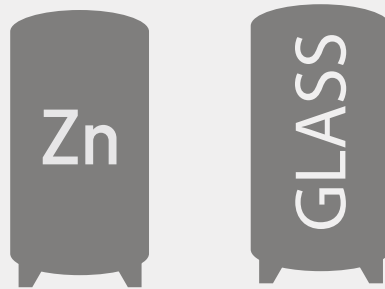

DIAGRAM B:

Temperature of panels over the cylinder temperature (good insulation condition)







GALVANIZED / GLASSLINED TANKS

GALVANIZED / GLASSLINED TANKS

GALVANIZED / GLASSLINED TANKS

AIR

Tanks with compressed air are used to rationalise use of the compressors in big compressed air systems and to maintain constant pressure in the system.

The AIR series tanks are CE certified as required by the 2014/68/UE Directive.

ACM/ACZ

Pressurised tanks with an air cushion for accumulation and pressurisation of cold water for residential/ industrial use. They are used in all systems where the water mains cannot meet the capacity and pressure demands.

The ACM/ACZ series autoclaves are CE certified as required by the 2014/68/UE Directive.

SC\E

The cold water storage tanks at atmospheric pressure can be used as first water tanks that are not pressurised or as pressurised storage tanks for cold water (accumulation without the air cushion). The tanks in the SC\E series are covered by Art. 4.3 of the 2014/68/UE Directive and are not subject to CE marking.

AR

AR accumulators were designed for installation as a thermal flywheel in air conditioning systems to optimise overall cooling inertia by increasing the volume of chilled water. The AR series is covered by Art. 4.3 of the 2014/68/UE Directive and are not subject to CE marking.

ARZ

The ARZ accumulators are designed to be installed as a thermal flywheel in air conditioning systems in order to optimise overall cooling inertia by increasing the volume of chilled water. The accumulators are supplied galvanized and coated with a finish of embossed aluminum sheet, and therefore they're suitable for outdoor installation. The ARZ series is covered by Art. 4.3 of the 2014/68/UE Directive and are not subject to CE marking.



GALVANIZED/GLASSLINED TANKS

70. AIR:

GALVANIZED TANKS FOR COMPRESSED AIR, CE CERTIFIED (750 - 10.000 LITRES)

72. ACM - ACZ:

GALVANIZED TANKS FOR COLD WATER, CE CERTIFIED (100 - 10.000 LITRES)

74. SC/E:

GALVANIZED TANK FOR COLD WATER, WITHOUT CE CERTIFICATION (100 - 5.000 LITRES)

76. AR:

GLASSLINED ACCUMULATORS FOR CHILLED WATER (100-5.000 LITRES)

78. ARZ:

GLASSLINED ACCUMULATORS FOR CHILLED WATER WITH ALUMINIUM INSULATION FOIL (100-5.000 LITRES)

79. GENERAL INSTRUCTIONS FOR THE CHOICE OF AN ACCUMULATOR

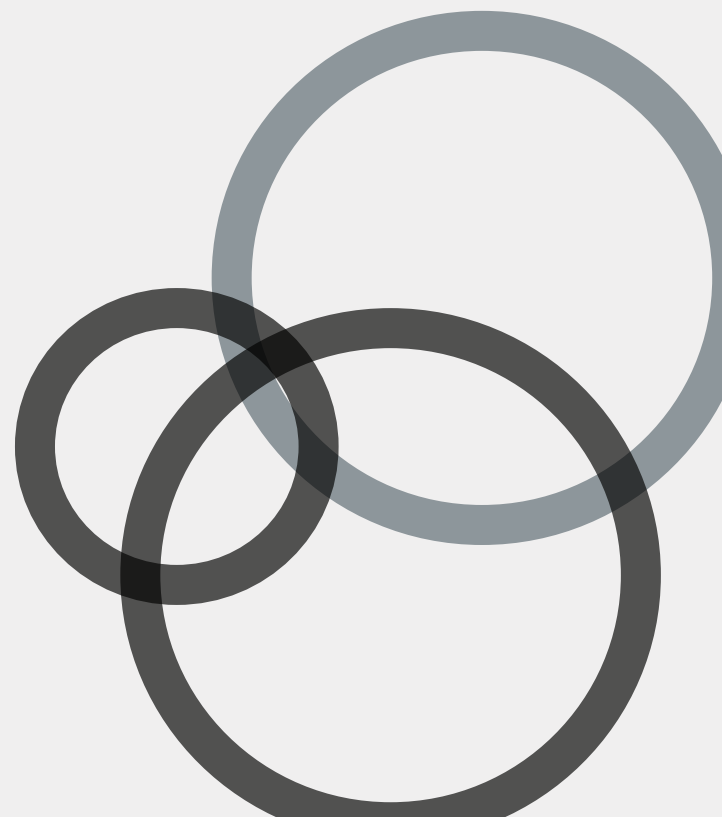

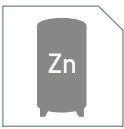

AIR

GALVANIZED TANKS FOR COMPRESSED AIR, CE CERTIFIED

(750-10.000 LITRES)



AIR

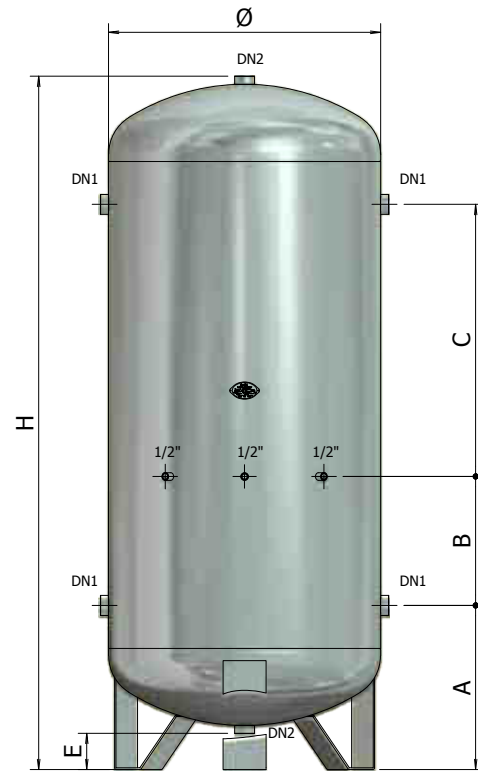

1500 ÷ 10000 (8 bar)
 1000 ÷ 10000 (12 bar)
 750 ÷ 2000 (16 bar)



CE certified product



For compressed air



Galvanized



For pressurisation system

Characteristics:

- Min./max. working temperature: -10° / +50°C

Reference standard

- Declaration of conformity to essential safety requirements according to 2014/68/UE Directive.



Notes

- Safety valve and gauge supplied on request.

Tanks with compressed air are used to rationalise use of the compressors in big compressed air systems and to maintain constant pressure in the system.
 The AIR series tanks are CE certified as required by the European Directive 97/23/EC (PED).

WARRANTY: 2 YEARS

DIMENSIONS

MODEL	CODE		P max			A	B	C	E	DN1	DN2	NOTES
		LITRES	bar	mm	mm	mm	mm	mm	mm			
AIR 1500/8	A4K2J67	1500	8	950	2425	565	450	950	105	2"	2"	
AIR 2000/8	A4K2J70	2000	8	1100	2485	595	500	900	105	2"	2"	
AIR 2500/8	A4K2J72	2500	8	1250	2545	635	530	870	95	3"	2"	
AIR 3000/8	A4K2J74	3000	8	1250	2845	615	800	900	95	3"	2"	
AIR 4000/8	A4K2J77	4000	8	1400	2960	725	800	900	145	3"	2"	
AIR 5000/8	A4K2J80	5000	8	1550	3025	715	800	900	95	4"	2"	
AIR 7500/8	A4K2J87	7500	8	1650	4175	895	1200	1400	205	4"	2"	
AIR 10000/8	A4K2J92	10000	8	1650	5175	895	1200	2400	205	4"	2"	
AIR 1000/12	A4K2N62	1000	12	800	2370	565	550	850	130	1"1/2	1"1/2	
AIR 1500/12	A4K2N67	1500	12	950	2425	565	450	950	105	2"	2"	
AIR 2000/12	A4K2N70	2000	12	1100	2485	595	500	900	105	2"	2"	
AIR 2500/12	A4K2N72	2500	12	1250	2545	635	530	870	95	3"	2"	
AIR 3000/12	A4K2N74	3000	12	1250	2845	615	800	900	95	3"	2"	
AIR 4000/12	A4K2N77	4000	12	1400	2960	725	800	900	145	3"	2"	
AIR 5000/12	A4K2N80	5000	12	1550	3025	715	800	900	95	4"	2"	
AIR 7500/12	A4K2N87	7500	12	1650	4175	895	1200	1400	205	4"	2"	
AIR 10000/12	A4K2N92	10000	12	1650	5175	895	1200	2700	205	4"	2"	
AIR 750/16	A4K2R59	750	16	750	2080	565	445	655	170	1"1/2	1"1/2	
AIR 1000/16	A4K2R62	1000	16	800	2370	565	550	850	130	1"1/2	1"1/2	
AIR 1500/16	A4K2R67	1500	16	950	2425	565	450	950	105	2"	2"	
AIR 2000/16	A4K2R70	2000	16	1100	2485	605	500	900	105	2"	2"	



ACM - ACZ

GALVANIZED TANKS FOR COLD WATER, CE CERTIFIED

(100-10.000 LITRES)



ACZ 750 - 10.000

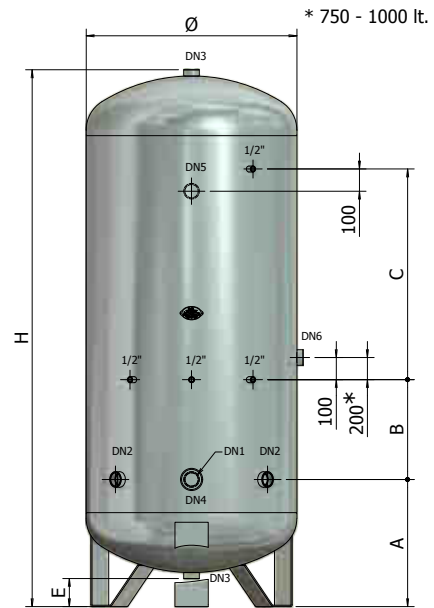

ACZ 200 - 500

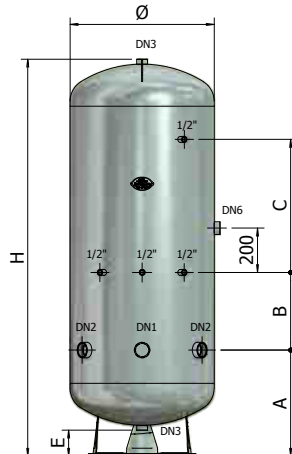

ACM 100 - 500



CE certified product



Galvanized



For pressurisation systems

ACM: two sleeve mode
ACZ: traditional model

Pressurised tanks with an air cushion for storage and pressurisation of cold water for residential/industrial use. They are used in all plants where the water mains cannot meet the capacity and pressure demands.

The Galvanized autoclaves of ACM/ACZ series must be supplied with:

- WATER through electric pumps with features that meet the system requirements.
- AIR through the compressor or compressed air network, in order to maintain the air cushion constant.

The air cushion will keep pressure constant in the system and protect the pumps from continuous starts due to intake from the mains water supply.

Safety valve and gauges supplied on request.

WARRANTY: 2 YEARS

Characteristics:

- Min./max. working temperature: -10° - +50°C

Reference standard:

- Declaration of conformity to essential safety requirements according to 2014/68/UE Directive.

Installation:

- For hydronic systems

HOW TO SIZE AN AIR CUSHION AUTOCLAVE

Calculation of the total volume of the autoclave:

$$V = 30 \times \frac{Q_{\max} \times 60}{A} \times \frac{P_1 + 100}{P_1 - P_2}$$

where:

V = volume of the autoclave [litres]

Q_{max} = maximum simultaneous capacity to supply to the utilities [l/s]

A = maximum number of start-ups of the pump per hour

P_s = pump stop pressure [kPa]

P_a = pump start pressure [kPa]

Calculation of the volume of the air cushion on pump start:

$$V_a = \frac{V}{1,25} = 0,80 \times V$$

where:

V_a = volume of the air cushion [litres]

V = volume of the autoclave [litres]

DIMENSIONS

MODEL	CODE	LITRES	P max	mm	mm	A	B	C	E	DN1	DN2	DN3	DN4	DN5	DN6	NOTES
ACM 100/10	A402L38	100	10	500	780	310	490	-	90	-	1"	-	-	-	1"1/4	
ACM 200/10	A402L47	200	10	600	1020	360	675	-	115	-	1"1/4	-	-	-	1"1/4	
ACM 300/10	A402L51	300	10	650	1205	375	795	-	135	-	1"1/4	-	-	-	1"1/4	
ACM 500/10	A402L55	500	10	775	1405	480	940	-	125	-	1"1/2	-	-	-	1"1/2	
ACZ 200/ 8	A432J47	200	8	500	1340	385	255	430	110	1"1/2	1"1/2	1"1/4	-	-	1"1/2	
ACZ 300/ 8	A432J51	300	8	550	1500	420	290	430	100	2"	2"	1"1/4	-	-	1"1/2	
ACZ 500/ 8	A432J55	500	8	650	1790	480	350	600	105	2"	2"	1"1/4	-	-	1"1/2	
ACZ 750/ 8	A432J59	750	8	750	2080	575	450	700	170	2"	2"	1"1/2	-	-	1"1/2	
ACZ 1000/ 8	A432J62	1000	8	800	2370	565	550	850	130	2"	2"	1"1/2	-	-	1"1/2	
ACZ 1500/ 8	A432J67	1500	8	950	2425	575	450	950	105	2"	2"	2"	-	-	1"1/2	
ACZ 2000/8	A432J70	2000	8	1100	2485	595	500	900	105	2"	2"	2"	-	-	1"1/2	
ACZ 2500/8	A432J72	2500	8	1250	2545	615	530	870	95	3"	2"1/2	2"	2"	-	1"1/2	
ACZ 3000/ 8	A432J74	3000	8	1250	2845	615	800	900	95	3"	2"1/2	2"	2"	-	1"1/2	
ACZ 4000/ 8	A432J77	4000	8	1400	2960	695	800	900	145	3"	2"1/2	2"	2"	-	1"1/2	
ACZ 5000/ 8	A432J80	5000	8	1550	3025	715	800	900	95	3"	2"1/2	2"	2"	-	1"1/2	
ACZ 7500/ 8	A432J87	7500	8	1650	4175	895	1200	1450	205	3"	2"1/2	2"	2"	2"	1"1/2	
ACZ 10000/ 8	A432J92	10000	8	1650	5175	895	1200	2450	205	3"	2"1/2	2"	2"	2"	1"1/2	
ACZ 200/12	A432N47	200	12	500	1340	385	255	430	110	1"1/2	1"1/2	1"1/4	-	-	1"1/2	
ACZ 300/12	A432N51	300	12	550	1500	420	290	490	100	2"	2"	1"1/4	-	-	1"1/2	
ACZ 500/12	A432N55	500	12	650	1790	480	350	600	105	2"	2"	1"1/4	-	-	1"1/2	
ACZ 750/12	A432N59	750	12	750	2080	575	450	700	170	2"	2"	1"1/2	-	-	1"1/2	
ACZ 1000/12	A432N62	1000	12	800	2370	565	550	150	130	2"	2"	1"1/2	-	-	1"1/2	
ACZ 1500/12	A432N67	1500	12	950	2425	575	450	950	105	2"	2"	2"	-	-	1"1/2	
ACZ 2000/12	A432N70	2000	12	1100	2485	595	500	900	105	2"	2"	2"	-	-	1"1/2	
ACZ 2500/12	A432N72	2500	12	1250	2545	615	530	870	95	3"	2"1/2	2"	-	-	1"1/2	
ACZ 3000/12	A432N74	3000	12	1250	2845	615	800	900	95	3"	2"1/2	2"	3"	-	1"1/2	
ACZ 4000/12	A432N77	4000	12	1400	2960	695	800	900	145	3"	2"1/2	2"	2"	-	1"1/2	
ACZ 5000/12	A432N80	5000	12	1550	3025	715	800	900	95	3"	2"1/2	2"	2"	-	1"1/2	
ACZ 7500/12	A432N87	7500	12	1650	4175	895	1200	1450	205	3"	2"1/2	2"	2"	2"	1"1/2	
ACZ 10000/12	A432N92	10000	12	1650	5175	895	1200	2150	205	3"	2"1/2	2"	2"	2"	1"1/2	
ACZ 200/16	A432R47	200	16	500	1340	385	255	430	110	1"1/2	1"1/2	1"1/4	-	-	1"1/2	
ACZ 300/16	A432R51	300	16	550	1500	420	290	490	100	3"	3"	1"1/4	-	-	1"1/2	
ACZ 500/16	A432R55	500	16	650	1790	480	350	600	105	2"	2"	1"1/4	-	-	1"1/2	
ACZ 750/16	A432R59	750	16	750	2080	575	450	700	170	2"	2"	1"1/2	-	-	1"1/2	
ACZ 1000/16	A432R62	1000	16	800	2370	565	550	850	130	2"	2"	1"1/2	-	-	1"1/2	
ACZ 1500/16	A432R67	1500	16	950	2425	575	450	950	105	2"	2"	2"	-	-	1"1/2	
ACZ 2000/16	A432R70	2000	16	1100	2485	595	500	900	105	2"	2"	2"	-	-	1"1/2	

Table of the pressure switch calibrations for some building heights

Building height Max (m)	8	10	12	14	16	18	20	22	24	26	28	30	32	34	36	38	40	42
Minimum pressure P ₁ (bar)	2,0	2,2	2,5	2,7	3,0	3,2	3,4	3,7	4,0	4,2	4,4	4,6	4,9	5,1	5,3	5,6	5,8	6,0
Maximum pressure P ₂ (bar)	3,0	3,2	3,5	3,7	4,0	4,2	4,4	4,7	5,0	5,2	5,4	5,6	5,9	6,1	6,3	6,6	6,8	7,0

These calibrations enable circa 1 atmosphere of minimum pressure on use in the highest intake point.

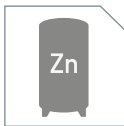

SC/E

GALVANIZED TANKS FOR COLD WATER, WITHOUT CE CERTIFICATION

(100 - 5.000 LITRES)

SC/E 750 - 5000



SC/E 100 - 500

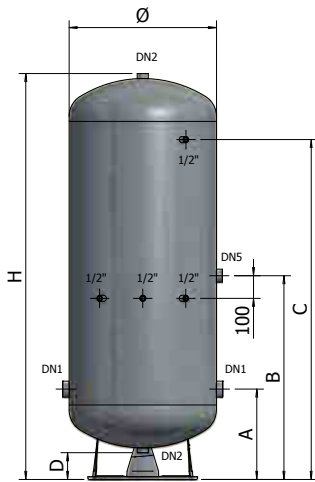

SC/E2 100 - 500

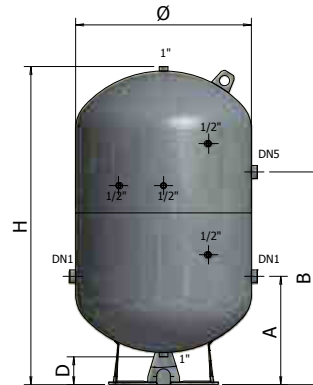

For drinking water



Galvanized



For pressurisation systems

Characteristics:

- Min./max. working temperature: -10° - +50°C



Reference standard:

- Complies with Art. 4.3 of the 2014/68/UE Directive with CE marking.

The SC/E cold water storage tanks can be used as first water tanks that are not pressurised or as pressurised storage tanks for cold water (accumulation without the air cushion).

WARRANTY: 2 YEARS

DIMENSIONS

MODEL	CODE		P			A	B	C	D	DN1	DN2	DN3	DN4	DN5	NOTES
		LITRES	max	mm	mm	mm	mm	mm	mm						
SC/E2 100	1550101	100	10	500	780	310	490	-	90	1"	-	-	-	1"1/4	
SC/E2 200	1550209	200	10	600	1020	360	675	-	115	1"1/4	-	-	-	1"1/4	
SC/E2 300	1550306	300	10	650	1205	375	795	-	135	1"1/4	-	-	-	1"1/4	
SC/E2 500	1550403	500	10	775	1405	480	940	-	125	1"1/2	-	-	-	1"1/2	
SC/E 100	1550110	100	10	400	965	265	515	765	90	1"	1"1/4	-	-	1"1/4	
SC/E 200	1550220	200	10	500	1255	345	735	985	115	2"	1"1/4	-	-	1"1/2	
SC/E 300	1550350	300	10	550	1505	410	690	1190	120	2"	1"1/4	-	-	1"1/2	
SC/E 500	1550420	500	10	650	1800	410	910	1510	130	2"	1"1/4	-	-	1"1/2	
SC/E 750	1550501	750	6	800	1920	485	985	1585	160	2"	1"1/2	-	-	1"1/2	
SC/E 1000	1550608	1000	6	800	2170	485	1010	1740	160	2"	1"1/2	-	-	1"1/2	
SC/E 1500	1550705	1500	6	1000	2475	550	1150	1850	125	2"	2"	-	-	1"1/2	
SC/E 2000	1550802	2000	6	1100	2445	525	1175	2025	110	2"	2"	-	-	1"1/2	
SC/E 3000	1551001	3000	6	1250	2825	565	1355	2255	90	2"1/2	2"	1"1/2	2"1/2	1"1/2	
SC/E 5000	1551205	5000	6	1600	3035	680	1470	2370	105	2"1/2	2"	1"1/2	2"1/2	1"1/2	





AR

GLASSLINED ACCUMULATORS FOR CHILLED WATER

(100 - 5.000 LITRES)



1500- 5000 I. VERSION
(WITH SKIRT)

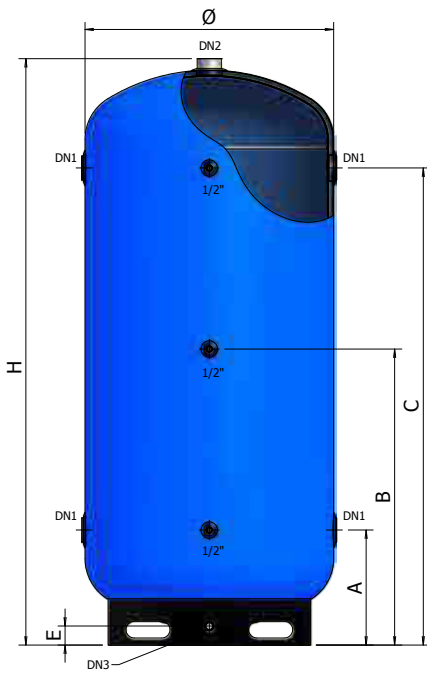

200 - 1000 I. VERSION
(WITH SKIRT)

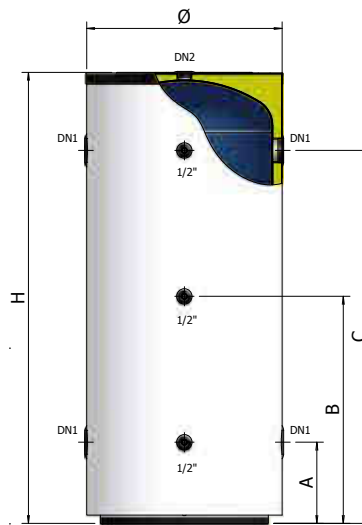

100 I. VERSION
(WITHOUT BASE)

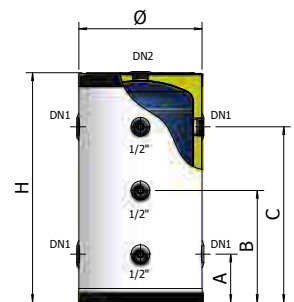

For chilled water



Not for drinking water



For air conditioning systems



Polyurethane insulation



Internal, glasslined anti-corrosion treatment



Handling by forklift

CHARACTERISTICS:

- Min./max. working temperature: -10° / +95°C (100 - 1000 l)
- Min./max. working temperature: -10° / +50°C (1500 - 5000 l)

REFERENCE STANDARDS

TANKS:

- Complies with Art. 4.3 of the 2014/68/UE Directive without CE marking.

INTERNAL GLASSLINING:

DIN 4753





The glasslining treatment makes the cylinder suitable to contain hot water and resistant to corrosive phenomena.

INSTALLATION:

- Use as a thermal flywheel in air conditioning systems to optimise cooling inertia by increasing the volume of chilled water.

WARRANTY: 5 YEARS

DIMENSIONS

MODEL	CODE	 LITRES	 P _{max} bar	 mm	 mm	A	B	C	E	DN1	DN2	DN3	NOTES
						mm	mm	mm	mm				
AR 100	1681124	100	10	460	885	185	425	665	-	1"1/2	1"1/4	-	
AR 200	1681129	200	10	600	1160	260	590	920	-	1"1/2	1"1/4	-	
AR 300	1681133	300	10	650	1400	285	710	1135	-	2"	1"1/4	-	
AR 500	1681135	500	10	750	1695	320	855	1390	-	3"	1"1/4	-	
AR 800	1681139	800	10	900	1785	370	905	1440	-	3"	1"1/2	-	
AR 1000	1681141	1000	10	900	2035	370	1030	1690	-	3"	1"1/2	-	
AR 1500	A460H67 VB120	1500	6	1040	2465	485	1245	2005	80	3"	3"	1"	
AR 2000	A460H70 VB120	2000	6	1140	2445	475	1235	1995	80	3"	3"	1"	
AR 3000	A460H74 VB120	3000	6	1290	2840	540	1430	2320	80	4"	3"	1"	
AR 5000	A460H80 VB120	5000	6	1640	3045	645	1535	2425	80	4"	3"	1"	

The AR accumulators are designed to be installed as a thermal flywheel in air conditioning systems in order to optimise overall cooling inertia by increasing the volume of chilled water.

The additional accumulation also enables less frequent intervention on the cooling units, making them therefore easier on the motors and the equipment.

The accumulators were built using quality sheet metal and are welded using automatic procedures that guarantee a high level of quality.

They are supplied with threaded connections suitable for their type of use.

The accumulators are supplied with an inner, glasslined, anti-corrosive treatment.

GENERAL INSTRUCTIONS FOR THE CHOICE OF AN ACCUMULATOR

A practical and useful formula to determine the accumulation volume is as follows:

$$C = \frac{W \cdot 4}{60 \Delta T}$$

where:

C = is the necessary accumulator volume (litres)

W = is the power of the cooling unit (W)

ΔT = is the difference between the minimum and maximum working temperature (°C)

Another practical method, used to choose the accumulation volume, is to foresee the total volume (accumulator + system) proportional to the power according to the values outlined below:

- | | |
|---|---------------------------|
| 1) ON-OFF systems: | 24 litres per kW of power |
| 2) systems with two partialisation levels: | 12 litres per kW of power |
| 3) systems with four partialisation levels: | 6 litres per kW of power |

TECHNICAL CHARACTERISTICS

MODEL	TYPE OF INSULATION	THICKNESS OF INSULATION	DENSITY OF INSULATION	INITIAL THERMAL CONDUCTIVITY	EXTERNAL COVER
AR 100	95% closed cells rigid expanded polyurethane, CFC - HCFC free	30 mm	40 kg/m ³	23,5 mW/m K	Grey polystyrene RAL 9006
AR 200					
AR 300					
AR 500					
AR 800					
AR 1000	Closed cell, cross-linked polyethylene	20 mm	30 kg/m ³	37,0 mW/m K	Skay blue RAL 5015
AR 1500					
AR 2000					
AR 3000					
AR 5000					

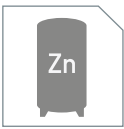

ARZ

GALVANIZED ACCUMULATORS FOR CHILLED WATER WITH ALUMINIUM INSULATION FOIL

(100 - 5.000 LITRES)

ARZ 100 - 500

ARZ 1500-5000

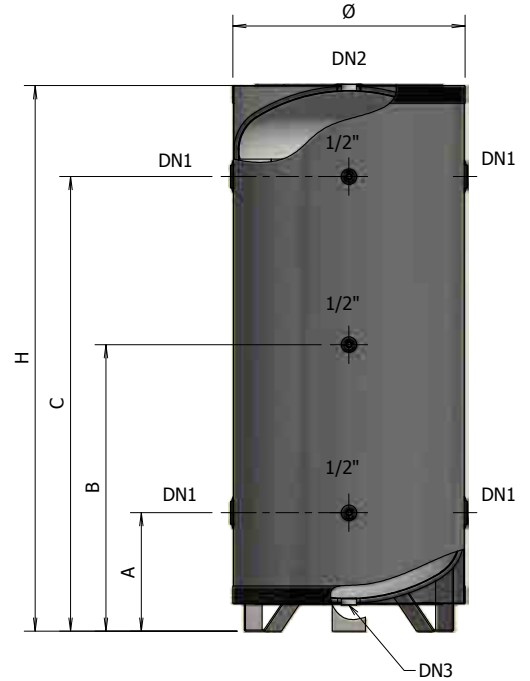
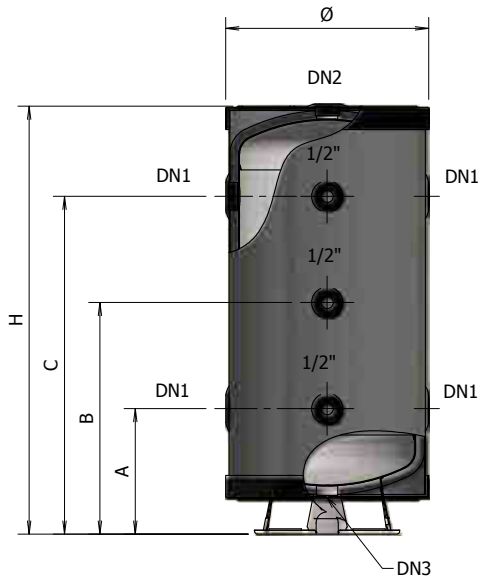

FOR CHILLED WATER



NOT FOR DRINKING WATER



FOR AIR CONDITIONING SYSTEMS



GALVANIZED

CHARACTERISTICS:

- Min./max. working temperature: -10° / +50°C

REFERENCE STANDARDS

TANKS:

- Complies with Art. 4.3 of the 2014/68/UE Directive without CE marking.

INSTALLATION:

- The ARZ cold water storage tanks can be used as pressurised storage tanks for cold water (accumulation without the air cushion).

WARRANTY: 5 YEARS

DIMENSIONS

MODEL	CODE	LITRES	P max bar	mm	mm	A mm	B mm	C mm	DN1	DN2	DN3	NOTES
ARZ 100	A460L38 ZL120	100	10	440	965	215	455	695	1"1/2	1"1/4	1"1/4	
ARZ 200	A460L47 ZL120	200	10	540	1255	360	690	1020	1"1/2	1"1/4	1"1/4	
ARZ 300	A460L51 ZL120	300	10	590	1505	385	810	1235	2"	1"1/4	1"1/4	
ARZ 500	A460L55 ZL120	500	10	690	1800	430	965	1500	3"	1"1/4	1"1/4	
ARZ 800	A460L60 ZL120	800	10	840	1920	505	1040	1575	3"	1"1/2	1"1/2	
ARZ 1000	A460L62 ZL120	1000	10	840	2170	505	1165	1825	3"	1"1/2	1"1/2	
ARZ 1500	A460H67 ZL120	1500	6	1040	2475	535	1295	2055	3"	2"	2"	
ARZ 2000	A460H70 ZL120	2000	6	1140	2440	515	1275	2035	3"	2"	2"	
ARZ 3000	A460H74 ZL120	3000	6	1290	2825	565	1455	2345	3"	2"	2"	
ARZ 5000	A460H80 ZL120	5000	6	1640	3035	680	1570	2460	4"	2"	2"	

The ARZ accumulators are designed to be installed as a thermal flywheel in air conditioning systems in order to optimise overall cooling inertia by increasing the volume of chilled water.

The additional accumulation also enables less frequent intervention on the cooling units, making them therefore easier on the motors and the equipment. The accumulators were built using quality sheet metal and are welded using automatic procedures that guarantee a high level of quality.

They are supplied with threaded connections suitable for their type of use.

The accumulators are supplied galvanized and insulated, and they are also suitable for outdoor installation.

GENERAL INSTRUCTIONS FOR THE CHOICE OF AN ACCUMULATOR

A practical and useful formula to determine the accumulation volume is as follows:

$$C = \frac{W \cdot 4}{60 \Delta T}$$

where:

C = is the necessary accumulator volume (litres)

W = is the power of the cooling unit (W)

ΔT = is the difference between the minimum and maximum working temperature (°C)

Another practical method, used to choose the accumulation volume, is to foresee the total volume (accumulator + system) proportional to the power according to the values outlined below:

- | | |
|---|---------------------------|
| 1) ON-OFF systems: | 24 litres per kW of power |
| 2) systems with two partialisation levels: | 12 litres per kW of power |
| 3) systems with four partialisation levels: | 6 litres per kW of power |

TECHNICAL CHARACTERISTICS

MODEL	TYPE OF INSULATION	THICKNESS OF INSULATION	DENSITY OF INSULATION	INITIAL THERMAL CONDUCTIVITY	EXTERNAL COVER
ARZ 100	Closed cell, cross-linked polyethylene	20 mm	30 kg/m ³	37,0 mW/m K	embossed aluminum sheet
ARZ 200					
ARZ 300					
ARZ 500					
ARZ 800					
ARZ 1000					
ARZ 1500					
ARZ 2000					
ARZ 1500					
ARZ 2000					



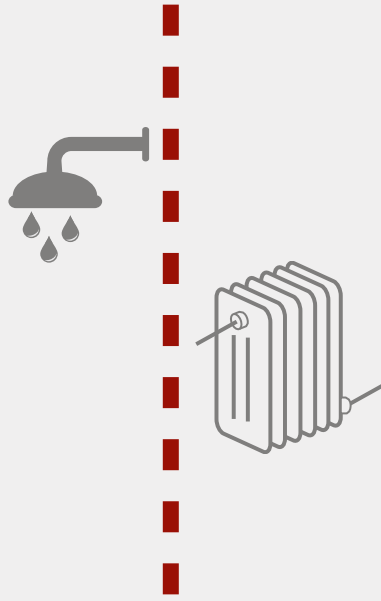

HOT WATER TANKS

HOT WATER TANKS ACCUMULATORS

THE ELBI HOT WATER TANKS - ACCUMULATORS ARE SUITABLE FOR INSTALLATION ON RESIDENTIAL AND INDUSTRIAL SYSTEMS TO PRODUCE AND ACCUMULATE HOT WATER FOR SANITARY-HYGIENE PURPOSES THANKS TO THEIR FUNCTIONALITY AND RELIABILITY.

The various product lines offer the possibility of finding an adequate answer to numerous problems that designers and/or installation technicians have to deal with when implementing systems with a high level of thermal efficiency.

Why using an ELBI hot water tank - accumulator:

ANTI-CORROSION TREATMENT

Glasslining treatment according to standard **DIN 4753**.

It is composed of a first sandblast phase of the cylinders for internal washing, followed by a liquid enamel application phase and finally glasslining in the furnace at 900°C. The entire cycle is automated and controlled electronically in each phase; the operators carry out the supervision and loading/unloading.

The system enables a glasslining manufacturing capacity to be achieved up to 100 cylinders per work shift. Each piece is checked and tested at the end of the cycle according to strict criteria based on standard DIN 4753

INSULATION

Elbi Hot Water Cylinders and Storage tanks come with rigid expanded polyurethane insulation CFC and HCFC free, or with open cells flexible expanded polyurethane insulation. The insulation thickness varies with the cylinder size to obtain the lowest thermal loss from the cylinders.

STAINLESS STEEL

It's available a wide range of stainless steel cylinder - hot water tanks - accumulators, which guarantee an excellent level of corrosion resistance without the need of sacrificial anodes or other devices and protective treatments.

CATHODIC PROTECTION WITH SACRIFICIAL ANODE

Cathodic Protection with a sacrificial anode is an electrochemical technique used to screen out the metal surfaces from the corrosion exposed to an electrolytic environment (soil, seawater, freshwater, chemical substances, concrete, etc.).

The easiest way to apply protection with sacrificial anode is to connect the metal to be protected with another metal that corrodes, called "sacrificial metal". The sacrificial metal then corrodes instead of the metal to keep protected.

The cylinders - hot water storage tanks are standard equipped with a magnesium anode. The magnesium anodes used can be of three types:

- **Magnesium anode SIMPLETEST.** The actual wear out of the anode can be tested by checking the valve connected on the plug. The water coming out of the valve clearly indicates that the anode must be replaced. The anode is connected to the cylinder through an electric cable.
- **Magnesium anode with TESTER.** The actual wear out of the anode can be tested by simply pressing the button on the tester. The anode is connected to the cylinder through an electric cable.
- **Magnesium anode with isolated plug.**

IMPRESSED CURRENT CATHODIC PROTECTION

Cathodic protections with Titanium Anode are supplied on request.

This special anode ensures an electrical potential to the electrolyte (water) using an impressed continuous current. In this way the water is electrically polarised, obtaining permanent protection without the need for periodic check-ups and maintenance by the operators.

IMPORTANT NOTICE - FOR USE WITH STEAM

(read carefully instructions sheet)

For all BSH, BSV, BSM, BST Cylinders series:

Heat Exchanger: Max Work. Pressure: 1 bar / Max Work. Temp.: +120° C.

For all BF-1, BF-2, BF-3 Cylinders series:

Heat Exchanger: Max Work. Pressure: 2 bar - Max Work. Temp.: +134° C.

If temperature in the primary circuit exceeds 100°C, special gaskets for use with steam shall be ordered with the cylinder.

Safety devices shall be installed to cut-off the steam heat source to avoid overheating in the cylinder.

HOT WATER TANKS - ACCUMULATORS

84. HOW TO SELECT THE VOLUME OF AN ELBI HOT WATER CYLINDER-ACCUMULATOR

86. BSH: GLASSLINED CYLINDER WITH FIXED HEAT EXCHANGER FOR SANITARY HOT WATER, WALL MOUNTING (100 - 300 LITRES)

88. BSH: THERMAL YIELD AND HYDRAULIC DIAGRAMS

90. BSV: GLASSLINED CYLINDER WITH FIXED HEAT EXCHANGER FOR SANITARY HOT WATER (150 - 2.000 LITRES)

93. BSV: THERMAL YIELD AND HYDRAULIC DIAGRAMS

96. BSP: GLASSLINED DHW CYLINDER WITH FIXED EXCHANGER FOR HEAT PUMPS

98. BSP: THERMAL YIELD AND HYDRAULIC DIAGRAMS

100. BSM: HIGH PERFORMANCES GLASSLINED CYLINDER WITH FIXED HEAT EXCHANGER FOR SANITARY HOT WATER (150 - 1.000 LITRES)

103. BSM: THERMAL YIELD AND HYDRAULIC DIAGRAMS

106. BST: GLASSLINED CYLINDER FOR SOLAR THERMAL USE WITH TWO FIXED EXCHANGERS (200 - 2.000 LITRES)

110. BST: THERMAL YIELD AND HYDRAULIC DIAGRAMS

114. BSPT: GLASSLINED DHW CYLINDER WITH TWO FIXED EXCHANGERS FOR HEAT PUMPS (300-1.000 LITRES)

116. BSPT: THERMAL YIELD AND HYDRAULIC DIAGRAMS

118. BXV: STAINLESS STEEL CYLINDER WITH FIXED HEAT EXCHANGER FOR SANITARY HOT WATER (170 - 1.000 LITRES)

121. BXV: THERMAL YIELD AND HYDRAULIC DIAGRAMS

124. BXP: STAINLESS STEEL DHW CYLINDER WITH FIXED EXCHANGER FOR HEAT PUMPS (300-1.000 LITRES)

126. BXP: THERMAL YIELD AND HYDRAULIC DIAGRAMS

128. BXT: STAINLESS STEEL CYLINDER WITH TWO FIXED HEAT EXCHANGERS FOR SOLAR THERMAL USE (200 - 1.500 LITRES)

132. BXT: THERMAL YIELD AND HYDRAULIC DIAGRAMS

136. BXPT: STAINLESS STEEL DHW CYLINDER WITH TWO FIXED EXCHANGERS FOR HEAT PUMPS (300-1.000 LITRES)

138. BXPT: THERMAL YIELD

140. SXC: STAINLESS STEEL ACCUMULATORS FOR SANITARY HOT WATER (100-900 LITRES)

144. COMBI: MULTY ENERGY BUFFER TANKS FOR STORAGE OF HOT WATER FOR HEATING & DHW PRODUCTION (500 - 1.000 LITRES)

147. COMBI: THERMAL YIELD AND HYDRAULIC DIAGRAMS

150. COMBI QUICK: MULTY ENERGY BUFFER TANKS FOR STORAGE OF HOT WATER FOR HEATING & INSTANT DHW PRODUCTION (500 - 1.000 LITRES)

153. COMBI QUICK: THERMAL YIELD AND HYDRAULIC DIAGRAMS

156. BF1: GLASSLINED CYLINDERS WITH REMOVABLE STAINLESS STEEL HEAT EXCHANGER (1.500 - 5.000 LITRES)

159. BF1: THERMAL YIELD AND HYDRAULIC DIAGRAMS

162. BF2: GLASSLINED CYLINDERS WITH TWO REMOVABLE STAINLESS STEEL HEAT EXCHANGERS (1.500 - 5.000 LITRES)

165. BF2: THERMAL YIELD AND HYDRAULIC DIAGRAMS

168. BF3: GLASSLINED CYLINDERS WITH THREE REMOVABLE STAINLESS STEEL HEAT EXCHANGERS (1.500 - 5.000 LITRES)

171. BF3: THERMAL YIELD AND HYDRAULIC DIAGRAMS

174. BG: MULTI-PURPOSE GLASSLINED BUFFER TANKS WITH TRIPLE FLANGED OPENINGS (800 - 5.000 LITRES)

177. BG: THERMAL YIELD AND HYDRAULIC DIAGRAMS

180. SAC: GLASSLINED ACCUMULATORS FOR SANITARY HOT WATER (300 - 5.000 LITRES)

184. PUFFER: HEATED WATER BUFFER TANKS FOR HEATING APPLICATIONS (300 - 5.000 LITRES)

188. PUFFER PLUS: HEATED WATER BUFFER TANKS FOR HEATING APPLICATIONS WITH MULTIPLE CONNECTIONS (100 - 5.000 LITRES)

192. ACP: INERTIAL ACCUMULATORS FOR HEAT PUMPS WALL MOUNTING (35 - 50 LITRES)

194. ACF: THERMAL FLYHEEL FOR AIR CONDITIONING / HEATING SYSTEMS (100-5.000 LITRES)

196. PPS1: BUFFER TANK FOR HEATING SYSTEMS WITH FIXED SPIRAL COIL FOR HEATING APPLICATIONS (300 - 2.000 LITRES)

198. PPS1: THERMAL YIELD AND HYDRAULIC DIAGRAMS

200. PPS2: BUFFER TANK FOR HEATING SYSTEMS WITH TWO FIXED SPIRAL COILS FOR HEATING APPLICATIONS (300 - 2.000 LITRES)

202. PPS2: THERMAL YIELD AND HYDRAULIC DIAGRAMS

204. BSE: GLASSLINED ACCUMULATORS FOR SANITARY HOT WATER WITH PLATE HEAT EXCHANGERS (300-2000 LITRES)

206. BSE: THERMAL YIELD AND HYDRAULIC DIAGRAMS

208. SPI: GASKETED PLATE HEAT EXCHANGERS

210. SSB: BRAZED PLATE HEAT EXCHANGERS

212. TABLE OF HEATING ELEMENT APPLICABILITY TO CYLINDERS

213. MAINTENANCE OF GLASSLINED CYLINDERS

AVERAGE HOT WATER REQUIREMENT AT 40°C:

Type of installation	Type of utility	Litres / person-day
Homes	popular	from 40 to 50
	medium	from 70 to 80
	residential	from 150 to 200
Sport centres, gyms, swimming pools	-	from 50 to 60
Hospitals, clinics	-	from 130 to 150
Offices	-	from 15 to 200
Dressing rooms in buildings	-	from 30 to 50
Hotels	Rooms with bathroom and bathtub	from 180 to 200
	Rooms with bathroom and shower	130

HOT WATER REQUIREMENT FOR EQUIPMENT ON EACH USE:

Type of installation	LITRES
Bathtub 170cm x 70cm	from 160 to 200
Bathtub 105cm x 70cm	100 to 120
Shower	from 50 to 60
Wash basin	from 10 to 12
Kitchen sink	from 15 to 20

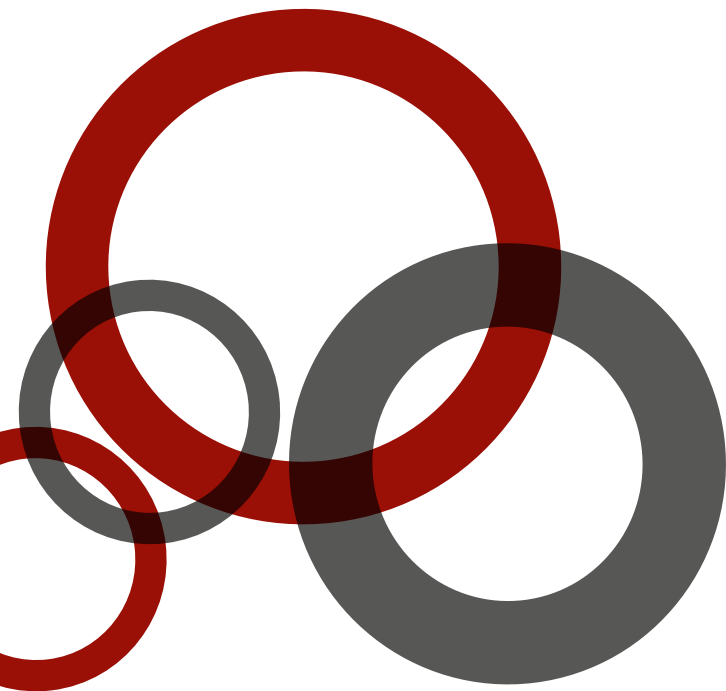

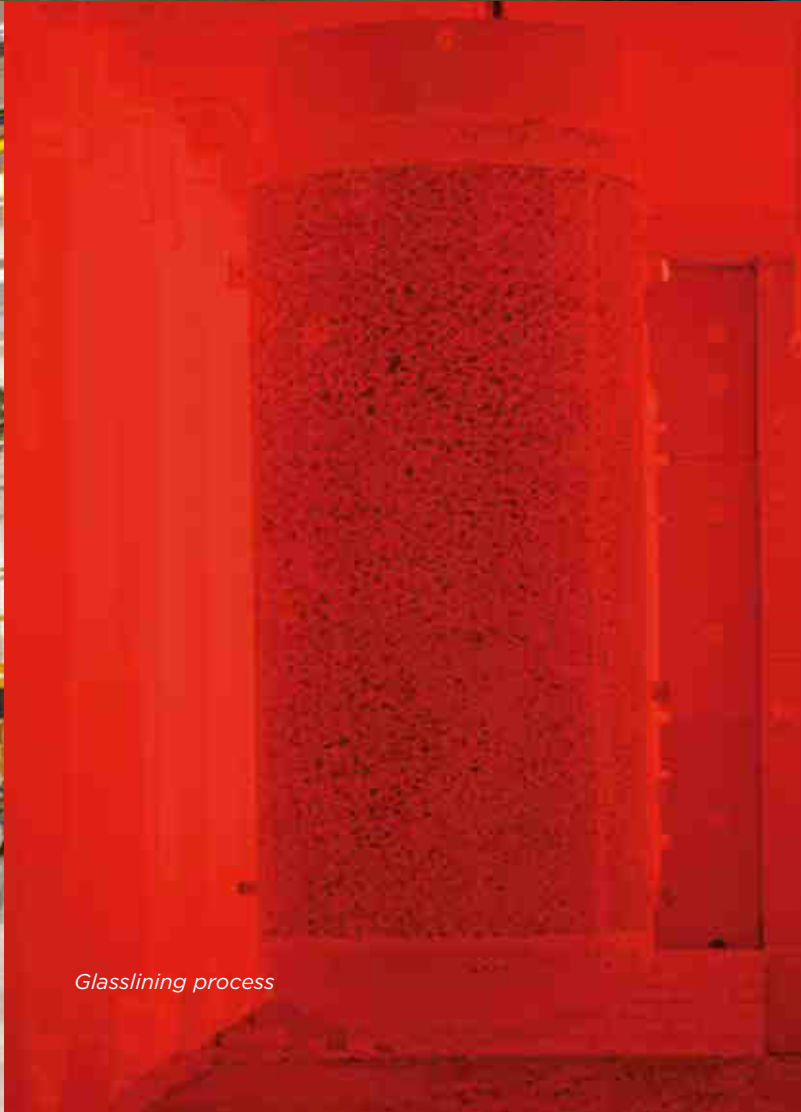

Glasslining process



BSH

GLASSLINED CYLINDER

WITH FIXED HEAT EXCHANGER FOR SANITARY HOT WATER, WALL MOUNTING (100 - 300 LITRES)

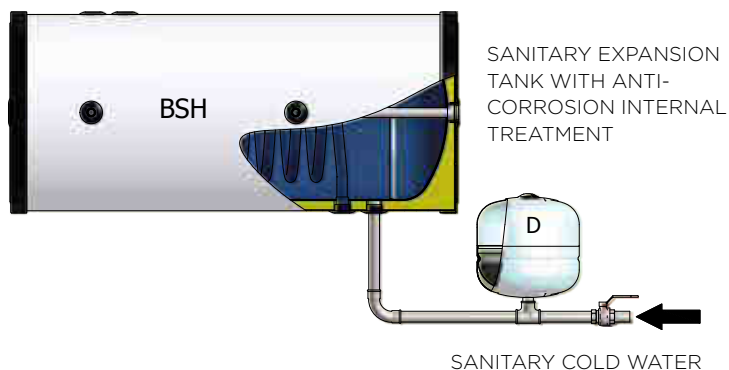

BSH 100 - 150 - 200 - 300

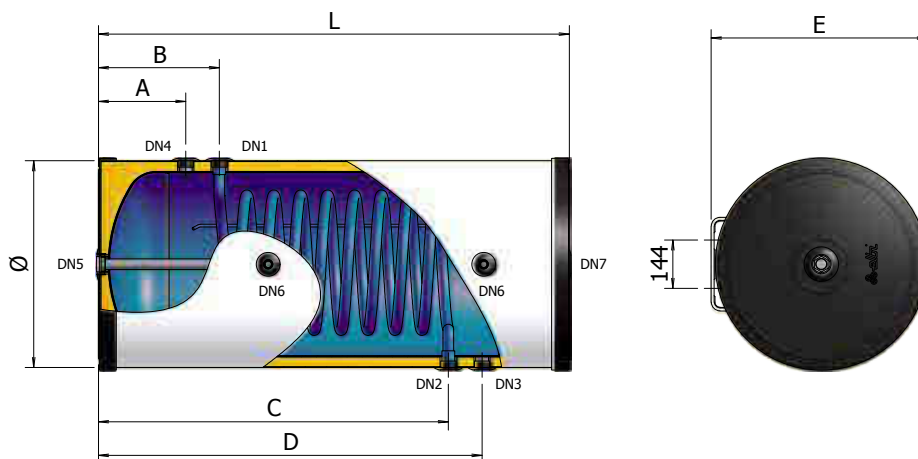

KEYWORD

DN1: Primary fluid inlet, heat exchanger side; **DN2:** Primary fluid outlet, heat exchanger side; **DN3:** Sanitary cold water inlet; **DN4:** Sanitary hot water outlet; **DN5:** Magnesium anode; **DN6:** Probe (Thermometer, Thermostat); **DN7:** Service connection.

CYLINDER

FOR SANITARY HOT WATER

SUITABLE FOR SOLAR SYSTEMS

MAGNESIUM ANODE

INTERNAL ANTI-CORROSION GLASSLINING TREATMENT

POLYURETHANE INSULATION

+ 95°C
CYLINDER
MAX TEMPERATURE

+ 110°C
EXCHANGER
MAX TEMPERATURE

P_{MAX} 10 bar
MAX WORKING PRESSURE

P_{SCA} 12 bar
HEAT EXCHANGER
MAX PRESSURE

REFERENCE STANDARDS

CYLINDER:

2014/68/UE Directive - ART. 4.3, without CE marking
Standard EN 12897:2016

Designed and built in accordance with the requirements of the 2009/125/EC.

Labeling in accordance with the requirements of the 2010/30/EU.

INTERNAL GLASSLINING:

DIN 4753

The glasslining treatment makes the cylinder suitable to contain hot water for sanitary use and resistant to corrosive phenomena.

WARRANTY: 5 YEARS

INSULATION:

Expanded polyurethane without CFC and HCFC

HEAT EXCHANGER:

fixed single-tube coil

INSTALLATION:

- traditional boilers (wall-hung and/or floor-standing)
- condensing boilers
- solar thermal systems

WALL MOUNTING in vertical or horizontal position.

Wall mounting brackets applied.

DIMENSIONS

MODEL	CODE	ENERGY LABEL	HEAT EXCHANGER				L	A	B	C	D	E	NOTES
			CL	LITRES	m ²	LITRES							
BSH-100	A3B0L38 PGP30	C	100	0,40	3	460	885	175	265	625	715	495	
BSH-150	A3B0L43 PGP30	C	150	0,60	4	560	935	230	310	630	630	595	
BSH-200	A3B0L47 PGP30	C	200	0,80	5	560	1155	230	310	850	850	595	
BSH-300	A3B0L51 PGP30	D	300	1,05	7	610	1400	260	360	1040	1140	645	

MODEL	ANODE Ø x Ø conn. x L	DN1	DN2	DN3	DN4	DN5	DN6	DN7
BSH-100	32 x 1.1/4" x 150	1"	1"	1"	1"	1.1/4"	1/2"	1.1/4"
BSH-150	32 x 1.1/4" x 200	1"	1"	1"	1"	1.1/4"	1/2"	1.1/4"
BSH-200	32 x 1.1/4" x 200	1"	1"	1"	1"	1.1/4"	1/2"	1.1/4"
BSH-300	32 x 1.1/4" x 320	1"	1"	1"	1"	1.1/4"	1/2"	1.1/4"

TECHNICAL FEATURES

MODEL	MAX WORKING PRESSURE CYLINDER (Secondary circuit)	MAX. WORKING PRESSURE HEAT EXCHANGER (Primary circuit)	HEAT EXCHANGER PRESSURE DROP			
BSH 100	10 bar	12 bar	5 mbar			
BSH 150			15 mbar			
BSH 200			30 mbar			
BSH 300			75 mbar			

MODEL	INSULATION TYPE	INSULATION THICKNESS	INSULATION DENSITY	INITIAL THERMAL CONDUCTIVITY	(*) INSULATION THERMAL LOSS	EXTERNAL COVER
BSH 100	95% closed cells rigid expanded polyurethane, CFC - HCFC free	30 mm	40 kg/m ³	23,5 mW/m K	1,512 kWh / 24h	Grey polystyrene RAL 9006
BSH 150					1,824 kWh / 24h	
BSH 200					1,896 kWh / 24h	
BSH 300					2,712 kWh / 24h	

(*) Thermal loss calculated with an accumulation temperature equal to 65 °C and with an external temperature equal to 20 °C.

SAFETY DEVICES

The cylinders must be protected from the effects of over pressure by installing:

- A **SAFETY VALVE** calibrated to a pressure lower than the max. pressure of the cylinder;
- A **SANITARY EXPANSION TANK** model ELBI **D - DV series**

MODEL	RECOMMENDED SANITARY EXPANSION TANK (mod. ELBI D-DV series)
BSH 100	D - 8
BSH 150	D - 11
BSH 200	D - 18
BSH 300	D - 24

Tank sized using the following parameters:

T. accumulation= 85 °C / T. inlet = 15 °C / Pre-charge pressure = 3 bar / Max pressure = 6 bar

The recommended capacity must be verified on the basis of the actual dimensions of the system implemented.

MODEL	MAGNESIUM ANODE SUPPLIED	CATHODIC PROTECTION APPLICABLE
BSH-100	1.1/4" x 150 / Cod. 8560000	Cathodic protection with cylinders 100/300 l. Code 8560170
BSH-150	1.1/4" x 200 / Cod. 8560010	
BSH-200	1.1/4" x 200 / Cod. 8560010	
BSH-300	1.1/4" x 320 / Cod. 8560040	

ACCUMULATION AT 60 °C

HEAT EXCHANGER: T. inlet = 80°C; ΔT = 10°C.

STORAGE WATER HEATER: T. inlet =15°C; T. accumulation= 60°C.

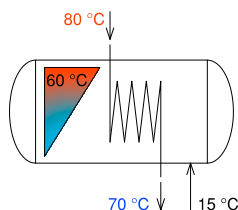

MODEL CYLINDER	THERMAL POWER [kW]	PUMP CAPACITY [l/hour]	HEATING TIME [min] ⁽¹⁾	PRODUCTION DHW AT 60°C [l/hour]	QUANTITY DHW AT 45°C FOR FIRST 10 min. ⁽²⁾ [l]
BSH 100	9,15	807	33	175	105
BSH 150	15,00	1320	37	287	176
BSH 200	19,50	1720	34	373	224
BSH 300	25,90	2290	34	495	300

(1) Time required to bring cylinder temperature from 15 °C to 60 °C

(2) Quantity of DHW (Sanitary Hot Water) at 45°C available in first 10 minutes with accumulation of DHW at 60° C

ACCUMULATION AT 45 °C

HEAT EXCHANGER: T.inlet = 80°C; ΔT = 10°C.

STORAGE WATER HEATER: T.inlet =15°C; T.accumulation= 45°C.

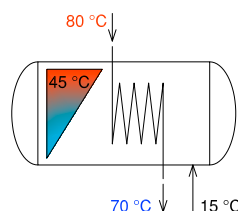

MODEL CYLINDER	THERMAL POWER [kW]	PUMP CAPACITY [l/hour]	HEATING TIME [min] ⁽¹⁾	PRODUCTION DHW AT 45°C [l/hour]
BSH 100	12,00	1060	17	344
BSH 150	18,70	1650	20	536
BSH 200	25,00	2200	18	715
BSH 300	33,00	2900	18	945

(1) Time required to bring cylinder temperature from 15 °C to 45 °C

TABLE OF HEATING ELEMENT APPLICABILITY TO CYLINDERS

Heating element model*					Water heating time from 15° C to 60 °C (expressed in minutes) / The heating times outlined are approximate			
CODE	Power (kW)	Voltage (Volt)	Connection	Length mm	BSH-100	BSH-150	BSH-200	BSH-300
8601000	1	220 V / MF	G 1.1/4"	295	320 min.	480 min.	640 min.	960 min.
8601650	1.65	220 V / MF	G 1.1/4"	450	200 min.	290 min.	390 min.	580 min.
8602000	2	220 V / MF	G 1.1/4"	515	165 min.	240 min.	320 min.	480 min.
8602600	2.6	220 V / MF	G 1.1/4"	675	n.a.	190 min.	250 min.	370 min.
8602601	2.6	220 V / MF	G 1.1/4"	360	130 min.	190 min.	250 min.	370 min.
8603300	3.3	220 V / MF	G 1.1/4"	825	n.a.	n.a.	190 min.	290 min.
8603301	3.3	220 V / MF	G 1.1/4"	435	100 min.	150 min.	190 min.	290 min.
8604001	4	220 V / MF	G 1.1/4"	510	85 min.	120 min.	160 min.	240 min.

n.a.= Heating element not applicable

* In the BSH model heating element must be assembled only with the tank installed in horizontal position.

HYDRAULIC DIAGRAM 1 (BSH IN HORIZONTAL POSITION)

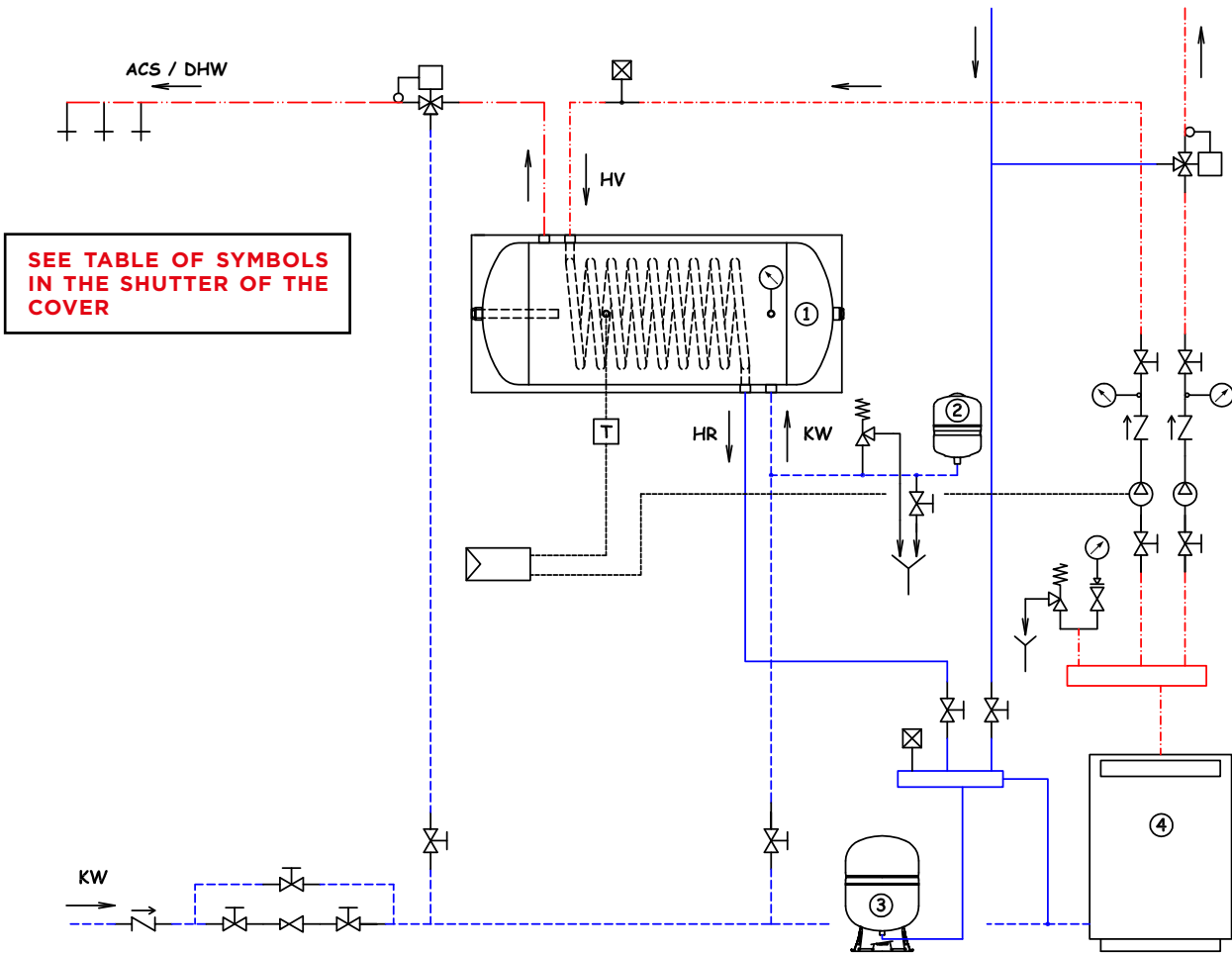

HYDRAULIC DIAGRAM 2 (BSH IN VERTICAL POSITION)

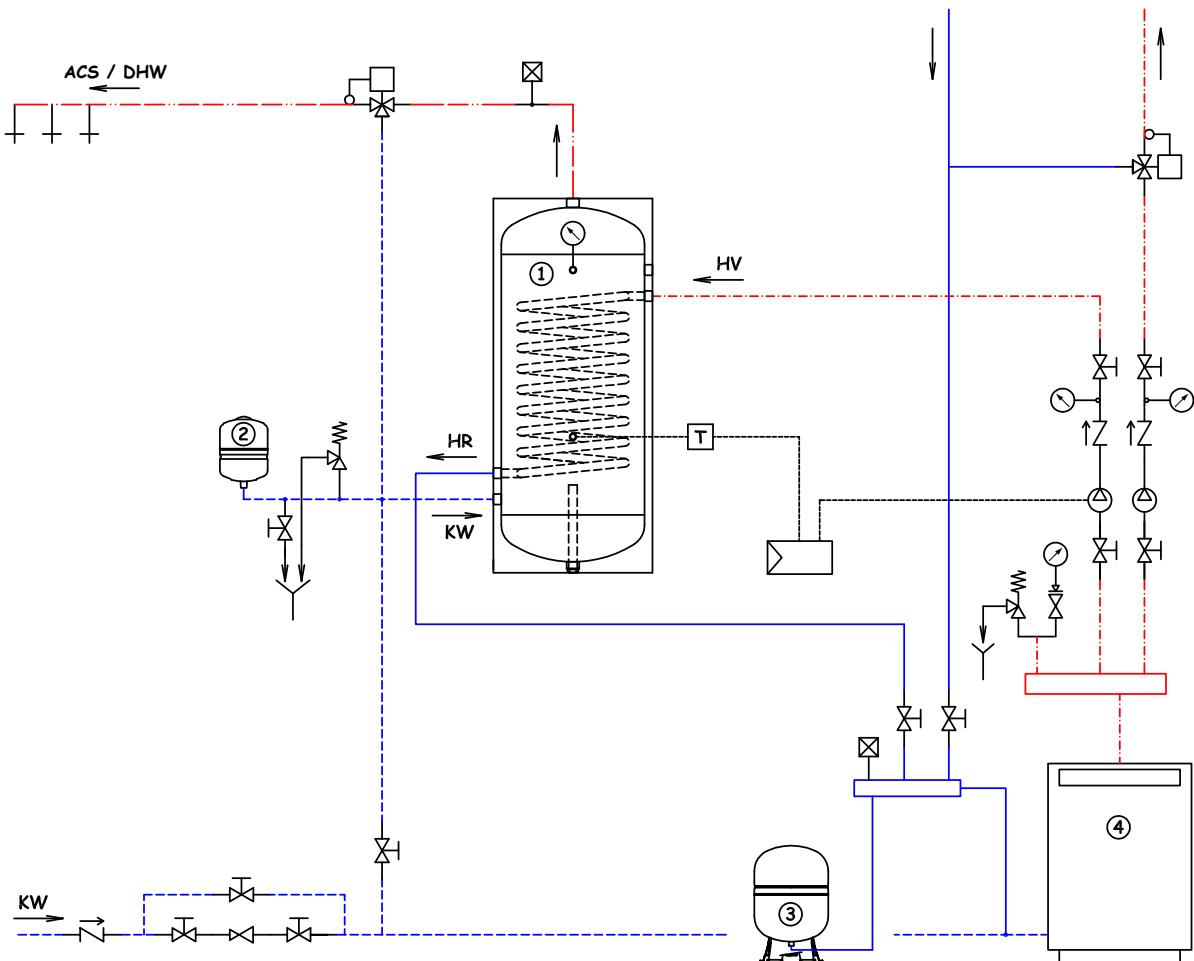



BSV

GLASSLINED CYLINDER

WITH FIXED HEAT EXCHANGER FOR SANITARY HOT WATER (150 - 2000 LITRES)

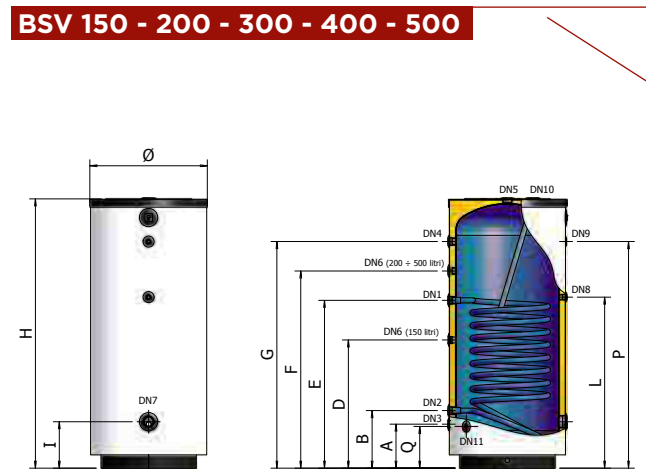
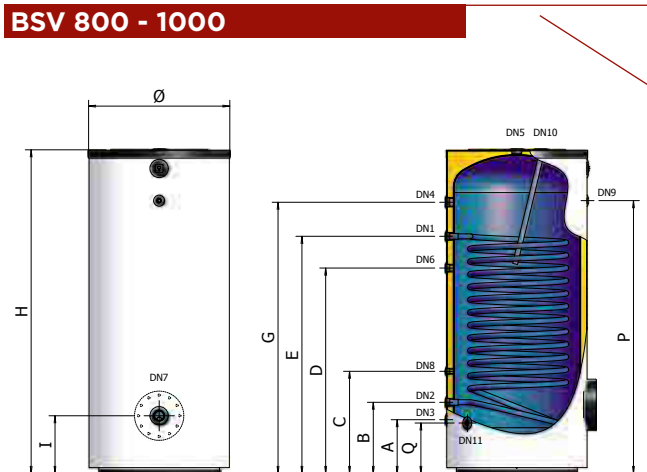
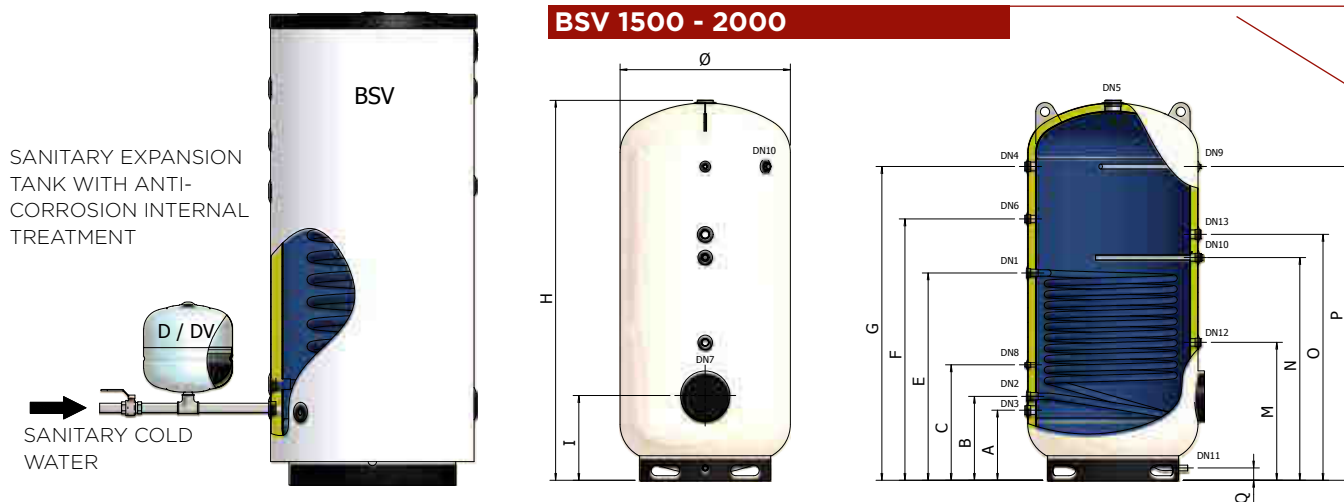

KEYWORD

DN1: Primary fluid inlet, heat exchanger side; **DN2:** Primary fluid outlet, heat exchanger side; **DN3:** Sanitary cold water inlet; **DN4:** Sanitary hot water outlet; **DN5:** Sanitary hot water outlet; **DN6:** Recirculation; **DN7:** Heating element/Visual indicator light; **DN8:** Probe; **DN9:** Thermometer; **DN10:** Magnesium anode; **DN11:** Drain; **DN12:** Sanitary expansion tank; **DN13:** Heating element (only BSV 1500-BSV 2000)

- CYLINDER
- FOR SANITARY HOT WATER
- SUITABLE FOR SOLAR SYSTEMS
- ANODE WITH TESTER (150 - 1000)
- 2 MAGNESIUM ANODES (1500 - 2000)
- INTERNAL, ANTI-CORROSIVE GLASSLINING PROCESS
- POLYURETHANE INSULATION
- + 95°C CYLINDER MAX TEMPERATURE
- + 110°C EXCHANGER MAX TEMPERATURE
- P_{MAX}** 10 bar (150 - 1000) MAX WORKING PRESSURE
- P_{MAX}** 6 bar (1500 - 2000) MAX WORKING PRESSURE
- P_{SCA}** 12 bar HEAT EXCHANGER MAX PRESSURE

WARRANTY: 5 YEARS

INSULATION:

Expanded polyurethane without CFC and HCFC

HEAT EXCHANGER:

fixed single-tube coil

REFERENCE STANDARDS

CYLINDER:

2014/68/UE Directive - ART. 4.3, without CE marking
Standard EN 12897:2016

Designed and built in accordance with the requirements of the 2009/125/EC.

Labeling in accordance with the requirements of the 2010/30/EU.

INTERNAL GLASSLINING



DIN 4753

The glasslining treatment makes the cylinder suitable to contain hot water for sanitary and hygienic use and resistant to corrosive phenomena.

INSTALLATION:

- traditional boilers (wall-hung and/or floor-standing)
- condensing boilers
- solar thermal systems

DIMENSIONS

MODEL	CODE	ENERGY LABEL 	HEAT EXCHANGER  					NOTES
			LITRES	m ²	LITRES	mm	mm	
BSV-150	A3A0L43 PGP40	C	150	0,60	4	600	950	
BSV-200	A3A0L47 PGP40	C	200	0,70	5	600	1170	
BSV-300	A3A0L51 PGP40	C	300	1,05	7	650	1395	
BSV-400	A3A0L53 PGP40	D	400	1,20	8	750	1445	
BSV-500	A3A0L55 PGP40	D	500	1,45	9	750	1695	
BSV-800	A3A0L60 PGP40	/	800	2,00	13	900	1795	
BSV-1000	A3A0L62 PGP40	/	1000	2,40	15	900	2045	
BSV-800+FL.*	A3A1L60 SWS50	/	800	2,00	13	900	1795	
BSV-1000+FL.*	A3A1L62 SWS50	/	1000	2,40	15	900	2045	
BSV-1500+FL.*	A3A1H67 VW050	/	1500	3,60	36	1100	2465	
BSV-2000+FL.*	A3A1H70 VW050	/	2000	4,30	43	1200	2445	

*Flange Version

MODEL	A mm	B mm	C mm	D mm	E mm	F mm	G mm	I mm	L mm	P mm	Q mm
BSV-150	220	300	/	485	715	/	765	250	465	685	220
BSV-200	235	320	/	/	670	765	935	275	785	935	220
BSV-300	255	340	/	/	955	1055	1155	270	955	1155	240
BSV-400	280	365	/	/	900	1040	1180	295	980	1180	265
BSV-500	280	365	/	/	1060	1245	1430	295	1080	1430	265
BSV-800	340	450	635	995	1195	/	1470	365	/	1470	320
BSV-1000	340	450	645	1295	1495	/	1710	435	/	1720	320
BSV-800+FL.	340	450	635	995	1195	/	1470	435	/	1470	320
BSV-1000+FL.	340	450	645	1295	1495	/	1710	435	/	1720	320
BSV-1500+FL.	455	545	750	/	1345	1695	2035	550	/	2035	80
BSV-2000+FL.	445	535	760	/	1425	1685	2025	540	/	2025	80

MODEL	ANODE Ø x Ø conn. x L	DN1	DN2	DN3	DN4	DN5	DN6	DN7	DN8	DN9	DN10	DN11
		BSV-150	32 x 1.1/4" x 350	1"	1"	1"	1"	1.1/4"	3/4"	2"	1/2"	1/2"
BSV-200	32 x 1.1/4" x 350	1"	1"	1"	1"	1.1/4"	3/4"	2"	1/2"	1/2"	1.1/4"	1/2"
BSV-300	32 x 1.1/4" x 550	1"	1"	1"	1"	1.1/4"	3/4"	2"	1/2"	1/2"	1.1/4"	1/2"
BSV-400	32 x 1.1/4" x 550	1"	1"	1"	1"	1.1/4"	3/4"	2"	1/2"	1/2"	1.1/4"	1/2"
BSV-500	32 x 1.1/4" x 700	1"	1"	1"	1"	1.1/4"	3/4"	2"	1/2"	1/2"	1.1/4"	1/2"
BSV-800	32 x 1.1/4" x 700	1.1/4"	1.1/4"	1"	1.1/4"	1.1/4"	1"	2"	1/2"	1/2"	1.1/4"	3/4"
BSV-1000	32 x 1.1/4" x 700	1.1/4"	1.1/4"	1"	1.1/4"	1.1/4"	1"	2"	1/2"	1/2"	1.1/4"	3/4"
BSV-800+FL.	32 x 1.1/4" x 700	1.1/4"	1.1/4"	1"	1.1/4"	1.1/4"	1"	Øi 220	1/2"	1/2"	1.1/4"	3/4"
BSV-1000+FL.	32 x 1.1/4" x 700	1.1/4"	1.1/4"	1"	1.1/4"	1.1/4"	1"	Øi 220	1/2"	1/2"	1.1/4"	3/4"
BSV-1500+FL.*	32 x 1.1/4" x 670	1.1/4"	1.1/4"	1.1/2"	1.1/2"	3"	1.1/4"	Øi 220	1/2"	1/2"	1.1/4"	1"
BSV-2000+FL.*	32 x 1.1/4" x 670	1.1/4"	1.1/4"	1.1/2"	1.1/2"	3"	1.1/4"	Øi 220	1/2"	1/2"	1.1/4"	1"

*2 Anodes

MODEL	M mm	N mm	O mm	DN 12	DN 13
BSV-1500+FL.	895	1445	1595	1.1/4"	1.1/2"
BSV-2000+FL.	885	1475	1605	1.1/4"	1.1/2"

TECHNICAL CHARACTERISTICS

MODEL	MAX WORKING PRESSURE CYLINDER (Secondary circuit)	MAX. WORKING PRESSURE HEAT EXCHANGER (Primary circuit)	HEAT EXCHANGER PRESSURE DROP
BSV 150	10 bar	12 bar	15 mbar
BSV 200			30 mbar
BSV 300			65 mbar
BSV 400			85 mbar
BSV 500			140 mbar
BSV 800			55 mbar
BSV 1000			90 mbar
BSV 1500	6 bar		265 mbar
BSV 2000			425 mbar

MODEL	INSULATION TYPE	INSULATION THICKNESS	INSULATION DENSITY	INITIAL THERMAL CONDUCTIVITY	(*) INSULATION THERMAL LOSS	EXTERNAL COVER
BSV 150	95% closed cells rigid expanded polyurethane, CFC - HCFC free	50 mm	40 kg/m ³	23,5 mW/m K	1,752 kWh / 24h	Grey polystyrene RAL 9006
BSV 200					1,992 kWh / 24h	
BSV 300					2,208 kWh / 24h	
BSV 400					2,856 kWh / 24h	
BSV 500					3,192 kWh / 24h	
BSV 800					3,958 kWh / 24h	
BSV 1000					4,449 kWh / 24h	
BSV 1500	Open cells flexible expanded polyurethane	50 mm	15 kg/m ³	39,0 mW/m K	9,969 kWh / 24h	Skay white RAL 9001
BSV 2000					10,865 kWh / 24h	

(*) Thermal loss calculated with an accumulation temperature equal to 65 °C and with an external temperature equal to 20 °C.

STANDARD EQUIPMENT

- Anode tester

SAFETY DEVICES

The cylinders must be protected from the effects of over pressure by installing:

- **SAFETY VALVE** calibrated to pressure lower than the max. cylinder pressure
- **SANITARY EXPANSION TANK** mod. ELBI **D - DV** series

MODEL	RECOMMENDED SANITARY EXPANSION TANK (mod. ELBI D-DV series)
BSV 150	D - 11
BSV 200	D - 18
BSV 300	D - 24
BSV 400	D - 35
BSV 500	D - 35
BSV 800	DV - 50
BSV 1000	DV - 80
BSV 1500	DV - 150
BSV 2000	DV - 150

Dimensioning carried out with the following parameters: T. accumulation = 85 °C / T. inlet = 15 °C / P. pre-charge = 3 bar / P. max = 6 bar
The recommended capacities must be verified on the basis of the actual dimensions of the system implemented.

MODEL	MAGNESIUM ANODE SUPPLIED	CATHODIC PROTECTION APPLICABLE
BSV 150	1,1/4" x 350 / Cod.8560046	Cathodic protection for cylinders 100/400 l. Code 8560170
BSV 200	1,1/4" x 350 / Cod.8560046	
BSV 300	1,1/4" x 550 / Cod.8560066	
BSV 400	1,1/4" x 550 / Cod.8560066	
BSV 500	1,1/4" x 700 / Cod.8560086	Cathodic protection for cylinders 500/1000 l. Code 8560175
BSV 800	1,1/4" x 700 / Cod.8560086	
BSV 1000	1,1/4" x 700 / Cod.8560086	
BSV 1500	n.2 x 1,1/4" x 670 / Cod. 8560070	Cathodic protection for cylinders 1500/2500 l. Code 8560180
BSV 2000	n.2 x 1,1/4" x 670 / Cod. 8560070	

ACCUMULATION AT 60 °C

HEAT EXCHANGER: T. inlet = 80°C; ΔT = 10°C.

STORAGE WATER HEATER: T. inlet =15°C; T. accumulation= 60°C.

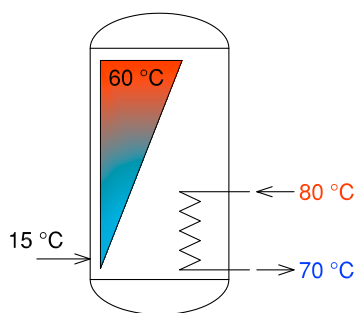

MODEL CYLINDER	THERMAL POWER [kW]	PUMP CAPACITY [l/hour]	HEATING TIME ⁽¹⁾ [min]	PRODUCTION DHW AT 60°C [l/hour]	QUANTITY DHW AT 45°C FOR FIRST 10 min. ⁽²⁾ [l]
BSV 150	15,00	1320	37	287	176
BSV 200	19,50	1720	34	373	224
BSV 300	25,90	2290	34	495	300
BSV 400	29,00	2500	45	554	375
BSV 500	33,00	2900	47	630	449
BSV 800	50,00	4400	49	955	668
BSV 1000	60,00	5300	47	1140	770
BSV 1500	79,00	6900	60	1500	1040
BSV 2000	93,00	8200	67	1800	1300

(1) Time required to bring the temperature of the cylinder from 15 °C to 60 °C

(2) Quantity of DHW (Sanitary Hot Water) at 45°C available in first 10 minutes with accumulation of DHW at 60° C.

ACCUMULATION AT 45 °C

HEAT EXCHANGER: T.inlet = 80°C; ΔT = 10°C.

STORAGE WATER HEATER: T.inlet =15°C; T.accumulation= 45°C

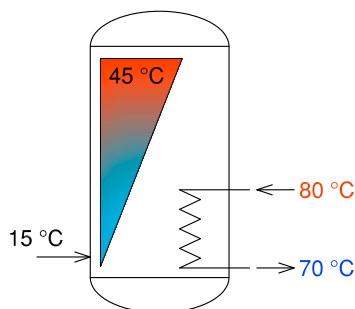

MODEL CYLINDER	THERMAL POWER [kW]	PUMP CAPACITY [l/hour]	HEATING TIME ⁽¹⁾ [min]	PRODUCTION DHW AT 45°C [l/hour]
BSV 150	18,80	1650	20	536
BSV 200	25,00	2200	18	715
BSV 300	33,00	2900	18	945
BSV 400	36,00	3170	24	1030
BSV 500	43,00	3800	24	1230
BSV 800	59,50	5200	28	1700
BSV 1000	68,50	6000	27	1960
BSV 1500	95,00	8300	33	2700
BSV 2000	112,00	9850	37	3200

(1) Time required to bring cylinder temperature from 15 °C to 45 °C

TABLE OF HEATING ELEMENT APPLICABILITY TO CYLINDERS

Heating element model					Water heating time from 15° C to 60 °C (expressed in minutes) <i>The heating times outlined are approximate</i>								
CODE	Power (kW)	Voltage (Volt)	Connection	Length (mm)	BSV-150	BSV-200	BSV-300	BSV-400	BSV-500	BSV-800	BSV-1000	BSV-1500	BSV-2000
8601000	1	220 V / MF	G 1.1/4"	295	480 min.	630 min.	960 min.	1270 min.	1580 min.	2520 min.	3150 min.	4720 min.	6300 min.
8601650	1.65	220 V / MF	G 1.1/4"	450	285 min.	380 min.	580 min.	770 min.	970 min.	1550 min.	1920 min.	2870 min.	3820 min.
8602000	2	220 V / MF	G 1.1/4"	515	n.a.	n.a.	n.a.	640 min.	800 min.	1270 min.	1580 min.	2370 min.	3150 min.
8602600	2.6	220 V / MF	G 1.1/4"	675	n.a.	n.a.	n.a.	n.a.	n.a.	980 min.	1230 min.	1830 min.	2450 min.
8602601	2.6	220 V / MF	G 1.1/4"	360	180 min.	250 min.	370 min.	490 min.	630 min.	980 min.	1230 min.	1830 min.	2450 min.
8603300	3.3	220 V / MF	G 1.1/4"	825	n.a.	n.a.	n.a.	n.a.	n.a.	n.a.	n.a.	1450 min.	1940 min.
8603301	3.3	220 V / MF	G 1.1/4"	435	145 min.	200 min.	295 min.	390 min.	490 min.	780 min.	980 min.	1450 min.	1940 min.
8604001	4	220 V / MF	G 1.1/4"	510	n.a.	n.a.	n.a.	320 min.	410 min.	640 min.	800 min.	1200 min.	1600 min.
8705000	5	380 V / TF	G 1.1/2"	445	95 min.	140 min.	200 min.	260 min.	330 min.	520 min.	640 min.	950 min.	1300 min.
8706000	6	380 V / TF	G 1.1/2"	510	n.a.	n.a.	n.a.	220 min.	280 min.	430 min.	540 min.	800 min.	1060 min.
8708000	8	380 V / TF	G 1.1/2"	670	n.a.	n.a.	n.a.	n.a.	n.a.	330 min.	420 min.	610 min.	800 min.
8710000	10	380 V / TF	G 1.1/2"	820	n.a.	n.a.	n.a.	n.a.	n.a.	n.a.	n.a.	490 min.	640 min.
8712000	12	380 V / TF	G 1.1/2"	970	n.a.	n.a.	n.a.	n.a.	n.a.	n.a.	n.a.	410 min.	540 min.

n.a.= Heating element not applicable

HYDRAULIC DIAGRAM 1 (BSV CYLINDER WITH BOILER)

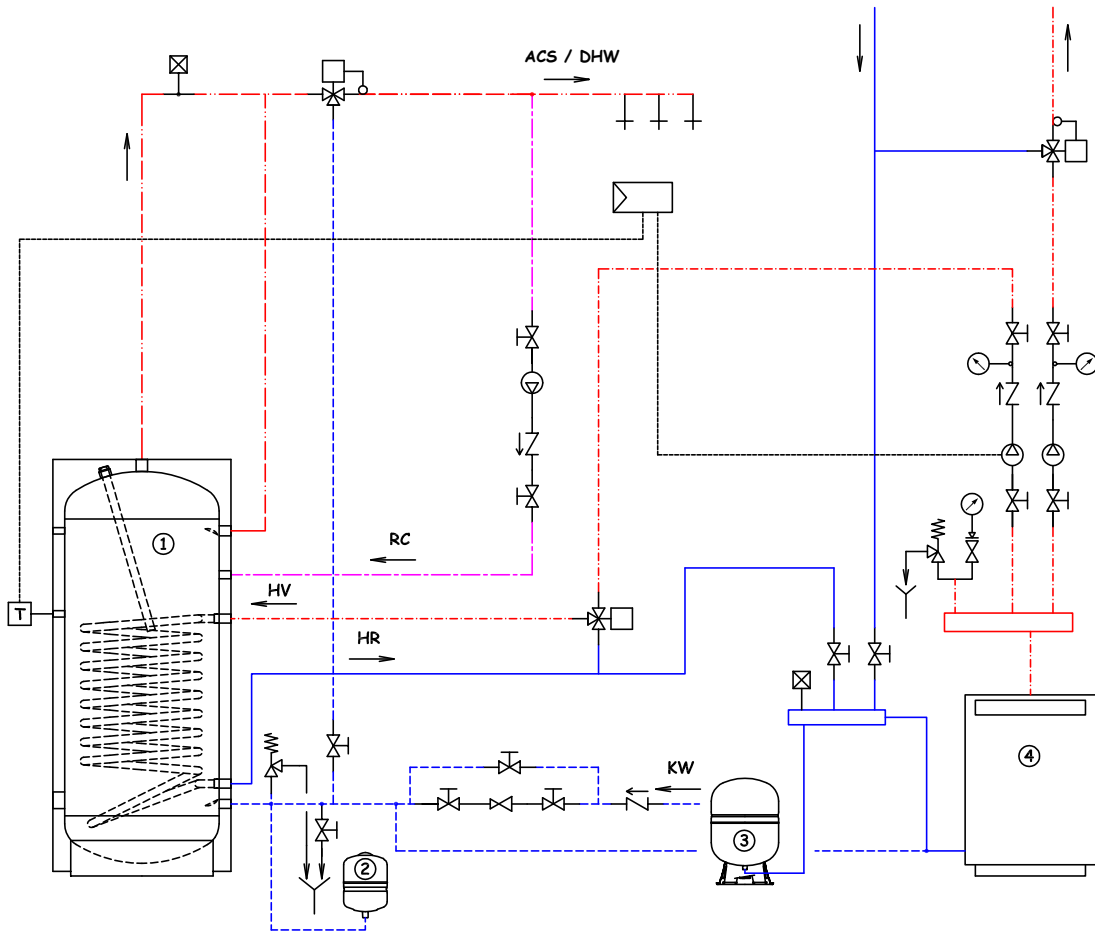

HYDRAULIC DIAGRAM 2 (BSV CYLINDER WITH SOLAR)

SEE TABLE OF SYMBOLS
IN THE SHUTTER OF THE
COVER

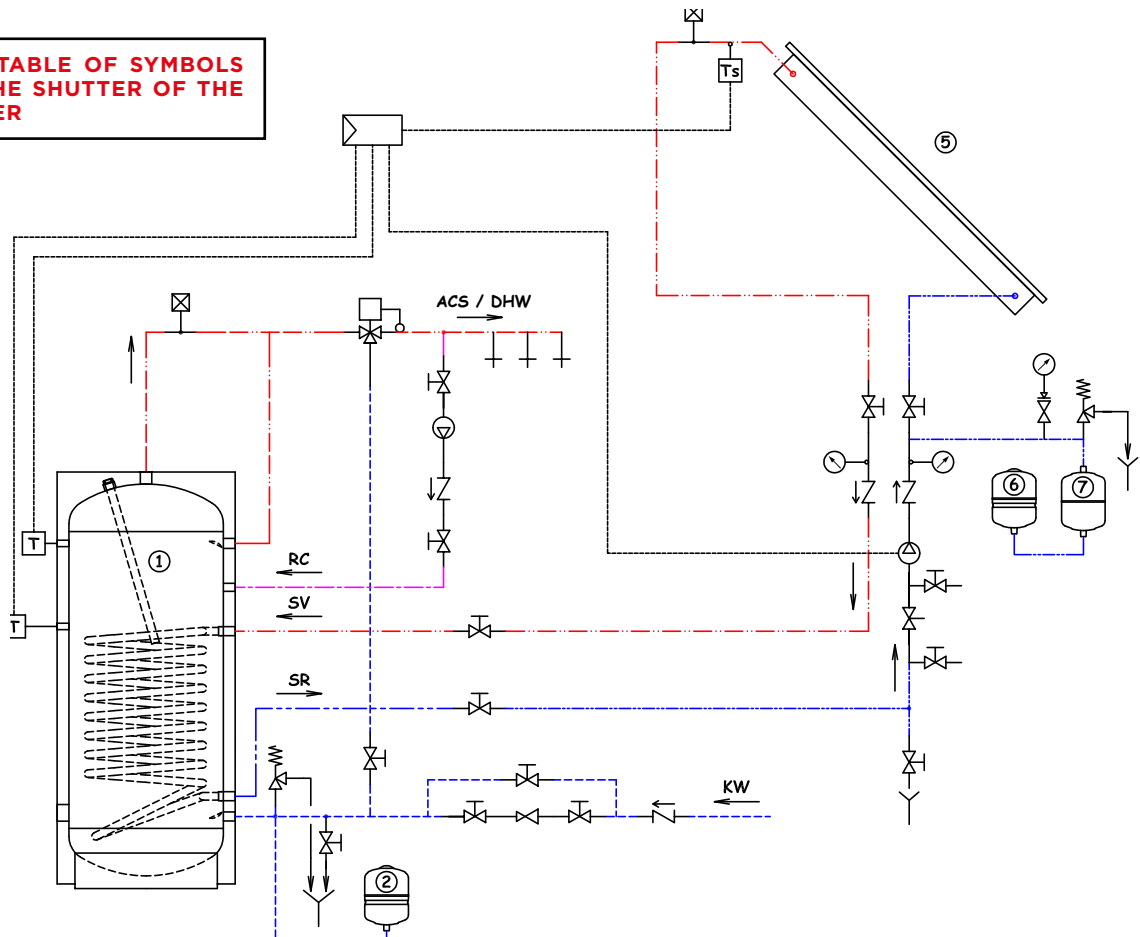

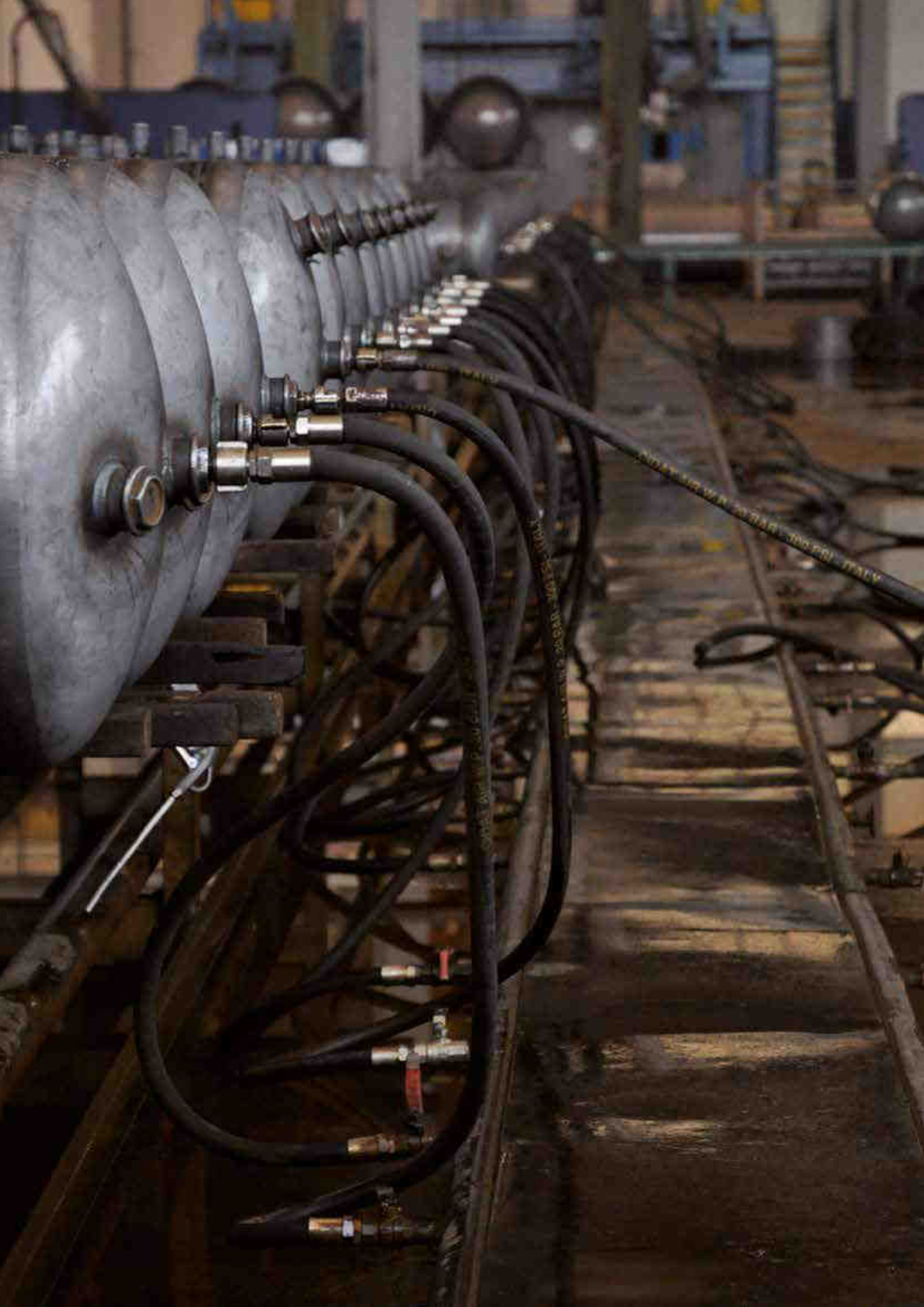



BSP

GLASSLINED DHW CYLINDER WITH FIXED EXCHANGER

FOR HEAT PUMPS (300 - 1000 LITRES)

BSP 300-1000

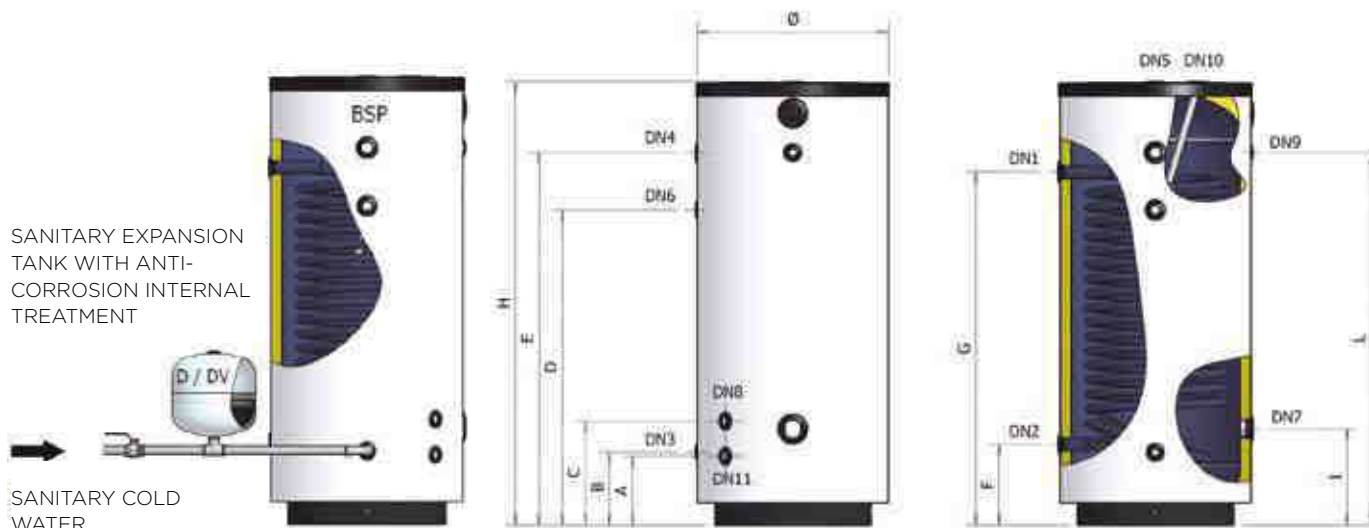

KEYWORD

DN1: Primary fluid inlet, heat exchanger side; **DN2:** Primary fluid outlet, heat exchanger side; **DN3:** Sanitary cold water inlet; **DN4:** Sanitary hot water outlet; **DN5:** Sanitary hot water outlet; **DN6:** Recirculation; **DN7:** Heating element/Visual indicator light; **DN8:** Probe; **DN9:** Thermometer; **DN10:** Magnesium anode; **DN11:** Drain; **DN12:** Sanitary expansion tank; **DN13:** Heating element (only BSV 1500-BSV 2000)

CYLINDER

FOR SANITARY HOT WATER

SUITABLE FOR HEATING PUMP

ANODE WITH TESTER (150 - 1000)

INTERNAL, ANTI-CORROSIVE GLASSLINING PROCESS

POLYURETHANE INSULATION

+ 95°C
CYLINDER
MAX TEMPERATURE

+ 110°C
EXCHANGER
MAX TEMPERATURE

P_{MAX} 10 bar
CYLINDER
MAX WORKING PRESSURE

P_{SCA} 12 bar
HEAT EXCHANGER
MAX PRESSURE

REFERENCE STANDARDS

CYLINDER:

2014/68/UE Directive - ART. 4.3, without CE marking

INTERNAL GLASSLINING

DIN 4753

The glasslining treatment makes the cylinder suitable to contain hot water for sanitary and hygienic use and resistant to corrosive phenomena.

WARRANTY: 5 YEARS

INSULATION:

Expanded polyurethane without CFC and HCFC

HEAT EXCHANGER:

fixed single-tube coil

INSTALLATION:

· heat pumps

DIMENSIONS

MODEL	CODE	ENERGY LABEL	HEAT EXCHANGER								NOTES
		CLASS	LITRES	m ²	LITRES	mm	mm	DN1	DN2		
BSP-300	A3TOL51 PGP40	C	300	3,4	21	650	1400	1" 1/4	1" 1/4		
BSP-500	A3TOL55 PGP40	D	500	5,5	35	750	1695	1" 1/4	1" 1/4		
BSP-800	A3TOL60 PGP40	/	800	6,2	39	990	1835	1" 1/4	1" 1/4		
BSP-1000	A3TOL62 PGP40	/	1000	6,2	39	990	2285	1" 1/4	1" 1/4		

MODEL	DN3	DN4	DN5	DN6	DN7	DN8	DN9	DN10	DN11	DN12
BSP-300	1"	1"	1" 1/4	3/4"	2"	1/2"	1/2"	1" 1/4	1/2"	1"
BSP-500	1"	1"	1" 1/4	3/4"	2"	1/2"	1/2"	1" 1/4	1/2"	1"
BSP-800	1" 1/4	1" 1/4	1" 1/4	1"	2"	1/2"	1/2"	1" 1/4	3/4"	1"
BSP-1000	1" 1/4	1" 1/4	1" 1/4	1"	2"	1/2"	1/2"	1" 1/4	3/4"	1"

MODEL	A mm	B mm	C mm	D mm	E mm	F mm	G mm	I mm	L mm
BSP-300	245	260	380	995	1160	290	1115	350	1160
BSP-500	265	280	400	1210	1430	310	1355	370	1430
BSP-800	315	330	450	1270	1480	360	1240	420	1480
BSP-1000	315	330	450	1450	1730	360	1240	420	1730

TECHNICAL CHARACTERISTICS

MODEL	CYLINDER		HEAT EXCHANGER	
	MAX WORKING PRESSURE	MAX WORKING TEMPERATURE	MAX WORKING PRESSURE	MAX WORKING TEMPERATURE
BSP-300	10 bar	95 °C	12 bar	110 °C
BSP-500				
BSP-800				
BSP-1000				

MODEL	INSULATION TYPE	INSULATION THICKNESS	INSULATION DENSITY	INITIAL THERMAL CONDUCTIVITY	(*) INSULATION THERMAL LOSS	EXTERNAL COVER
BSP-300	95% closed cells rigid expanded polyurethane, CFC - HCFC free	50 mm	40 kg/m ³	23,5 mW/m K	2,208 kWh / 24h	Grey polystyrene RAL 9006
BSP-500					3,192 kWh / 24h	
BSP-800					3,958 kWh / 24h	
BSP-1000					4,449 kWh / 24h	

(*) Thermal loss calculated with an accumulation temperature equal to 65 °C and with an external temperature equal to 20 °C.

STANDARD EQUIPMENT

- Anode tester

SAFETY DEVICES

The cylinders must be protected from the effects of over pressure by installing:

- **SAFETY VALVE** calibrated to pressure lower than the max. cylinder pressure
- **SANITARY EXPANSION TANK** mod. ELBI **D - DV** series

MODEL	RECOMMENDED SANITARY EXPANSION TANK (mod. ELBI D-DV series)
BSP-300	D - 24
BSP-500	D - 35
BSP-800	DV - 50
BSP-1000	DV - 80

Dimensioning carried out with the following parameters:

T. accumulation = 85 °C / T. inlet = 15 °C / P. pre-charge = 3 bar / P. max = 6 bar

The recommended capacities must be verified on the basis of the actual dimensions of the system implemented.

MODEL	MAGNESIUM ANODE SUPPLIED	CATHODIC PROTECTION APPLICABLE
BSP-300	1,1/4" x 550 / Cod. 8560066	Cathodic protection for cylinders 100/400 l. Code 8560170
BSP-500		
BSP-800	1,1/4" x 700 / Cod. 8560086	Cathodic protection for cylinders 500/1000 l. Code 8560175
BSP-1000		

ACCUMULATION AT 45 °C

HEAT EXCHANGER: T. inlet = 60°C; ΔT = 10°C.

STORAGE WATER HEATER: T. inlet =15°C; T. accumulation= 45°C.

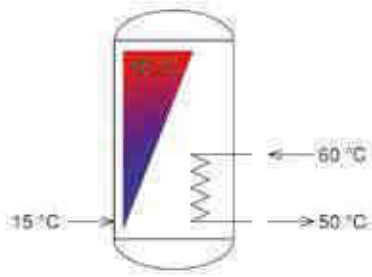

MODEL CYLINDER	THERMAL POWER [kW]	PUMP CAPACITY [l/hour]	HEATING TIME ⁽¹⁾ [min]	PRODUCTION DHW AT 45°C [l/hour]
BSP 300	49,5	4300	13	1420
BSP 500	80	7000	13	2295
BSP 800	90	7910	19	2590
BSP 1000	90	7910	23	2590

(1) Time required to bring the temperature of the cylinder from 15 °C to 45°C

TABLE OF HEATING ELEMENT APPLICABILITY TO CYLINDERS

Heating element model					Water heating time from 15° C to 60 °C (expressed in minutes) <i>The heating times outlined are approximate</i>			
CODE	Power (kW)	Voltage (Volt)	Connection	Length (mm)	BSP-300	BSP-500	BSP-800	BSP-1000
8601000	1	220 V / MF	G 1.1/4"	295	960 min.	1580 min.	2520 min.	3150 min.
8601650	1.65	220 V / MF	G 1.1/4"	450	580 min.	970 min.	1550 min.	1920 min.
8602000	2	220 V / MF	G 1.1/4"	515	n.a.	800 min	1270 min.	1580 min.
8602600	2.6	220 V / MF	G 1.1/4"	675	n.a.	n.a.	980 min.	1230 min.
8602601	2.6	220 V / MF	G 1.1/4"	360	370 min.	630 min.	980 min.	1230 min.
8603300	3.3	220 V / MF	G 1.1/4"	825	n.a.	n.a.	n.a.	n.a.
8603301	3.3	220 V / MF	G 1.1/4"	435	295 min.	490 min.	780 min.	980 min.
8604001	4	220 V / MF	G 1.1/4"	510	n.a.	410 min.	640 min.	800 min.
8705000	5	380 V / TF	G 1.1/2"	445	200 min.	330 min.	520 min.	640 min.
8706000	6	380 V / TF	G 1.1/2"	510	n.a.	280 min.	430 min.	540 min.
8708000	8	380 V / TF	G 1.1/2"	670	n.a.	n.a.	330 min.	420 min.
8710000	10	380 V / TF	G 1.1/2"	820	n.a.	n.a.	n.a.	n.a.
8712000	12	380 V / TF	G 1.1/2"	970	n.a.	n.a.	n.a.	n.a.

SEE TABLE OF SYMBOLS
IN THE SHUTTER OF THE
COVER

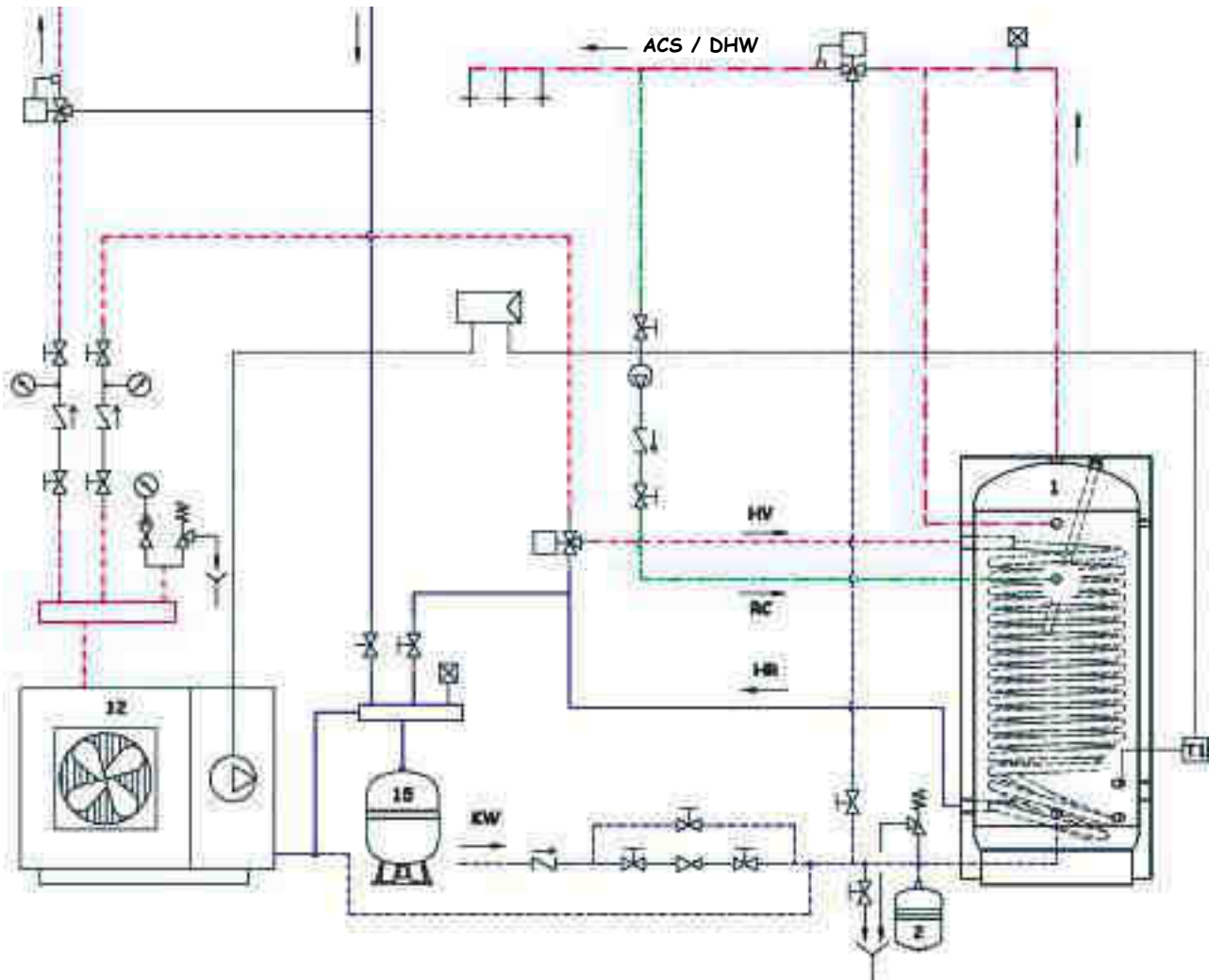



BSM

HIGH PERFORMANCES GLASSLINED CYLINDER

WITH FIXED HEAT EXCHANGER FOR SANITARY HOT WATER (150 - 1000 LITRES)



BSM 150 - 200

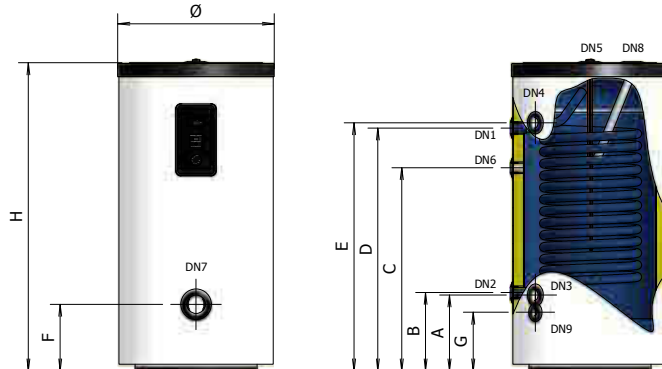

BSM 300 - 1000

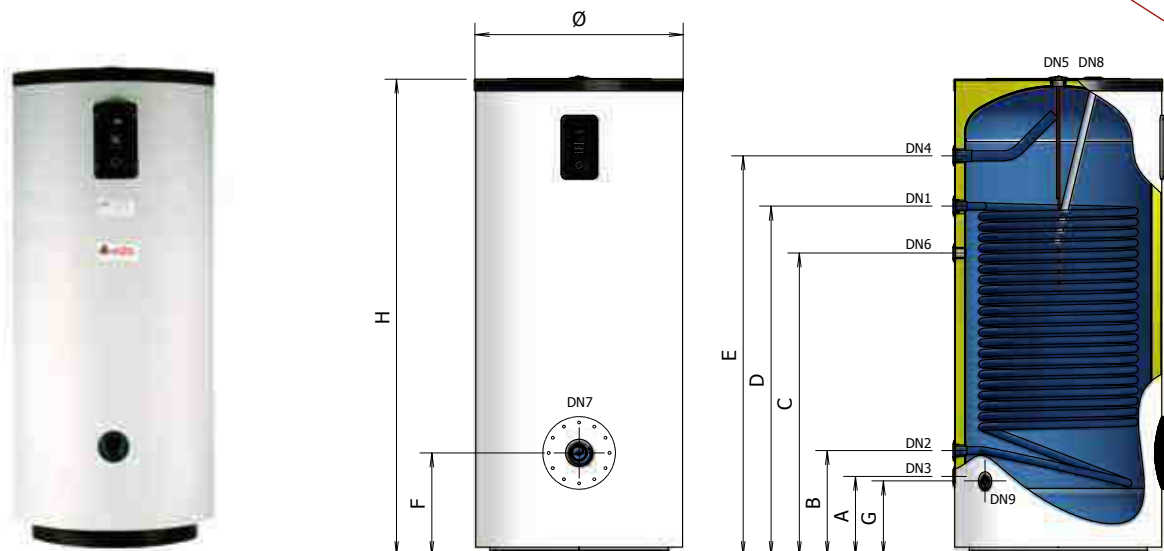

KEYWORD

DN1: Primary fluid inlet, heat exchanger side; **DN2:** Primary fluid outlet, heat exchanger side; **DN3:** Sanitary cold water inlet; **DN4:** Sanitary hot water outlet; **DN5:** Probe (Thermometer, thermostat); **DN6:** Recirculation; **DN7:** Heating element/Visual indicator light; **DN8:** Magnesium anode; **DN9:** Drain

- CYLINDER
- FOR SANITARY HOT WATER
- SUITABLE FOR SOLAR SYSTEMS
- ANODE WITH TESTER
- INTERNAL, ANTI-CORROSION GLASSLINING TREATMENT
- POLYURETHANE INSULATION
- THERMOMETER
- THERMOSTAT

- + 95°C
CYLINDER
MAX TEMPERATURE
- + 110°C
MAX TEMPERATURE OF
EXCHANGER
- P_{MAX}** 10 bar
MAX WORKING PRESSURE
- P_{SCA}** 12 bar
MAX PRESSURE
OF EXCHANGER

WARRANTY: 5 YEARS

REFERENCE STANDARDS

CYLINDER:

2014/68/UE Directive - ART. 4.3, without CE marking
Standard EN 12897:2016

Designed and built in accordance with the requirements of the 2009/125/EC.

Labeling in accordance with the requirements of the 2010/30/EU.

INTERNAL GLASSLINING:

DIN 4753

The glasslining treatment makes the cylinder suitable to contain hot water for sanitary and hygienic use and resistant to corrosive phenomena.

INSULATION:

Expanded polyurethane without CFC and HCFC.



HEAT EXCHANGER:

fixed single tube coil

INSTALLATION:

- traditional boilers (wall-hung and/or floor-standing)
- condensing boilers
- solar thermal systems

DIMENSIONS

MODEL	CODE	ENERGY LABEL		HEAT EXCHANGER 					NOTES
				CL	LITRES	m ²	LITRES		
BSM-150	A3COL43 PGP40	C		150	1,10	7	600	950	
BSM-200	A3COL47 PGP40	C		200	1,60	10	600	1170	
BSM-300	A3COL51 PGP40	C		300	1,90	11	650	1400	
BSM-400	A3COL53 PGP40	D		400	2,10	13	750	1445	
BSM-500	A3COL55 PGP40	D		500	2,70	17	750	1695	
BSM-800	A3COL60 PGP40	/		800	3,50	21	900	1795	
BSM-1000	A3COL62 PGP40	/		1000	4,50	28	900	2045	
BSM-800+FL. (*)	A3C1L60 SWS50	/		800	3,50	21	900	1795	
BSM-1000+FL. (*)	A3C1L62 SWS50	/		1000	4,50	28	900	2045	

(*) Flange version

MODEL	A mm	B mm	C mm	D mm	E mm	F mm	G mm
BSM-150	290	275	590	715	720	250	225
BSM-200	290	300	770	920	940	255	225
BSM-300	260	365	890	1030	1160	310	245
BSM-400	280	385	850	960	1180	330	265
BSM-500	280	385	1000	1140	1430	330	265
BSM-800	340	450	995	1270	1460	440	320
BSM-1000	340	450	1295	1495	1710	440	320
BSM-800+FL.	340	450	995	1270	1460	435	320
BSM-1000+FL.	340	450	1295	1495	1710	435	320

MODEL	ANODE ø x ø conn. x L	DN1	DN2	DN3	DN4	DN5	DN6	DN7	DN8	DN9
BSM-150	32 x 1.1/4" x 350	1"	1"	1"	1"	1"1/4	3/4"	2"	1"1/4	1/2"
BSM-200	32 x 1.1/4" x 350	1"	1"	1"	1"	1"1/4	3/4"	2"	1"1/4	1/2"
BSM-300	32 x 1.1/4" x 550	1"	1"	1"	1"	1"1/4	3/4"	2"	1"1/4	1/2"
BSM-400	32 x 1.1/4" x 550	1"	1"	1"	1"	1"1/4	3/4"	2"	1"1/4	1/2"
BSM-500	32 x 1.1/4" x 700	1"	1"	1"	1"	1"1/4	3/4"	2"	1"1/4	1/2"
BSM-800	32 x 1.1/4" x 700	1"1/4	1"1/4	1"1/4	1"1/4	1"1/4	1"	2"	1"1/4	3/4"
BSM-1000	32 x 1.1/4" x 700	1"1/4	1"1/4	1"1/4	1"1/4	1"1/4	1"	2"	1"1/4	3/4"
BSM-800+FL.	32 x 1.1/4" x 700	1"1/4	1"1/4	1"1/4	1"1/4	1"1/4	1"	Øi 220	1"1/4	3/4"
BSM-1000+FL.	32 x 1.1/4" x 700	1"1/4	1"1/4	1"1/4	1"1/4	1"1/4	1"	Øi 220	1"1/4	3/4"

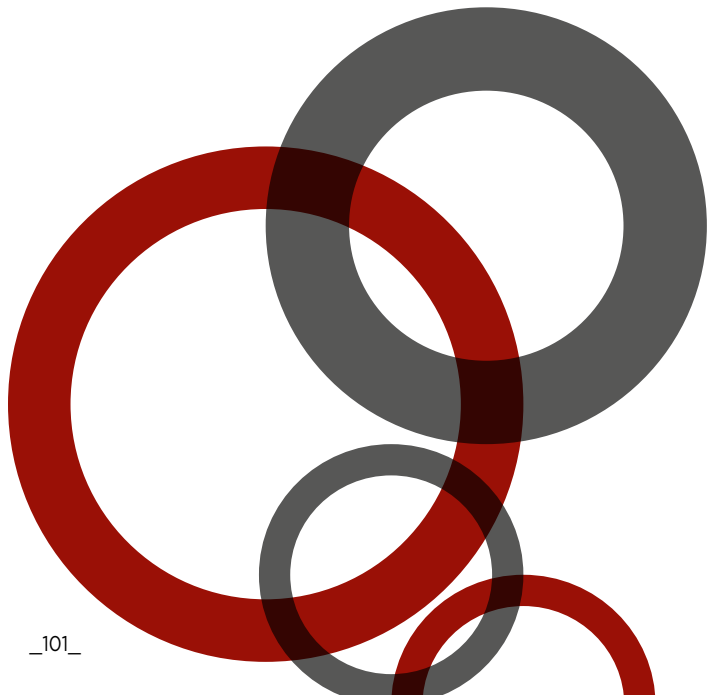

TECHNICAL CHARACTERISTICS

MODEL	MAX WORKING PRESSURE CYLINDER (Secondary circuit)	MAX. WORKING PRESSURE HEAT EXCHANGER (Primary circuit)	HEAT EXCHANGER PRESSURE DROP
BSM 150	10 bar	12 bar	50 mbar
BSM 200			105 mbar
BSM 300			200 mbar
BSM 400			250 mbar
BSM 500			500 mbar
BSM 800			150 mbar
BSM 1000			325 mbar

MODEL	INSULATION TYPE	INSULATION THICKNESS	INSULATION DENSITY	INITIAL THERMAL CONDUCTIVITY	(*) INSULATION THERMAL LOSS	EXTERNAL COVER
BSM 150	95% closed cells rigid expanded polyurethane, CFC - HCFC free	50 mm	40 kg/m ³	23,5 mW/m K	1,752 kWh / 24h	Grey polystyrene RAL 9006
BSM 200					1,992 kWh / 24h	
BSM 300					2,208 kWh / 24h	
BSM 400					2,856 kWh / 24h	
BSM 500					3,192 kWh / 24h	
BSM 800					3,958 kWh / 24h	
BSM 1000					4,449 kWh / 24h	

(*) Thermal loss calculated with an accumulation temperature equal to 65 °C and with an external temperature equal to 20 °C.

STANDARD EQUIPMENT

- Anoder tester
- Thermometer
- Thermostat

SAFETY DEVICES

The cylinders must be protected from the effects of over pressure by installing:

- A **SAFETY VALVE** calibrated to a pressure lower than the max. pressure of the cylinder;
- A **SANITARY EXPANSION TANK** model **ELBI D - DV series**

MODEL	RECOMMENDED SANITARY EXPANSION TANK (mod. ELBI D-DV series)
BSM 150	D - 11
BSM 200	D - 18
BSM 300	D - 24
BSM 400	D - 35
BSM 500	D - 35
BSM 800	DV - 50
BSM 1000	DV - 80

Tank sized using the following parameters: T. accumulation= 85 °C / T. inlet = 15 °C / Pre-charge pressure = 3 bar / Max pressure = 6 bar
The recommended capacity must be verified on the basis of the actual dimensions of the system implemented

MODEL	MAGNESIUM ANODE SUPPLIED	CATHODIC PROTECTION APPLICABLE
BSM 150	1,1/4" x 350 / Cod.8560046	Cathodic protection with cylinders 100/300 l. Code 8560170
BSM 200	1,1/4" x 350 / Cod.8560046	
BSM 300	1,1/4" x 550 / Cod.8560066	
BSM 400	1,1/4" x 550 / Cod.8560066	
BSM 500	1,1/4" x 700 / Cod.8560086	
BSM 800	1,1/4" x 700 / Cod.8560086	Cathodic protection with cylinders 500/1000 l. Code 8560175
BSM 1000	1,1/4" x 700 / Cod.8560086	

THERMAL YIELD

ACCUMULATION AT 60 °C

HEAT EXCHANGER: $T_{inlet} = 80^{\circ}\text{C}$; $\Delta T = 10^{\circ}\text{C}$.

STORAGE WATER HEATER: $T_{inlet} = 15^{\circ}\text{C}$; $T_{accumulation} = 60^{\circ}\text{C}$

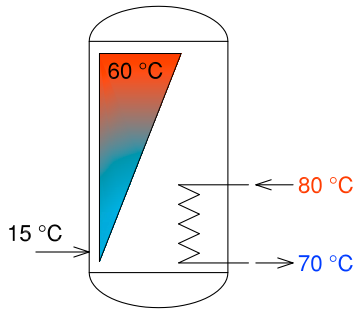

MODEL CYLINDER	THERMAL POWER [kW]	PUMP CAPACITY [l/hour]	HEATING TIME ⁽¹⁾ [min]	PRODUCTION DHW AT 60°C [l/hour]	QUANTITY DHW AT 45°C FOR FIRST 10 min. ⁽²⁾ [l]
BSM 150	22,20	1980	25	425	220
BSM 200	31,90	2800	21	610	265
BSM 300	41,60	3600	21	790	350
BSM 400	44,70	3900	29	860	435
BSM 500	57,40	5000	27	1095	530
BSM 800	70,50	6200	35	1345	750
BSM 1000	93,00	8100	32	1775	940

(1) Time required to bring the temperature of the cylinder from 15 °C to 60 °C

(2) Quantity of DHW (Sanitary Hot Water) at 45°C available in first 10 minutes with accumulation of DHW at 60° C.

ACCUMULATION AT 45 °C

HEAT EXCHANGER: $T_{inlet} = 80^{\circ}\text{C}$; $\Delta T = 10^{\circ}\text{C}$.

STORAGE WATER HEATER: $T_{inlet} = 15^{\circ}\text{C}$; $T_{accumulation} = 45^{\circ}\text{C}$.

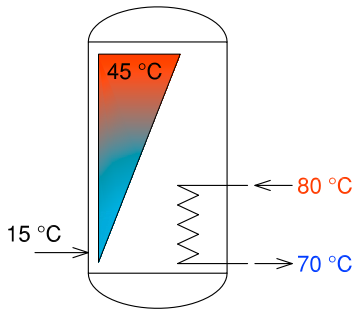

MODEL CYLINDER	THERMAL POWER [kW]	PUMP CAPACITY [l/hour]	HEATING TIME ⁽¹⁾ [min]	PPRODUCTION DHW AT 45°C [l/hour]
BSM 150	27,90	2450	14	798
BSM 200	34,00	2990	14	970
BSM 300	44,50	3910	14	1275
BSM 400	47,80	4200	19	1370
BSM 500	60,50	5320	18	1730
BSM 800	76,50	6700	22	2190
BSM 1000	100,00	8800	20	2860

(1) Time required to bring the temperature of the cylinder from 15 °C to 45 °C

TABLE OF HEATING ELEMENT APPLICABILITY TO CYLINDERS

Heating element model					Water heating time from 15° C to 60 °C (expressed in minutes) <i>The heating times outlined are approximate</i>							
CODE	Power (kW)	Voltage (Volt)	Connection	Length (mm)	BSM-150	BSM-200	BSM-300	BSM-400	BSM-500	BSM-800	BSM-1000	
8601000	1	220 V / MF	G 1.1/4"	295	480 min.	630 min.	960 min.	1270 min.	1580 min.	2520 min.	3150 min.	
8601650	1.65	220 V / MF	G 1.1/4"	450	285 min.	380 min.	580 min.	770 min.	970 min.	1550 min.	1920 min.	
8602000	2	220 V / MF	G 1.1/4"	515	n.a.	n.a.	n.a.	640 min.	800 min.	1270 min.	1580 min.	
8602600	2.6	220 V / MF	G 1.1/4"	675	n.a.	n.a.	n.a.	n.a.	n.a.	980 min.	1230 min.	
8602601	2.6	220 V / MF	G 1.1/4"	360	180 min.	250 min.	370 min.	490 min.	630 min.	980 min.	1230 min.	
8603300	3.3	220 V / MF	G 1.1/4"	825	n.a.	n.a.	n.a.	n.a.	n.a.	n.a.	n.a.	
8603301	3.3	220 V / MF	G 1.1/4"	435	145 min.	200 min.	295 min.	390 min.	490 min.	780 min.	980 min.	
8604001	4	220 V / MF	G 1.1/4"	510	n.a.	n.a.	n.a.	320 min.	410 min.	640 min.	800 min.	
8705000	5	380 V / TF	G 1.1/2"	445	95 min.	140 min.	200 min.	260 min.	330 min.	520 min.	640 min.	
8706000	6	380 V / TF	G 1.1/2"	510	n.a.	n.a.	n.a.	220 min.	280 min.	430 min.	540 min.	
8708000	8	380 V / TF	G 1.1/2"	670	n.a.	n.a.	n.a.	n.a.	n.a.	330 min.	420 min.	
8710000	10	380 V / TF	G 1.1/2"	820	n.a.	n.a.	n.a.	n.a.	n.a.	n.a.	n.a.	
8712000	12	380 V / TF	G 1.1/2"	970	n.a.	n.a.	n.a.	n.a.	n.a.	n.a.	n.a.	

n.a.= Heating element not applicable

SEE TABLE OF SYMBOLS
IN THE SHUTTER OF THE
COVER

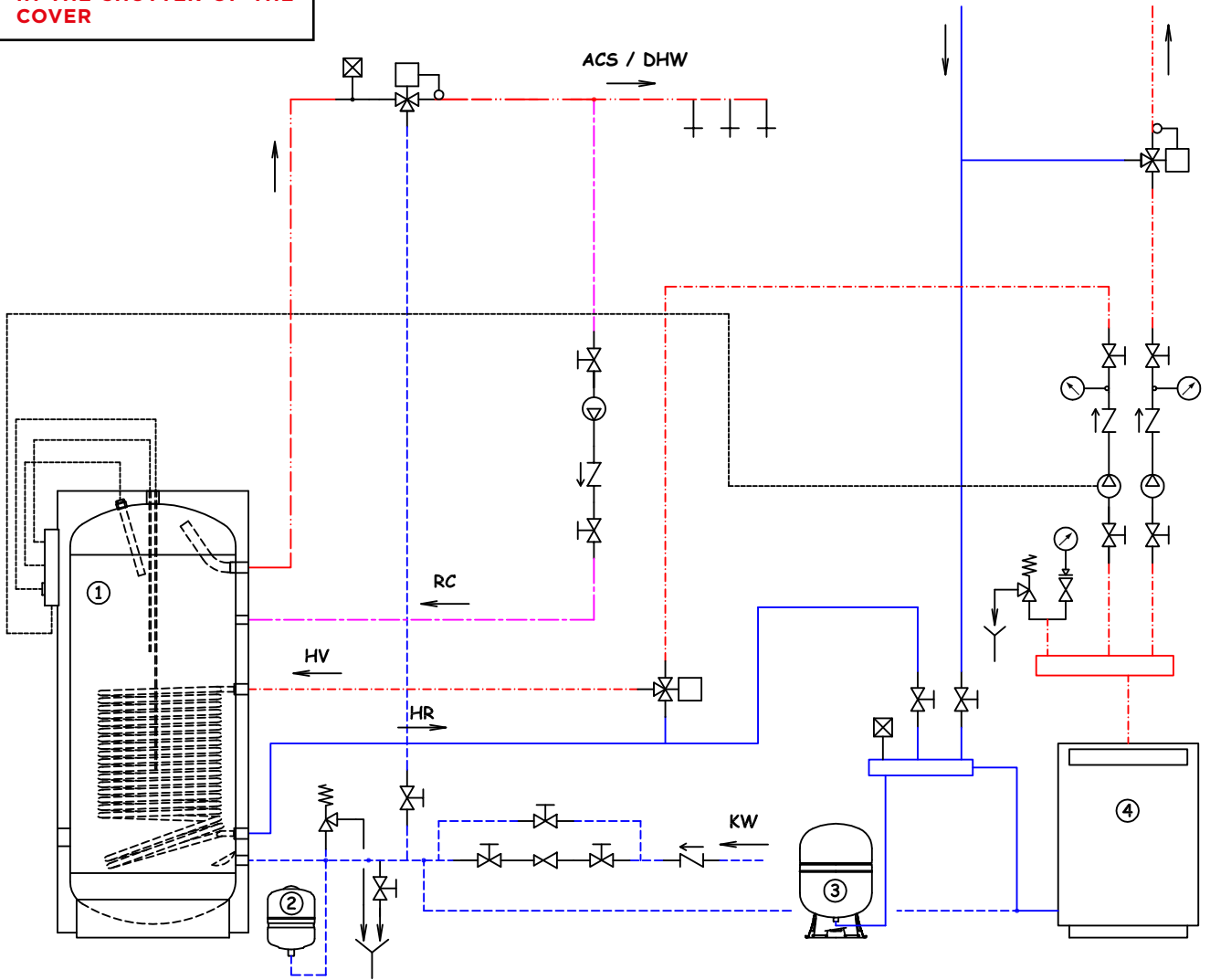





BST

GLASSLINED CYLINDER FOR SOLAR THERMAL USE WITH TWO FIXED EXCHANGERS (200 - 2.000 LITRES)

BST 1500 - 2000

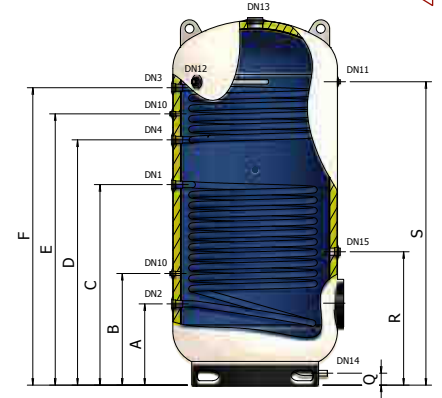
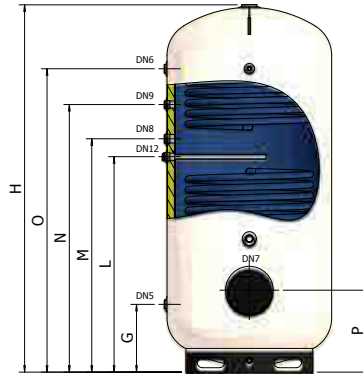
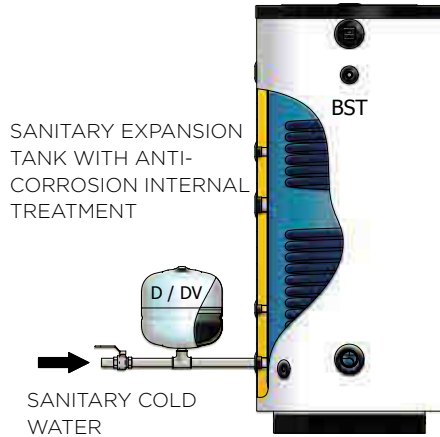

BST 800 - 1000

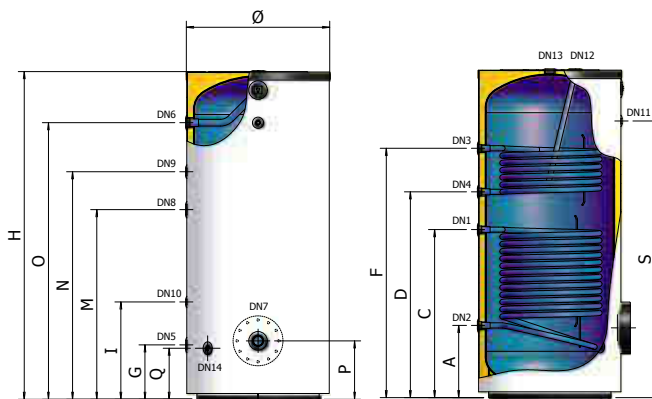

BST 200 - 300 - 400 - 500

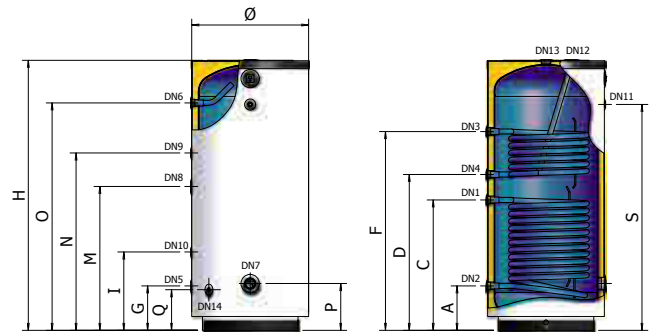

KEYWORD

DN1: Solar exchanger inlet; **DN2:** Solar exchanger outlet; **DN3:** Boiler exchanger inlet; **DN4:** Boiler exchanger outlet;
DN5: Sanitary cold water inlet; **DN6:** Sanitary hot water outlet; **DN7:** Heating element / Visual indicator light; **DN8:** Heating element;
DN9: Recirculation; **DN10:** Thermostat; **DN11:** Thermometer; **DN12:** Magnesium anode; **DN13:** Sanitary hot water outlet; **DN14:** Drain;
DN15: Sanitary expansion tank;



CYLINDER



FOR SANITARY HOT WATER



SUITABLE FOR SOLAR SYSTEMS



ANODE WITH TESTER (200 - 1000)



2 MAGNESIUM ANODES (1500 - 2000)



INTERNAL, ANTI-CORROSION GLASSLINING TREATMENT



POLYURETHANE INSULATION



+ 95°C
CYLINDER
MAX TEMPERATURE



+ 110°C
MAX TEMPERATURE OF
EXCHANGER

P_{MAX} 10 bar (200 - 1000)
MAX WORKING PRESSURE

P_{MAX} 6 bar (1500 - 2000)
MAX WORKING PRESSURE

P_{SCA} 12 bar
MAX PRESSURE
OF EXCHANGER

WARRANTY: 5 YEARS

REFERENCE STANDARDS

CYLINDER:

2014/68/UE Directive - ART. 4.3, without CE marking
Standard EN 12897:2016

Designed and built in accordance with the requirements of the 2009/125/EC.

Labeling in accordance with the requirements of the 2010/30/EU.

INTERNAL GLASS LINING:

DIN 4753

The glasslining treatment makes the cylinder suitable to contain hot water for sanitary and hygienic use and resistant to corrosive phenomena.

INSULATION:

Expanded polyurethane without CFC and HCFC



HEAT EXCHANGER:

fixed double coil

INSTALLATION:

- traditional boilers (wall-hung and/or floor-standing)
- condensing boilers
- solar thermal systems

DIMENSIONS

MODEL	CODE	ENERGY LABEL		EXCHANGER								NOTES
				LOWER			UPPER					
				CL	LITRES	m ²	LITRES	m ²	LITRES			
BST-200	A3E0L47 PGP40	C	200	0,70	5	0,50	4	600	1170			
BST-300	A3E0L51 PGP40	C	300	1,20	8	0,75	5	650	1395			
BST-400	A3E0L53 PGP40	D	400	1,40	9	0,90	6	750	1445			
BST-500	A3E0L55 PGP40	D	500	1,80	12	0,90	6	750	1695			
BST-800	A3E0L60 PGP40	/	800	2,00	13	1,20	8	900	1795			
BST-1000	A3E0L62 PGP40	/	1000	2,40	15	1,20	8	900	2045			
BST-800+FL.	A3E1L60 SWS50	/	800	2,00	13	1,20	8	900	1795			
BST-1000+FL.	A3E1L62 SWS50	/	1000	2,40	15	1,20	8	900	2045			
BST-1500+FL.	A3E1H67 VW050	/	1500	3,60	36	1,60	16	1100	2465			
BST-2000+FL.	A3E1H70 VW050	/	2000	4,30	43	2,10	21	1200	2445			

MODEL	A mm	C mm	D mm	F mm	G mm	I mm	M mm	N mm	O mm	P mm	Q mm	S mm
BST-200	235	585	680	930	235	350	635	760	935	250	220	935
BST-300	255	710	815	1085	255	405	760	950	1165	270	240	1155
BST-400	280	685	805	1075	280	470	745	940	1190	295	265	1170
BST-500	280	820	980	1250	280	495	905	1115	1430	295	265	1420
BST-800	450	910	1060	1330	340	610	985	1195	1470	365	320	1470
BST-1000	450	1045	1280	1550	340	610	1180	1415	1720	365	320	1720
BST-800+FL.	450	910	1060	1330	340	610	985	1195	1470	435	320	1470
BST-1000+FL.	450	1045	1280	1550	340	610	1180	1415	1720	435	320	1720
BST-1500+FL.	545	1345	1645	1995	455	-	1565	1795	2035	550	80	2035
BST-2000+FL.	515	1405	1605	2025	445	-	1565	1785	2025	540	80	2025

MODEL	ANODE ø x ø conn. x L	DN 1	DN 2	DN 3	DN 4	DN 5	DN 6	DN 7	DN 8	DN 9	DN 10	DN 11	DN 12	DN 13	DN 14
		BST-200	32 x 1.1/4" x 350	1"	1"	1"	1"	1"	1"	2"	1.1/2"	3/4"	1/2"	1/2"	1.1/4"
BST-300	32 x 1.1/4" x 550	1"	1"	1"	1"	1"	1"	2"	1.1/2"	3/4"	1/2"	1/2"	1.1/4"	1.1/4"	1/2"
BST-400	32 x 1.1/4" x 550	1"	1"	1"	1"	1"	1"	2"	1.1/2"	3/4"	1/2"	1/2"	1.1/4"	1.1/4"	1/2"
BST-500	32 x 1.1/4" x 700	1"	1"	1"	1"	1"	1"	2"	1.1/2"	3/4"	1/2"	1/2"	1.1/4"	1.1/4"	1/2"
BST-800	32 x 1.1/4" x 700	1"1/4	1"1/4	1"1/4	1"1/4	1.1/4"	1.1/4"	2"	1.1/2"	1"	1/2"	1/2"	1.1/4"	1.1/4"	3/4"
BST-1000	32 x 1.1/4" x 700	1"1/4	1"1/4	1"1/4	1"1/4	1.1/4"	1.1/4"	2"	1.1/2"	1"	1/2"	1/2"	1.1/4"	1.1/4"	3/4"
BST-800+FL.	32 x 1.1/4" x 700	1"1/4	1"1/4	1"1/4	1"1/4	1.1/4"	1.1/4"	Øi 220	1.1/2"	1"	1/2"	1/2"	1.1/4"	1.1/4"	3/4"
BST-1000+FL.	32 x 1.1/4" x 700	1"1/4	1"1/4	1"1/4	1"1/4	1.1/4"	1.1/4"	Øi 220	1.1/2"	1"	1/2"	1/2"	1.1/4"	1.1/4"	3/4"
BST-1500+FL.	32 x 1.1/4" x 670	1.1/4"	1.1/4"	1.1/4"	1.1/4"	1.1/4"	1.1/4"	Øi 220	1.1/2"	1.1/4"	1/2"	1/2"	1.1/4"	3"	1"
BST-2000+FL.	32 x 1.1/4" x 670	1.1/4"	1.1/4"	1.1/4"	1.1/4"	1.1/4"	1.1/4"	Øi 220	1.1/2"	1.1/4"	1/2"	1/2"	1.1/4"	3"	1"

MODEL	B mm	E mm	L mm	R mm	DN 15
BST-1500+FL.	750	1820	1445	895	1.1/4"
BST-2000+FL.	740	1780	1455	885	1.1/4"

TECHNICAL CHARACTERISTICS

MODEL	MAX WORKING PRESSURE CYLINDER (Secondary circuit)	MAX. WORKING PRESSURE HEAT EXCHANGER (Primary circuit)	HEAT EXCHANGERS PRESSURE DROP	
			LOWER HEAT EXCHANGER	UPPER HEAT EXCHANGER
BST 200	10 bar	12 bar	20 mbar	10 mbar
BST 300			80 mbar	25 mbar
BST 400			120 mbar	35 mbar
BST 500			265 mbar	35 mbar
BST 800			55 mbar	15 mbar
BST 1000			90 mbar	15 mbar
BST 1500	6 bar		265 mbar	30 mbar
BST 2000			425 mbar	60 mbar

MODEL	INSULATION TYPE	INSULATION THICKNESS	INSULATION DENSITY	INITIAL THERMAL CONDUCTIVITY	(*) INSULATION THERMAL LOSS	EXTERNAL COVER
BST 200	95% closed cells rigid expanded polyurethane, CFC - HCFC free	50 mm	40 kg/m ³	23,5 mW/m K	1,992 kWh / 24h	Grey polystyrene RAL 9006
BST 300					2,208 kWh / 24h	
BST 400					2,856 kWh / 24h	
BST 500					3,192 kWh / 24h	
BST 800					3,958 kWh / 24h	
BST 1000					4,449 kWh / 24h	
BST 1500	Open cells flexible expanded polyurethane	50 mm	15 kg/m ³	39,0 mW/m K	9,969 kWh / 24h	Skay bianco RAL 9001
BST 2000					10,865 kWh / 24h	

(*) Thermal loss calculated with an accumulation temperature equal to 65 °C and with an external temperature equal to 20 °C.

STANDARD EQUIPMENT

- Anode tester (200 - 1000)

SAFETY DEVICES

The cylinders must be protected from the effects of over pressure by installing:

- **SAFETY VALVE** calibrated to pressure lower than the max. cylinder pressure
- **SANITARY EXPANSION TANK** mod. ELBI **D - DV series**
- **SOLAR EXPANSION TANK** mod. ELBI **DS - DSV series**

RECOMMENDED EXPANSION TANK

MODEL	SANITARY CIRCUIT (mod. ELBI D-DV series)	LOWER COIL (mod. ELBI DS-DSV series)
BST 200	D - 18	DS - 18
BST 300	D - 24	DS - 18
BST 400	D - 35	DS - 24
BST 500	D - 35	DS - 24
BST 800	DV - 50	DS - 35
BST 1000	DV - 80	DSV - 50
BST 1500	DV - 150	DSV - 80
BST 2000	DV - 150	DSV - 100

Dimensioning carried out with the following parameters: T. accumulation = 85 °C / T. inlet = 15 °C / P. pre-charge = 3 bar / P. max = 6 bar
The recommended capacities must be verified on the basis of the actual dimensions of the system implemented.

MODEL	MAGNESIUM ANODE SUPPLIED	CATHODIC PROTECTION APPLICABLE
BST 200	1,1/4" x 350 / Cod.8560046	Cathodic protection for cylinders 100/400 l. Code 8560170
BST 300	1,1/4" x 550 / Cod.8560066	
BST 400	1,1/4" x 550 / Cod.8560066	
BST 500	1,1/4" x 700 / Cod.8560086	Cathodic protection for cylinders 500/1000 l. Code 8560175
BST 800	1,1/4" x 700 / Cod.8560086	
BST 1000	1,1/4" x 700 / Cod.8560086	
BST 1500	n.2 x 1,1/4" x 670 / Cod. 8560070	Cathodic protection for cylinders 1500/2500 l. Code 8560180
BST 2000	n.2 x 1,1/4" x 670 / Cod. 8560070	

BST CYLINDERS ARE SELECTED BASED ON MULTIPLE FACTORS THAT CAN BE BRIEFLY SUMMARISED AS FOLLOWS:

- SANITARY HOT WATER REQUIRED
- SUNLIGHT
- CYLINDER CAPACITY FOR THE NUMBER OF PEOPLE
- SOLAR COLLECTOR SURFACE FOR CYLINDER CAPACITY

SOLAR LIGHT:
LEVEL OF SUNLIGHT PER YEAR IN EUROPE (kWh/m²)

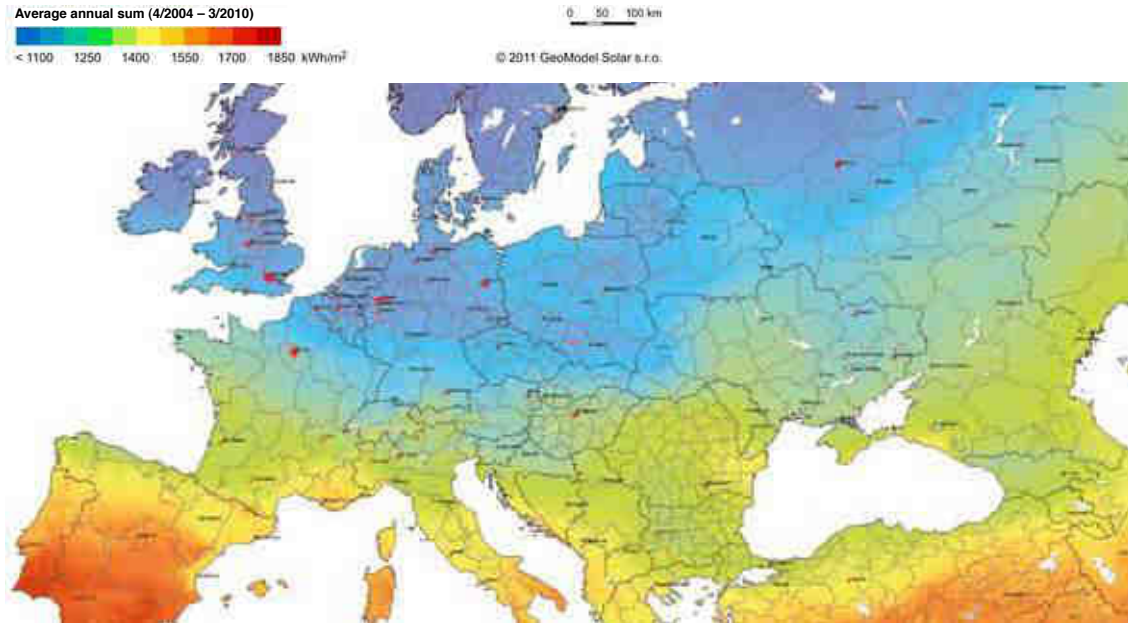

CYLINDER MODELS PER NUMBER OF PEOPLE:

MODEL	Number of people
BST 200	1 - 2
BST 300	2 - 4
BST 400	3 - 5
BST 500	5 - 7
BST 800	max. 10
BST 1000	max. 18
BST 1500	max. 22
BST 2000	max. 38

SOLAR COLLECTOR SURFACE TO COMBINE WITH THE SELECTED MODEL:

MODEL	Solar collector surface (m ²)
BST 200	2.5
BST 300	5
BST 400	7.5
BST 500	10
BST 800	12.5
BST 1000	15
BST 1500	17,5
BST 2000	20

TABLE OF HEATING ELEMENT APPLICABILITY TO CYLINDERS

Heating element model					Water heating time from 15° C to 60 °C (expressed in minutes) <i>The heating times outlined are approximate</i>							
CODE	Power (kW)	Voltage (Volt)	Connection	Length (mm)	BST-200	BST-300	BST-400	BST-500	BST-800	BST-1000	BST-1500	BST-2000
8601000	1	220 V / MF	G 1.1/4"	295	630 min.	960 min.	1270 min.	1580 min.	2520 min.	3150 min.	4720 min.	6300 min.
8601650	1.65	220 V / MF	G 1.1/4"	450	380 min.	580 min.	770 min.	970 min.	1550 min.	1920 min.	2870 min.	3820 min.
8602000	2	220 V / MF	G 1.1/4"	515	n.a.	n.a.	640 min.	800 min.	1270 min.	1580 min.	2370 min.	3150 min.
8602600	2.6	220 V / MF	G 1.1/4"	675	n.a.	n.a.	n.a.	n.a.	980 min.	1230 min.	1830 min.	2450 min.
8602601	2.6	220 V / MF	G 1.1/4"	360	250 min.	370 min.	490 min.	630 min.	980 min.	1220 min.	1830 min.	2450 min.
8603300	3.3	220 V / MF	G 1.1/4"	825	n.a.	n.a.	n.a.	n.a.	n.a.	n.a.	1450 min.	1940 min.
8603301	3.3	220 V / MF	G 1.1/4"	435	200 min.	295 min.	390 min.	490 min.	780 min.	980 min.	1450 min.	1940 min.
8604001	4	220 V / MF	G 1.1/4"	510	n.a.	n.a.	320 min.	410 min.	640 min.	800 min.	1200 min.	1600 min.
8705000	5	380 V / TF	G 1.1/2"	445	140 min.	200 min.	260 min.	330 min.	520 min.	640 min.	950 min.	1300 min.
8706000	6	380 V / TF	G 1.1/2"	510	n.a.	n.a.	220 min.	280 min.	430 min.	540 min.	800 min.	1060 min.
8708000	8	380 V / TF	G 1.1/2"	670	n.a.	n.a.	n.a.	n.a.	330 min.	420 min.	610 min.	800 min.
8710000	10	380 V / TF	G 1.1/2"	820	n.a.	n.a.	n.a.	n.a.	n.a.	n.a.	490 min.	640 min.
8712000	12	380 V / TF	G 1.1/2"	970	n.a.	n.a.	n.a.	n.a.	n.a.	n.a.	410 min.	540 min.

n.a.= Heating element not applicable

ACCUMULATION AT 60 °C

LOW HEAT EXCHANGER: T.inlet = 80°C; ΔT = 10°C.

STORAGE WATER HEATER: T.inlet =15°C; T.accumulation= 60°C

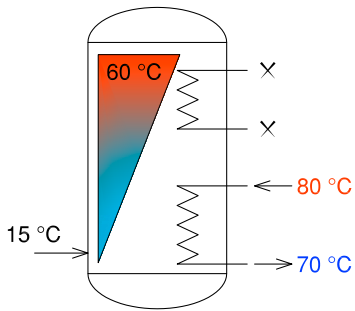

MODEL	THERMAL POWER [kW]	PUMP CAPACITY [l/hour]	HEATING TIME ⁽¹⁾ [min]	PRODUCTION DHW AT 60°C [l/hour]	QUANTITY DHW AT 45°C FOR FIRST 10 min. ⁽²⁾ [l]
BST 200	16,50	1450	38	315	195
BST 300	29,00	2600	31	554	310
BST 400	34,50	3000	38	659	395
BST 500	44,00	3850	35	840	495
BST 800	50,00	4400	49	955	668
BST 1000	60,00	5300	47	1145	770
BST 1500	79,00	6900	60	1500	1040
BST 2000	93,00	8200	67	1800	1300

(1) Time required to bring the temperature of the cylinder from 15 °C to 60 °C

(2) Quantity of DHW (Sanitary Hot Water) at 45°C available in first 10 minutes with accumulation of DHW at 60° C.

ACCUMULATION AT 60 °C

UP HEAT EXCHANGER: T.inlet = 80°C; ΔT = 10°C.

STORAGE WATER HEATER: T.inlet =15°C; T.accumulation= 60°C

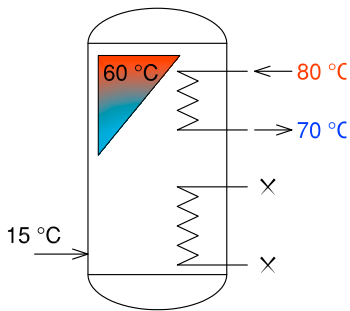

MODEL	THERMAL POWER [kW]	PUMP CAPACITY [l/hour]	HEATING TIME ⁽¹⁾ [min]	PPRODUCTION DHW AT 60°C [l/hour]
BST 200	11,50	1000	24	220
BST 300	18,00	1500	22	340
BST 400	21,00	1850	28	400
BST 500	21,00	1850	32	400
BST 800	29,00	2500	35	550
BST 1000	29,00	2500	37	550
BST 1500	35,00	3100	36	675
BST 2000	46,70	4100	44	890

(1) Time required to bring the temperature of the upper part of the cylinder (about 1/3 of the total volume) from 15 °C to 60 °C.

ACCUMULATION AT 60 °C

DOUBLE HEAT EXCHANGER: T.inlet = 80°C; ΔT = 10°C.

STORAGE WATER HEATER: T.inlet =15°C; T.accumulation= 60°C

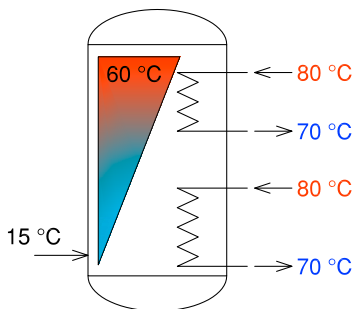

MODEL	THERMAL POWER [kW]	UPPER PUMP CAPACITY [l/hour]	LOWER PUMP CAPACITY [l/hour]	HEATING TIME ⁽¹⁾ [min]	PRODUCTION DHW AT 60°C [l/hour]
BST 200	28,00	1000	1450	22	530
BST 300	47,00	1500	2600	20	890
BST 400	55,50	1850	3000	23	1050
BST 500	65,00	1850	3850	24	1240
BST 800	79,00	2500	4400	32	1500
BST 1000	89,00	2500	5300	35	1700
BST 1500	114,00	3100	6900	41	2170
BST 2000	139,70	4100	8200	45	2670

(1) Time required to bring cylinder temperature from 15 °C to 60°C

ACCUMULATION AT 45 °C

LOW HEAT EXCHANGER: T.inlet = 80°C; ΔT = 10°C.

STORAGE WATER HEATER: T.inlet =15°C; T.accumulation= 45°C

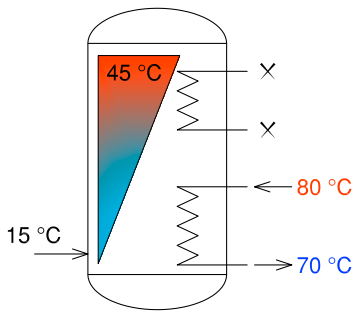

MODEL	THERMAL POWER [kW]	PUMP CAPACITY [l/hour]	HEATING TIME ⁽¹⁾ [min]	PRODUCTION DHW AT 45°C [l/hour]
BST 200	20,00	1760	21	570
BST 300	35,00	3000	18	1000
BST 400	40,00	3500	22	1140
BST 500	53,00	4670	20	1500
BST 800	59,50	5200	28	1700
BST 1000	68,50	6000	28	1960
BST 1500	95,00	8300	33	2700
BST 2000	112,00	9850	37	3200

(1) Time required to bring the temperature of the cylinder from 15 °C to 45 °C

ACCUMULATION AT 45 °C

UP HEAT EXCHANGER: T.inlet = 80°C; ΔT = 10°C.

STORAGE WATER HEATER: T.inlet =15°C; T.accumulation= 45°C

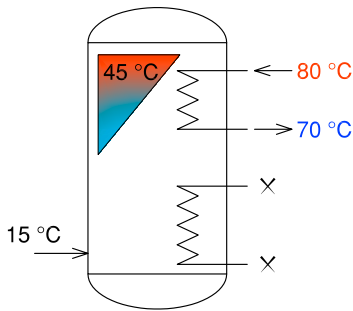

MODEL	THERMAL POWER [kW]	PUMP CAPACITY [l/hour]	HEATING TIME ⁽¹⁾ [min]	PRODUCTION DHW AT 45°C [l/hour]
BST 200	14,00	1230	14	400
BST 300	21,50	1840	13	610
BST 400	26,00	2230	16	740
BST 500	26,00	2230	18	740
BST 800	36,00	3170	19	1020
BST 1000	36,00	3170	20	1020
BST 1500	42,00	3700	20	1210
BST 2000	56,00	4900	24	1600

(1) Time required to bring the temperature of the upper part of the cylinder (about 1/3 of the total volume) from 15 °C to 45 °C.

ACCUMULATION AT 45 °C

DOUBLE HEAT EXCHANGER: T.inlet = 80°C; ΔT = 10°C.

STORAGE WATER HEATER: T.inlet =15°C; T.accumulation= 45°C

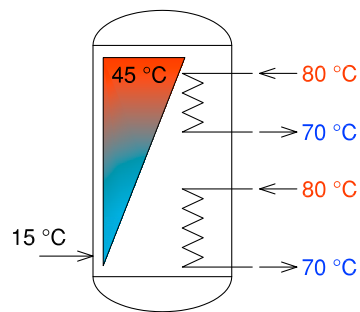

MODELLO	THERMAL POWER [kW]	UPPER PUMP CAPACITY [l/hour]	LOWER PUMP CAPACITY [l/hour]	HEATING TIME ⁽¹⁾ [min]	PRODUCTION DHW AT 45°C [l/hour]
BST 200	34,00	1760	1230	12	970
BST 300	56,50	3000	1840	11	1580
BST 400	66,00	3500	2230	13	1870
BST 500	79,00	4670	2230	13	2250
BST 800	95,50	5200	3170	18	2730
BST 1000	104,50	6000	3170	20	2990
BST 1500	137,00	8300	3700	23	3920
BST 2000	168,00	9850	4900	25	4810

(1) Time required to bring cylinder temperature from 15 °C to 45°C

HYDRAULIC DIAGRAM 1 (BST CYLINDER WITH SOLAR CIRCUIT AND INTEGRATION)

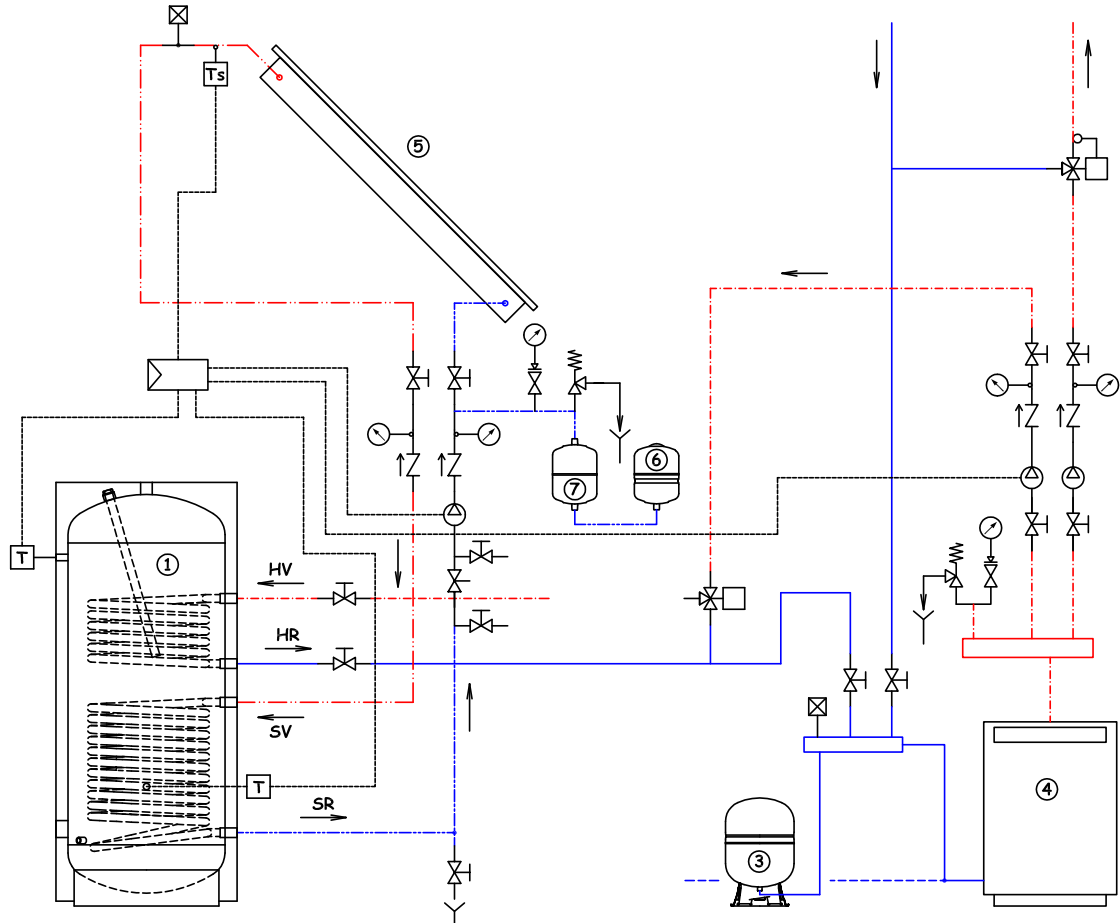

HYDRAULIC DIAGRAM 2 (BST CYLINDER WITH SANITARY CIRCUIT)

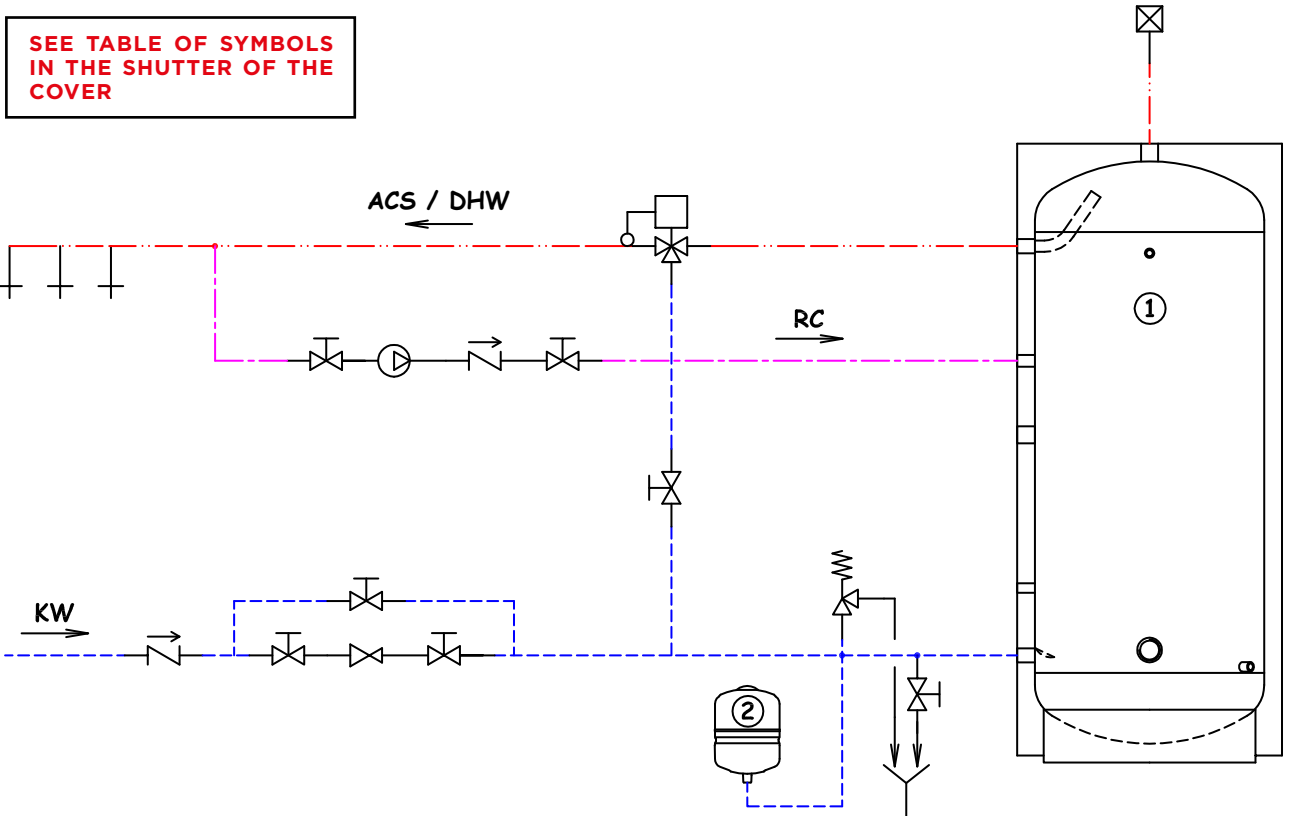





BSPT

GLASSLINED DHW CYLINDER

WITH TWO FIXED EXCHANGERS FOR HEAT PUMPS (300 - 1.000 LITRES)

BSPT 300 - 1000

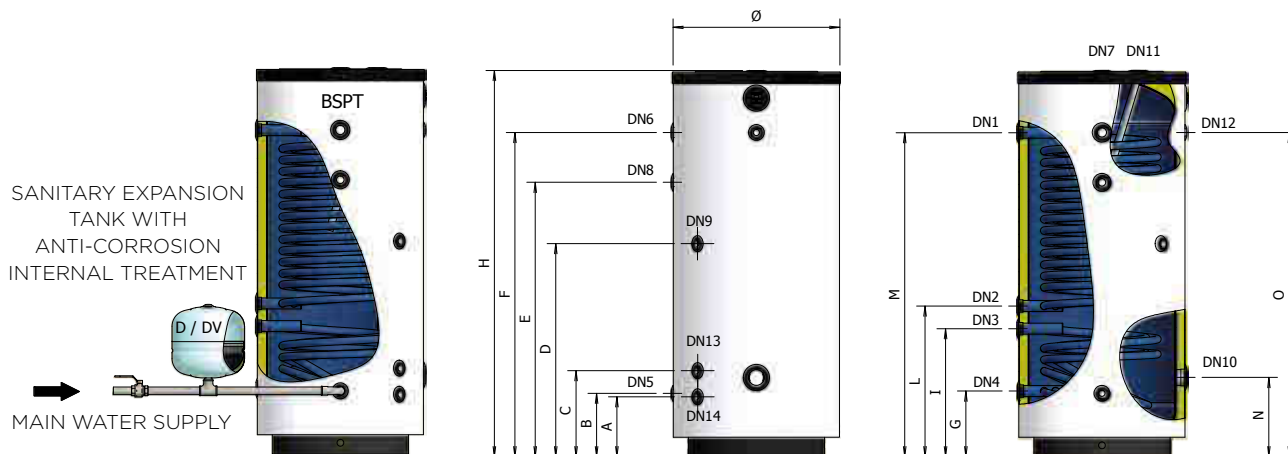

KEYWORD

DN1: Heat pump exchanger inlet; **DN2:** Heat pump exchanger outlet; **DN3:** Boiler exchanger inlet; **DN4:** Boiler exchanger outlet; **DN5:** Sanitary cold water inlet; **DN6:** Sanitary hot water outlet; **DN7:** Sanitary hot water outlet; **DN8:** Recirculation; **DN9:** Probe; **DN10:** Heating element/Visual indicator light; **DN11:** Magnesium anode; **DN12:** Thermometer; **DN13:** Probe; **DN14:** Drain.

CYLINDER

FOR SANITARY HOT WATER

SUITABLE FOR SOLAR SYSTEMS

ANODE WITH TESTER (150 - 1000)

POLYURETHANE INSULATION

SUITABLE FOR HEATING PUMP

+ 95°C
CYLINDER
MAX TEMPERATURE

+ 110°C
MAX TEMPERATURE OF
EXCHANGER

P_{MAX} 10 bar
CYLINDER MAX WORKING
PRESSURE

P_{SCA} 12 bar
HEAT EXCHANGER
MAX PRESSURE

REFERENCE STANDARDS

CYLINDER:

Directive 2014/68/UE - ART. 4.3 without CE marking
Standard EN 12897:2016

INTERNAL GLASS LINING:

DIN 4753

The glasslining treatment makes the cylinder suitable to contain hot water for sanitary and hygienic use and resistant to corrosive phenomena.

WARRANTY: 5 YEARS

INSULATION:

Expanded polyurethane without CFC and HCFC

HEAT EXCHANGER:



two fixed double-tube coil in stainless steel AISI 316 L

INSTALLATION:

· heat pumps

DIMENSIONS

EXCHANGER

MODEL	CODE	ENERGY LABEL CL		LOWER		UPPER				NOTES	
				LITRES	m ²	LITRES	m ²				LITRES
BSPT-300	A3T2L51 VG250	C		300	0,9	6	2,2	13	650	1400	
BSPT-500	A3T2L55 VG250	D		500	1,1	7	4	24	750	1695	
BSPT-800	A3T2L60 VG250	/		800	1,9	12	5,3	32	990	1835	
BSPT-1000	A3T2L62 VG250	/		1000	3	18	5,7	36	990	2285	

MODEL	DN 1	DN 2	DN 3	DN 4	DN 5	DN 6	DN 7	DN 8	DN 9	DN 10	DN 11	DN 12	DN 13	DN 14
BSPT-300	1 1/4"	1 1/4"	1 1/4"	1 1/4"	1"	1"	1 1/4"	3/4"	1/2"	2"	1 1/4"	1/2"	1/2"	1/2"
BSPT-500	1 1/4"	1 1/4"	1 1/4"	1 1/4"	1"	1"	1 1/4"	3/4"	1/2"	2"	1 1/4"	1/2"	1/2"	1/2"
BSPT-800	1 1/4"	1 1/4"	1 1/4"	1 1/4"	1 1/4"	1 1/4"	1 1/4"	1"	1/2"	2"	1 1/4"	1/2"	1/2"	3/4"
BSPT-1000	1 1/4"	1 1/4"	1 1/4"	1 1/4"	1 1/4"	1 1/4"	1 1/4"	1"	1/2"	2"	1 1/4"	1/2"	1/2"	3/4"

MODEL	A mm	B mm	C mm	D mm	E mm	F mm	G mm	I mm	L mm	M mm	N mm	O mm
BSPT-300	245	260	360	780	995	1160	270	525	625	1150	330	1160
BSPT-500	265	280	380	940	1210	1430	290	555	655	1420	350	1430
BSPT-800	315	330	440	1020	1270	1480	350	650	755	1460	410	1480
BSPT-1000	315	300	450	1270	1450	1730	360	795	950	1700	420	1730

TECHNICAL CHARACTERISTICS

HEAT EXCHANGERS PRESSURE DROP

MODEL	MAX WORKING PRESSURE CYLINDER (Secondary circuit)	MAX. WORKING PRESSURE HEAT EXCHANGER (Primary circuit)	HEAT EXCHANGERS PRESSURE DROP	
			LOWER HEAT EXCHANGER	UPPER HEAT EXCHANGER
BSPT-300	10 bar	12 bar	59 mbar	25 mbar
BSPT-500			106 mbar	30 mbar
BSPT-800			141 mbar	52 mbar
BSPT-1000			152 mbar	82 mbar

MODEL	INSULATION TYPE	INSULATION THICKNESS	INSULATION DENSITY	INITIAL THERMAL CONDUCTIVITY	(*) INSULATION THERMAL LOSS	EXTERNAL COVER
BSPT-300	rigid polyurethane	50 mm	40 kg/m ³	23,5 mW/m K	2,208 kWh / 24h	Grey polystyrene RAL 9006
BSPT-500					3,192 kWh / 24h	
BSPT-800					3,958 kWh / 24h	
BSPT-1000					4,449 kWh / 24h	

(*) Thermal loss calculated with an accumulation temperature equal to 65 °C and with an external temperature equal to 20 °C.

STANDARD EQUIPMENT

- Anode tester

SAFETY DEVICES

The cylinders must be protected from the effects of over pressure by installing:

- **SAFETY VALVE** calibrated to pressure lower than the max. cylinder pressure
- **SANITARY EXPANSION TANK** mod. ELBI D - DV series

RECOMMENDED EXPANSION TANK

MODEL	SANITARY CIRCUIT (mod. ELBI D-DV series)	LOWER COIL (mod. ELBI DS-DSV series)
BSPT-300	D - 24	DS - 35
BSPT-500	D - 35	DSV - 50
BSPT-800	DV - 50	DSV - 80
BSPT-1000	DV - 80	DSV - 80

Dimensioning carried out with the following parameters: T. accumulation = 85 °C / T. inlet = 15 °C / P. pre-charge = 3 bar / P. max = 6 bar
The recommended capacities must be verified on the basis of the actual dimensions of the system implemented.

MODEL	MAGNESIUM ANODE SUPPLIED	CATHODIC PROTECTION APPLICABLE
BSPT-300	1 1/4" x 550 / Cod. 8560066	Cathodic protection for cylinders lt. 300 Code 8560170
BSPT-500	1 1/4" x 700 / Cod. 8560086	Cathodic protection for cylinders 500/1000 l. Code 8560175
BSPT-800		
BSPT-1000		

ACCUMULATION AT 45 °C

HEAT EXCHANGER: $T_{inlet} = 60^{\circ}\text{C}$; $\Delta T = 10^{\circ}\text{C}$.

STORAGE WATER HEATER: $T_{inlet} = 15^{\circ}\text{C}$; $T_{accumulation} = 45^{\circ}\text{C}$

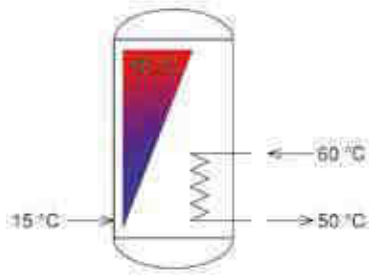

MODEL	THERMAL POWER [kW]	PUMP CAPACITY [l/hour]	HEATING TIME ⁽¹⁾ [min]	PRODUCTION DHW AT 45°C [l/hour]
BSPT 300	32	2810	20	915
BSPT 500	58	5105	18	1665
BSPT 800	77	6765	22	2210
BSPT 1000	83	7275	26	2375

(1) Time required to bring the temperature of the cylinder from 15 °C to 45 °C

ACCUMULATION AT 45 °C

UP HEAT EXCHANGER: $T_{inlet} = 80^{\circ}\text{C}$; $\Delta T = 10^{\circ}\text{C}$.

STORAGE WATER HEATER: $T_{inlet} = 15^{\circ}\text{C}$; $T_{accumulation} = 45^{\circ}\text{C}$

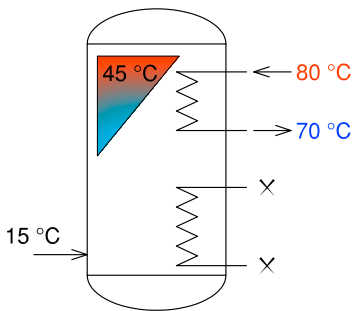

MODEL	THERMAL POWER [kW]	PUMP CAPACITY [l/hour]	HEATING TIME ⁽¹⁾ [min]	PRODUCTION DHW AT 45°C [l/hour]
BSPT 300	23,5	2060	27	675
BSPT 500	29	2520	37	825
BSPT 800	50	4355	34	1425
BSPT 1000	78,5	6875	27	2250

(1) Time required to bring the temperature of the upper part of the cylinder (about 1/3 of the total volume) from 15 °C to 45 °C

ACCUMULATION AT 45 °C

DOUBLE HEAT EXCHANGER: $T_{inlet} = 80^{\circ}\text{C}$; $\Delta T = 10^{\circ}\text{C}$.

STORAGE WATER HEATER: $T_{inlet} = 15^{\circ}\text{C}$; $T_{accumulation} = 45^{\circ}\text{C}$

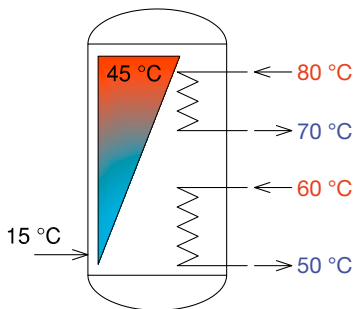

MODEL	THERMAL POWER [kW]	LOWER PUMP CAPACITY [l/hour]	UPPER PUMP CAPACITY [l/hour]	HEATING TIME ⁽¹⁾ [min]	PRODUCTION DHW AT 45°C [l/hour]
BSPT 300	55,5	2810	2060	23	1590
BSPT 500	87	5105	2520	25	2490
BSPT 800	127	6765	4355	27	3635
BSPT 1000	161,5	7275	6875	26	4625

(1) Time required to bring the temperature of the cylinder from 15 °C to 45 °C

ACCUMULATION AT 60 °C

DOUBLE HEAT EXCHANGER: $T_{inlet} = 80^{\circ}\text{C}$; $\Delta T = 10^{\circ}\text{C}$.

STORAGE WATER HEATER: $T_{inlet} = 15^{\circ}\text{C}$; $T_{accumulation} = 45^{\circ}\text{C}$

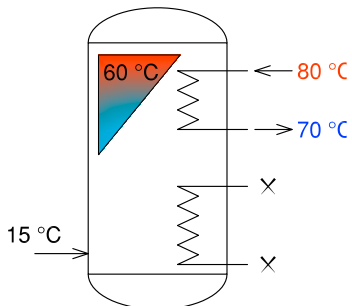

MODEL	THERMAL POWER [kW]	PUMP CAPACITY [l/hour]	HEATING TIME ⁽¹⁾ [min]	PRODUCTION DHW AT 45°C [l/hour]	QUANTITY DHW AT 45°C IN FIRST 10 min
BSPT 300	19,6	1720	48	375	95
BSPT 500	24	2100	66	460	115
BSPT 800	41,5	3630	61	790	198
BSPT 1000	65,5	5730	48	1250	313

(1) Time required to bring the temperature of the upper part of the cylinder (about 1/3 of the total volume) from 15 °C to 60 °C.

TABLE OF HEATING ELEMENT APPLICABILITY TO CYLINDERS

Heating element model	Water heating time from 15° C to 60° C (expressed in minutes) / <i>The heating times outlined are approximate</i>							
	CODE	Power (kW)	Voltage (Volt)	Connection	Length mm	BSPT-300	BSPT-500	BSPT-800
8601000	1	220 V / MF	G 1.1/4"	295	960 min.	1580 min.	2520 min.	3150 min.
8601650	1.65	220 V / MF	G 1.1/4"	450	580 min.	970 min.	1550 min.	1920 min.
8602000	2	220 V / MF	G 1.1/4"	515	n.a.	800 min.	1270 min.	1580 min.
8602600	2.6	220 V / MF	G 1.1/4"	675	n.a.	n.a.	980 min.	1230 min.
8602601	2.6	220 V / MF	G 1.1/4"	360	370 min.	630 min.	980 min.	1230 min.
8603300	3.3	220 V / MF	G 1.1/4"	825	n.a.	n.a.	n.a.	n.a.
8603301	3.3	220 V / MF	G 1.1/4"	435	295 min.	490 min.	780 min.	980 min.
8604001	4	220 V / MF	G 1.1/4"	510	n.a.	410 min.	640 min.	800 min.
8705000	5	380 V / TF	G 1.1/2"	445	200 min.	330 min.	520 min.	640 min.
8706000	6	380 V / TF	G 1.1/2"	510	n.a.	280 min.	430 min.	540 min.
8708000	8	380 V / TF	G 1.1/2"	670	n.a.	n.a.	330 min.	420 min.
8710000	10	380 V / TF	G 1.1/2"	820	n.a.	n.a.	n.a.	n.a.
8712000	12	380 V / TF	G 1.1/2"	970	n.a.	n.a.	n.a.	n.a.

n.a.= Heating element not applicable

HYDRAULIC DIAGRAM KETTLE BSPT HEAT PUMP CIRCUIT - SOLAR

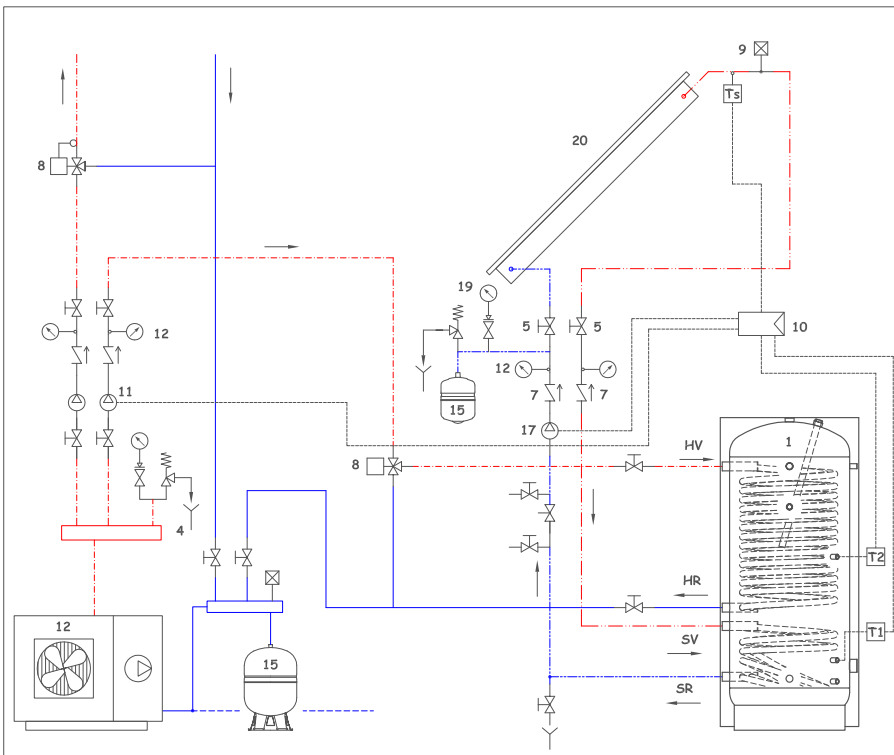

HYDRAULIC DIAGRAM KETTLE BSPT HEALTH CIRCUIT

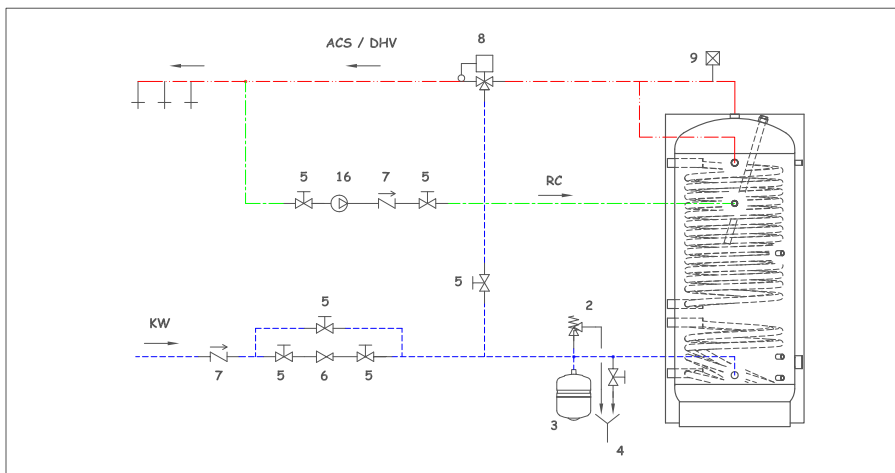



BXV

STAINLESS STEEL CYLINDER

WITH FIXED EXCHANGER FOR SANITARY HOT WATER (170 - 1500 LITRES)

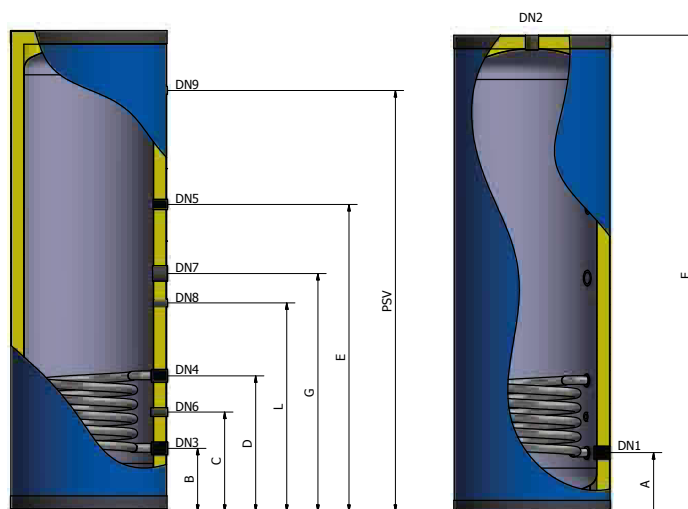
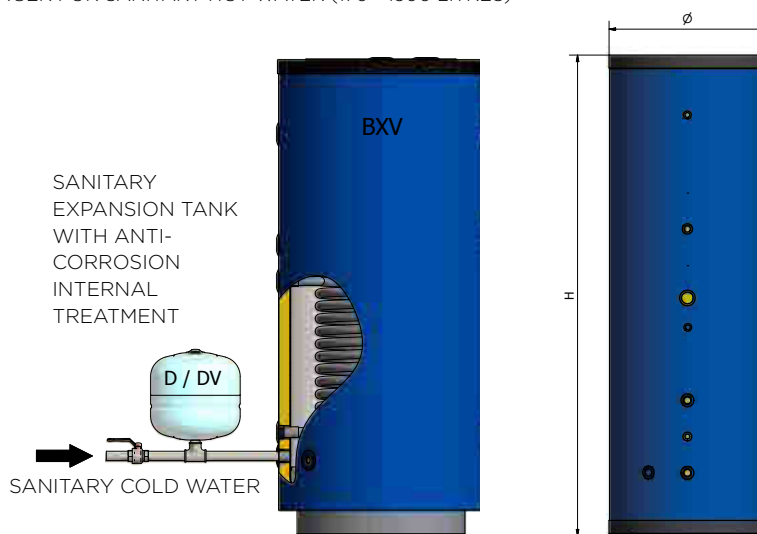

KEYWORD

DN1: Sanitary cold water inlet; **DN2:** Sanitary hot water outlet; **DN3:** Primary fluid outlet, heat exchanger side; **DN4:** Primary fluid inlet, heat exchanger side; **DN5:** Recirculation; **DN6:** Thermostat; **DN7:** Heating element; **DN8:** Thermometer; **DN9:** T&P safety valve.

- CYLINDER
- FOR SANITARY HOT WATER
- SUITABLE FOR SOLAR SYSTEMS
- STAINLESS STEEL AISI 316 L CASING
- POLYURETHANE INSULATION
- EXCHANGER IN STAINLESS STEEL AISI 316 L

- + 99°C
CYLINDER
MAX TEMPERATURE
- + 110°C
MAX TEMPERATURE
OF EXCHANGER
- P_{MAX}** 6 bar
MAX WORKING PRESSURE
- P_{SCA}** 10 bar
MAX PRESSURE
OF EXCHANGER

REFERENCE STANDARDS CYLINDER:

2014/68/UE Directive – ART. 4.3, without CE marking
Ecodesign 2009/125/EC, Energy Labelling 2010/30/EU

WARRANTY: 5 YEARS

INSULATION:

Expanded polyurethane without CFC and HCFC
Blue PVC jacket.

HEAT EXCHANGER:

Fixed single-tube coil in stainless steel AISI 316 L
From BXV 170 to BXV 500 models with corrugated pipe.

INSTALLATION:

- traditional boilers (wall-hung and/or floor-standing)
- condensing boilers
- solar thermal systems

MODEL	CODE	ENERGY LABEL	HEAT EXCHANGER					NOTES
			CL	LITRES	STAINLESS STEEL		mm	
					m ²	LITRES		
BXV-170*	A3X0H45 VB005	B	173	1,2	4,1	610	1070	
BXV-200*	A3X0H47 VB005	B	224	1,2	4,1	610	1320	
BXV-250*	A3X0H49 VB005	C	274	1,2	4,1	610	1570	
BXV-300*	A3X0H51 VB005	C	320	1,2	4,1	610	1820	
BXV-400*	A3X0H53 VB005	C	401	1,5	5,1	710	1590	
BXV-500*	A3X0H55 VB005	C	471	1,5	5,1	710	1820	
BXV-600	A3X0H57 VA010	/	576	2,4	12,8	850	2010	
BXV-800	A3X0H60 VA010	/	781	2,7	14,4	950	2075	
BXV-1000	A3X0H62 VA010	/	977	3,0	16,0	990	2375	
BXV-1500	A3X0H67 VA010	/	1463	3,6	19,2	1150	2465	

*Corrugated pipe

MODEL	A mm	B mm	C mm	D mm	E mm	F mm	G mm	L mm	PSV mm
BXV-170	215	215	355	495	700	1070	615	/	845
BXV-200	215	215	355	495	960	1320	410	310	1095
BXV-250	215	215	355	495	1055	1570	510	395	1345
BXV-300	215	215	355	495	1295	1820	610	495	1595
BXV-400	215	215	355	495	1055	1590	510	395	1345
BXV-500	215	215	355	495	1295	1820	610	495	1595
BXV-600	310	310	450	740	1250	2010	555	440	1690
BXV-800	355	355	495	785	1295	2075	600	485	1735
BXV-1000	355	355	555	955	1495	2375	625	490	2035
BXV-1500	425	425	625	1025	1565	2465	695	560	2105

MODEL	DN 1	DN 2	DN 3	DN 4	DN 5	DN 6	DN 7	DN 8	DN 9	PSV
BXV-170	3/4" M	3/4"	3/4" M	3/4" M	3/4"	1/2"	1.1/2"	1/2"	1/2"	1/2"
BXV-200	3/4" M	3/4"	3/4" M	3/4" M	3/4"	1/2"	1.1/2"	1/2"	1/2"	1/2"
BXV-250	3/4" M	3/4"	3/4" M	3/4" M	3/4"	1/2"	1.1/2"	1/2"	1/2"	1/2"
BXV-300	3/4" M	3/4"	3/4" M	3/4" M	3/4"	1/2"	1.1/2"	1/2"	1/2"	1/2"
BXV-400	1"	1"	3/4" M	3/4" M	3/4"	1/2"	1.1/2"	1/2"	1/2"	1/2"
BXV-500	1"	1"	3/4" M	3/4" M	3/4"	1/2"	1.1/2"	1/2"	1/2"	1/2"
BXV-600	1.1/2"	1.1/2"	1"	1"	1"	1/2"	1.1/2"	1/2"	1/2"	1/2"
BXV-800	1.1/2"	1.1/2"	1"	1"	1"	1/2"	1.1/2"	1/2"	1/2"	1/2"
BXV-1000	1.1/2"	1.1/2"	1"	1"	1"	1/2"	1.1/2"	1/2"	1/2"	1/2"
BXV-1500	1.1/2"	1.1/2"	1"	1"	1"	1/2"	1.1/2"	1/2"	1/2"	1/2"

TECHNICAL CHARACTERISTICS

MODEL	MAX WORKING PRESSURE CYLINDER (Secondary circuit)	MAX. WORKING PRESSURE HEAT EXCHANGER	HEAT EXCHANGER PRESSURE mbar
BXV-170	6 bar	10 bar	1943
BXV-200			1943
BXV-250			1943
BXV-300			1943
BXV-400			2402
BXV-500			2402
BXV-600			1770
BXV-800			2111
BXV-1000			2655
BXV-1500			3935

MODEL	INSULATION TYPE	INSULATION THICKNESS	INSULATION DENSITY	INITIAL THERMAL CONDUCTIVITY	(*) INSULATION THERMAL LOSS	EXTERNAL COVER
BXV-170	Rigid polyurethane	50 mm	40 kg/m ³	23,5 mW/m K	1,224	PVC th. 5mm RAL 5017
BXV-200					1,464	
BXV-250					1,704	
BXV-300					1,896	
BXV-400					2,232	
BXV-500	2,496					
BXV-600	Flexible polyurethane	100 mm	16 kg/m ³	44,2 mW/m K	2,640	
BXV-800					3,264	
BXV-1000					3,816	
BXV-1500					5,040	

(*) Thermal loss calculated with an accumulation temperature equal to 65 °C and with an external temperature equal to 20 °C.

SAFETY DEVICES

The cylinders must be protected from the effects of over pressure by installing:

- A **SAFETY VALVE** calibrated to a pressure lower than the max. pressure of the cylinder;
- A **SANITARY EXPANSION TANK** model **ELBI D - DV series**

MODEL	RECOMMENDED SANITARY EXPANSION TANK (mod. ELBI D-DV series)
BXV-170	D 18
BXV-200	D 18
BXV-250	D 24
BXV-300	D 24
BXV-400	D 35
BXV-500	D 35
BXV-600	DV 50
BXV-800	DV 80
BXV-1000	DV 80
BXV-1500	DV 150

Tank sized using the following parameters: T. accumulation= 85 °C / T. inlet = 15 °C / Pre-charge pressure = 3 bar / Max pressure = 6 bar
The recommended capacity must be verified on the basis of the actual dimensions of the system implemented

ACCUMULATION AT 60 °C

HEAT EXCHANGER: T.inlet = 80°C; ΔT = 10°C.

STORAGE WATER HEATER: T.inlet =15°C; T.accumulation= 60°C

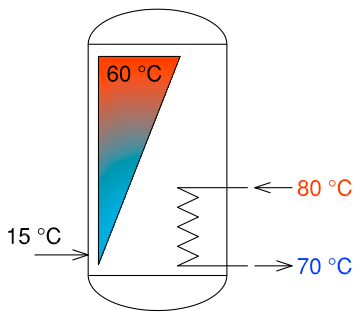

MODEL	THERMAL POWER [kW]	PUMP CAPACITY [l/hour]	HEATING TIME ⁽¹⁾ [min]	PRODUCTION DHW AT 60°C [l/hour]	QUANTITY DHW AT 60°C FOR FIRST 10 min. ⁽²⁾ [l]
BXV-170	26,2	2290	21	500	125
BXV-200	26,2	2290	27	500	125
BXV-250	26,2	2290	33	500	125
BXV-300	26,2	2290	39	500	125
BXV-400	32,7	2865	39	625	156
BXV-500	32,7	2865	46	625	156
BXV-600	52,3	4585	35	1000	250
BXV-800	58,9	5155	42	1125	281
BXV-1000	65,4	5730	47	1250	313
BXV-1500	78,5	6875	59	1500	375

(1) Time required to bring the temperature of the cylinder from 15 °C to 60 °C.

(2) Quantity of DHW (Sanitary Hot Water) at 45°C available in the first 10 minutes with DHW accumulation at 60° C.

ACCUMULATION AT 45 °C

HEAT EXCHANGER: T.inlet = 80°C; ΔT = 10°C.

STORAGE WATER HEATER: T.inlet =15°C; T.accumulation= 45°C

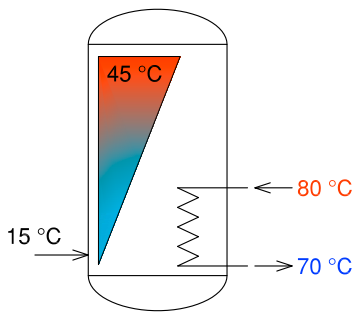

MODEL CYLINDER	THERMAL POWER [kW]	PUMP CAPACITY [l/hour]	HEATING TIME ⁽¹⁾ [min]	PPRODUCTION DHW AT 45°C [l/hour]
BXV-170	31,4	2750	12	900
BXV-200	31,4	2750	15	900
BXV-250	31,4	2750	19	900
BXV-300	31,4	2750	22	900
BXV-400	39,2	3440	22	1125
BXV-500	39,2	3440	26	1125
BXV-600	62,8	5500	20	1800
BXV-800	70,6	6190	24	2025
BXV-1000	78,5	6875	27	2250
BXV-1500	94,2	8250	33	2700

(1) Time required to bring the temperature of the cylinder from 15 °C to 45 °C.

TABLE OF HEATING ELEMENT APPLICABILITY TO CYLINDERS

Heating element model					Water heating time from 15° C to 60 °C (expressed in minutes) <i>The heating times outlined are approximate</i>											
CODE	Power (kW)	Voltage (Volt)	Connection	Length (mm)	BXV-170	BXV-200	BXV-250	BXV-300	BXV-400	BXV-500	BXV-600	BXV-800	BXV-1000	BXV-1500		
8601000	1	220 V / MF	G 1.1/4"	295	543	703	860	1005	1259	1478	1808	2451	3066	4591		
8601650	1.65			450	330	427	522	609	763	896	1096	1486	1859	2783		
8602000	2			515	n.a.	n.a.	n.a.	n.a.	630	739	904	1226	1533	2296		
8602600	2.6			675	n.a.	n.a.	n.a.	n.a.	n.a.	n.a.	n.a.	943	1180	1766		
8602601	2.6			360	209	271	331	387	484	569	696	943	1180	1766		
8603300	3.3			825	n.a.	n.a.	n.a.	n.a.	n.a.	n.a.	n.a.	n.a.	n.a.	n.a.	1392	
8603301	3.3			435	165	214	261	305	484	448	548	743	930	1392		
8604001	4			510	n.a.	n.a.	n.a.	n.a.	n.a.	315	370	452	613	767	1148	
8705000	5			380 V / MF	G 1.1/2"	445	109	141	172	201	252	296	362	491	614	919
8706000	6					510	n.a.	n.a.	n.a.	n.a.	210	247	302	409	511	766
8708000	8	670	n.a.			n.a.	n.a.	n.a.	n.a.	n.a.	n.a.	307	384	574		
8710000	10	820	n.a.			n.a.	n.a.	n.a.	n.a.	n.a.	n.a.	n.a.	n.a.	n.a.	460	

n.a.= Heating element not applicable

HYDRAULIC DIAGRAM 1 (BXV CYLINDER WITH BOILER)

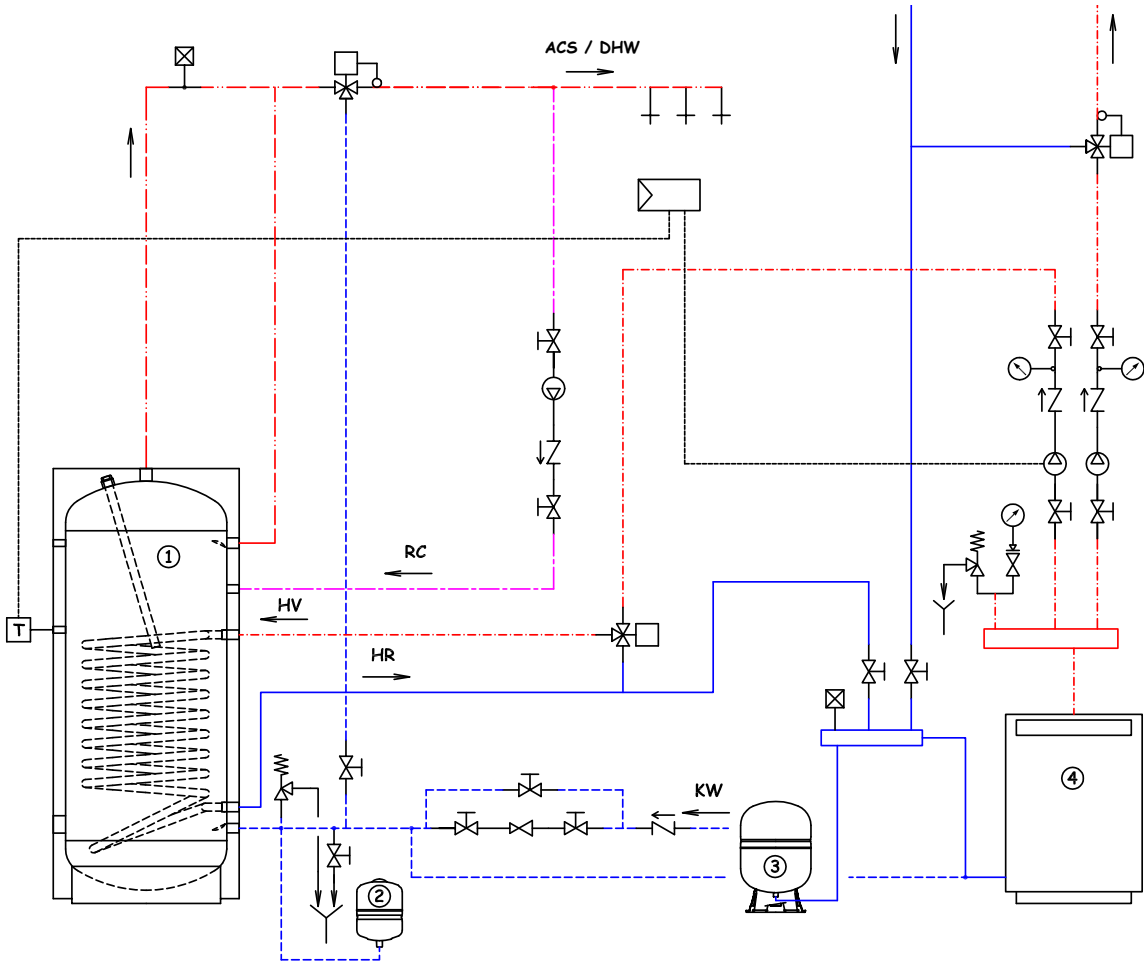

HYDRAULIC DIAGRAM 2 (BXV CYLINDER WITH SOLAR COLLECTOR)

SEE TABLE OF SYMBOLS IN THE SHUTTER OF THE COVER

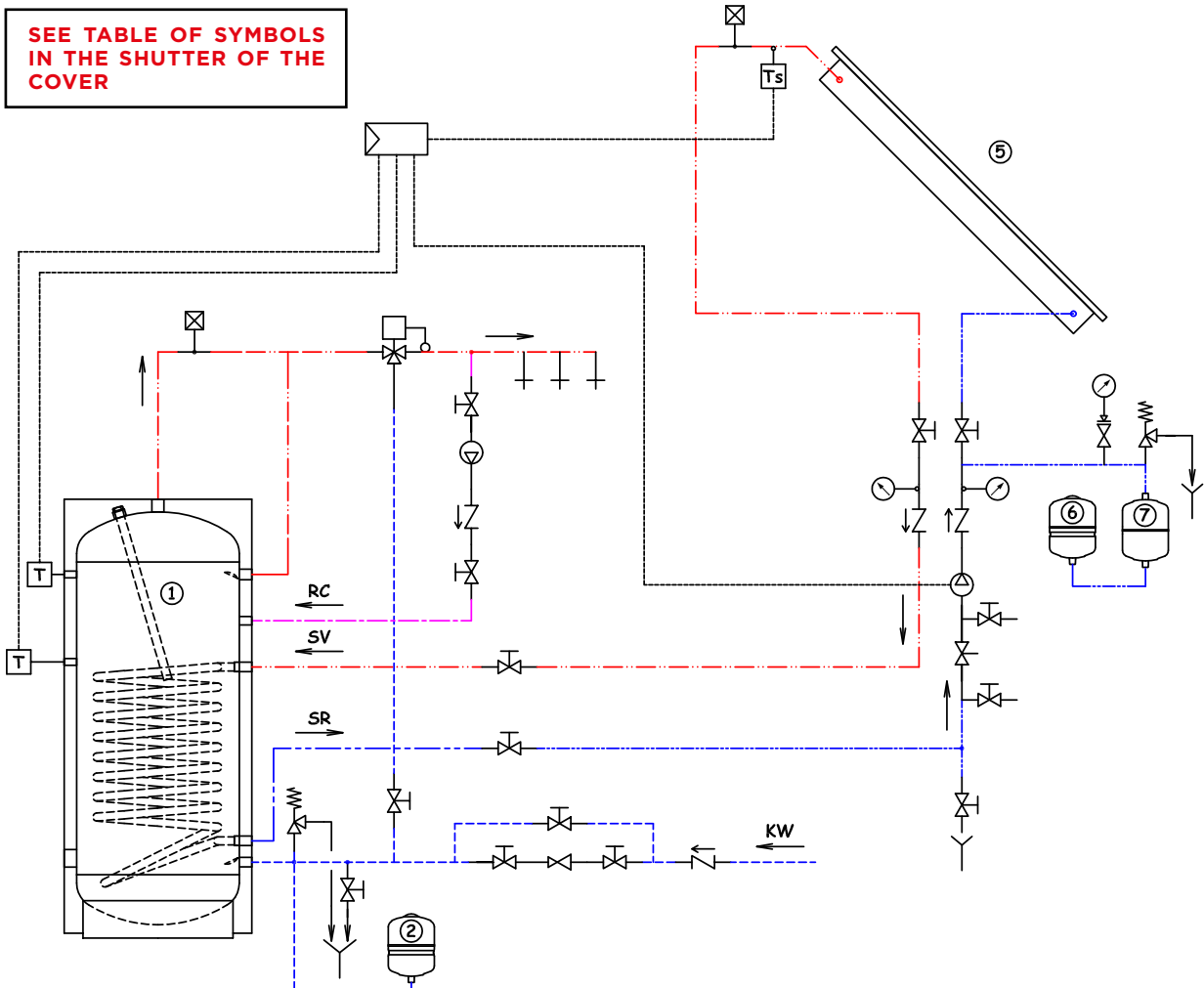





BXP

STAINLESS STEEL DHW CYLINDER WITH FIXED EXCHANGER

FOR HEAT PUMPS (300 - 1000 LITRES)

BXP 300 - 1000

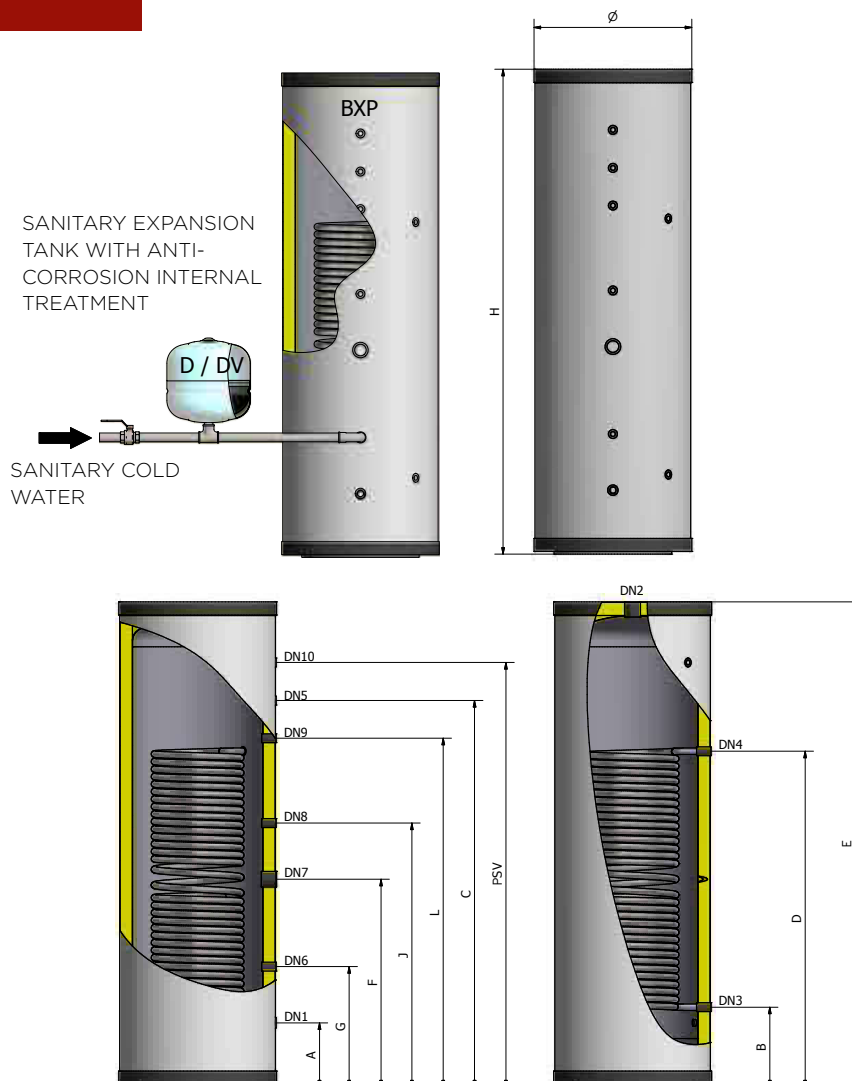

KEYWORD

DN1: Sanitary cold water inlet; **DN2:** Sanitary hot water outlet; **DN3:** Primary fluid outlet, heat exchanger side; **DN4:** Primary fluid inlet, heat exchanger side; **DN5:** Recirculation; **DN6:** Thermostat; **DN7:** Heating element; **DN8:** Thermostat; **DN9:** Probe; **DN10:** T&P Safety valve.

CYLINDER

FOR SANITARY HOT WATER

FOR HEATING PUMPS

STAINLESS STEEL AISI 316 L CASING

POLYURETHANE INSULATION

EXCHANGER IN STAINLESS STEEL AISI 316 L

+ 99°C
CYLINDER
MAX TEMPERATURE

+ 110°C
MAX TEMPERATURE
OF EXCHANGER

P_{MAX} 6 bar
MAX WORKING PRESSURE

P_{SCA} 10 bar
MAX PRESSURE
OF EXCHANGER

REFERENCE STANDARDS

CYLINDER:

2014/68/UE Directive - ART. 4.3 without CE marking
Ecodesign 2009/125/EC, Energy Labelling 2010/30/EU

WARRANTY: 5 YEARS

INSULATION:

Expanded polyurethane without CFC and HCFC
Grey PVC jacket.



HEAT EXCHANGER:

Stainless steel AISI 316L fixed single-tube coil
Models with corrugated pipe.

INSTALLATION:

· heat pumps

DIMENSIONS

MODEL	CODE	ENERGY LABEL		HEAT EXCHANGER				NOTES	
				CL	LITRES				m ²
BXP-300*	A3U0H51 VB005	C		310	4	22	610	1820	
BXP-500*	A3U0H55 VB005	C		460	5	27	710	1820	
BXP-800	A3U0H60 VB005	/		762	6	32	950	2075	
BXP-1000	A3U0H62 VB005	/		960	6	32	990	2375	

*Corrugated pipe

MODEL	A mm	B mm	C mm	D mm	E mm	F mm	G mm	H mm	I mm	PSV mm
BXP-300	215	275	1450	1255	1820	705	430	815	1400	1595
BXP-500	215	275	1450	1255	1820	705	430	815	1400	1595
BXP-800	355	415	1590	1395	2075	845	570	955	1540	1735
BXP-1000	355	415	1645	1395	2375	845	570	955	1540	2035

MODEL	DN 1	DN 2	DN 3	DN 4	DN 5	DN 6	DN 7	DN 8	DN 9	DN 10
BXP-300	3/4" M	3/4"	1"	1" M	3/4"	1/2"	1 1/2"	1/2"	1/2"	1/2"
BXP-500	1"	1"	1"	1" M	3/4"	1/2"	1 1/2"	1/2"	1/2"	1/2"
BXP-800	1 1/2"	1 1/2"	1"	1"	1"	1/2"	1 1/2"	1 1/2"	1/2"	1/2"
BXP-1000	1 1/2"	1 1/2"	1"	1"	1"	1/2"	1 1/2"	1/2"	1/2"	1/2"

TECHNICAL CHARACTERISTICS

MODEL	CYLINDER		HEAT EXCHANGER		PRESSURE DROP
	MAX WORKING PRESSURE	MAX WORKING TEMPERATURE	MAX WORKING PRESSURE	MAX WORKING TEMPERATURE	
BXP-300	6 bar	99 °C	10 bar	110 °C	494
BXP-500					773
BXP-800					1049
BXP-1000					1049

MODEL	INSULATION TYPE	INSULATION THICKNESS	INSULATION DENSITY	INITIAL THERMAL CONDUCTIVITY	(*) INSULATION THERMAL LOSS kWh/24h	EXTERNAL COVER
BXP-300	Rigid polyurethane	50 mm	40 kg/m ³	23,5 mW/m K	1,224	PVC th. 5 mm RAL 9006
BXP-500					1,464	
BXP-800	Flexible polyurethane	100 mm	16 kg/m ³	44,2 mW/m K	3,336	
BXP-1000					3,816	

*Thermal loss calculated with an accumulation temperature equal to 65 °C and with an external temperature equal to 20 °C.

SAFETY DEVICES

- The cylinders must be protected from the effects of over pressure by installing:
- **SAFETY VALVE** calibrated to pressure lower than the max. pressure of the cylinder;
 - **SANITARY EXPANSION TANK** model ELBI **D - DV series**

MODEL	RECOMMENDED SANITARY EXPANSION TANK (mod. ELBI D-DV series)
BXP-300*	D - 24
BXP-500*	D - 35
BXP-800	DV 80
BXP-1000	DV 80

Dimensioning carried out with the following parameters:

T. accumulation = 85 °C / T. inlet = 15 °C / P. pre-charge = 3 bar / P. max = 6 bar

The recommended capacities must be verified on the basis of the actual dimensions of the system implemented.

THERMAL YIELD

ACCUMULATION AT 45 °C

LOW HEAT EXCHANGER: T.inlet = 60°C; $\Delta T = 10^\circ\text{C}$.

STORAGE WATER HEATER: T.inlet = 15°C; T.accumulation = 45°C

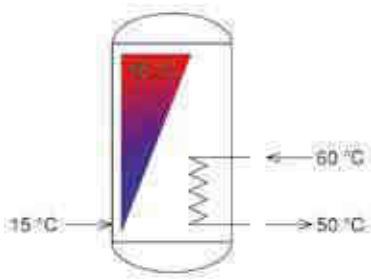

MODEL	THERMAL POWER [kW]	PUMP CAPACITY [l/hour]	HEATING TIME ⁽¹⁾ [min]	PRODUCTION DHW AT 60°C [l/hour]
BXP-300	58,1	5105	12	500
BXP-500	72,7	6380	14	500
BXP-800	87	7660	20	2500
BXP-1000	87	7660	24	2500

(1) Time required to bring the temperature of the cylinder from 15 °C to 45°C

TABLE OF HEATING ELEMENT APPLICABILITY TO CYLINDERS

Heating element model*					Water heating time from 15° C to 60 °C (expressed in minutes) <i>The heating times outlined are approximate</i>			
CODE	Power (kW)	Voltage (Volt)	Connection	Length (mm)	BXP-300	BXP-500	BXP-800	BXP-1000
8601000	1	220 V / MF	G 1,1/4"	295	973	1444	1674	2093
8601650	1,65			675	590	875	1015	1268
8602000	2			360	n.a.	722	837	1047
8602600	2,6			825	375	556	644	805
8603301	3,3			435	295	438	508	634
8604001	4			510	n.a.	361	419	524
8705000	5	380 V / TF	G 1,1/2"	445	195	289	335	419
8706000	6			510	n.a.	241	279	349

SEE TABLE OF SYMBOLS
IN THE SHUTTER OF THE
COVER

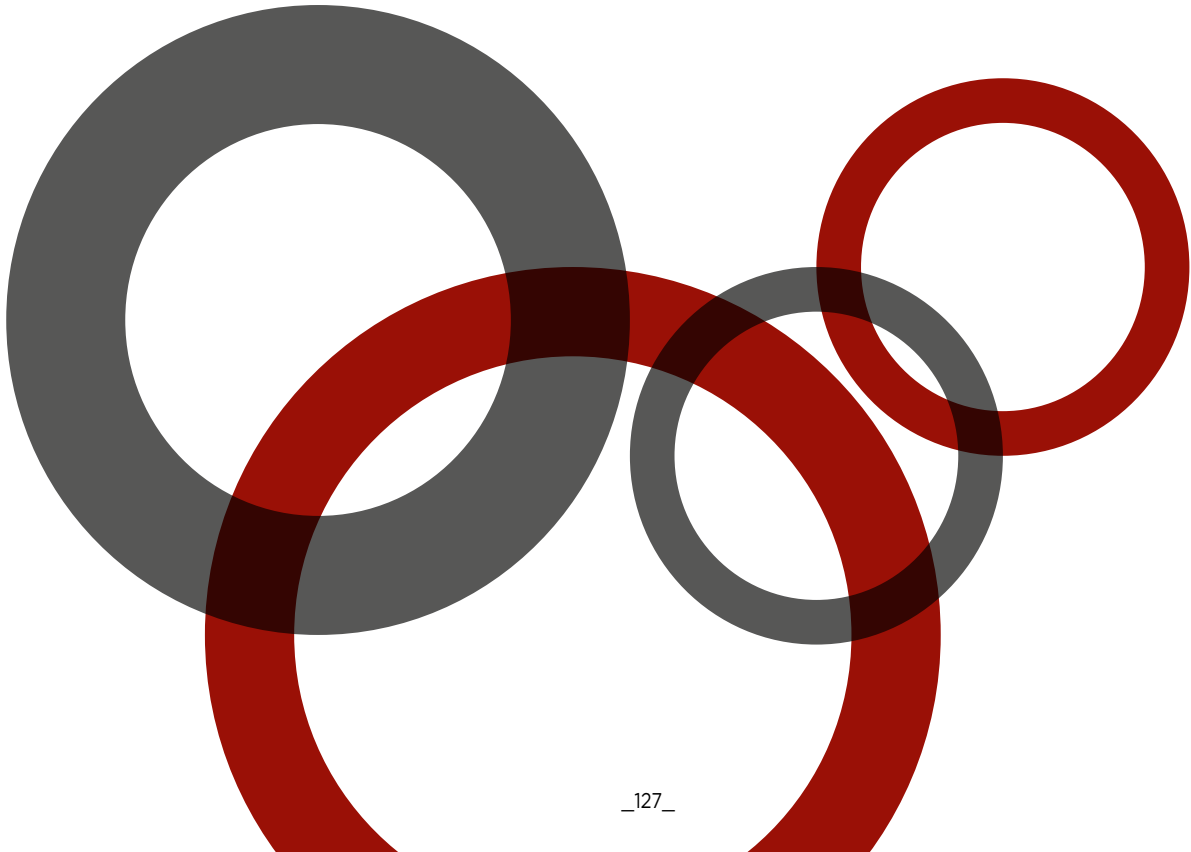
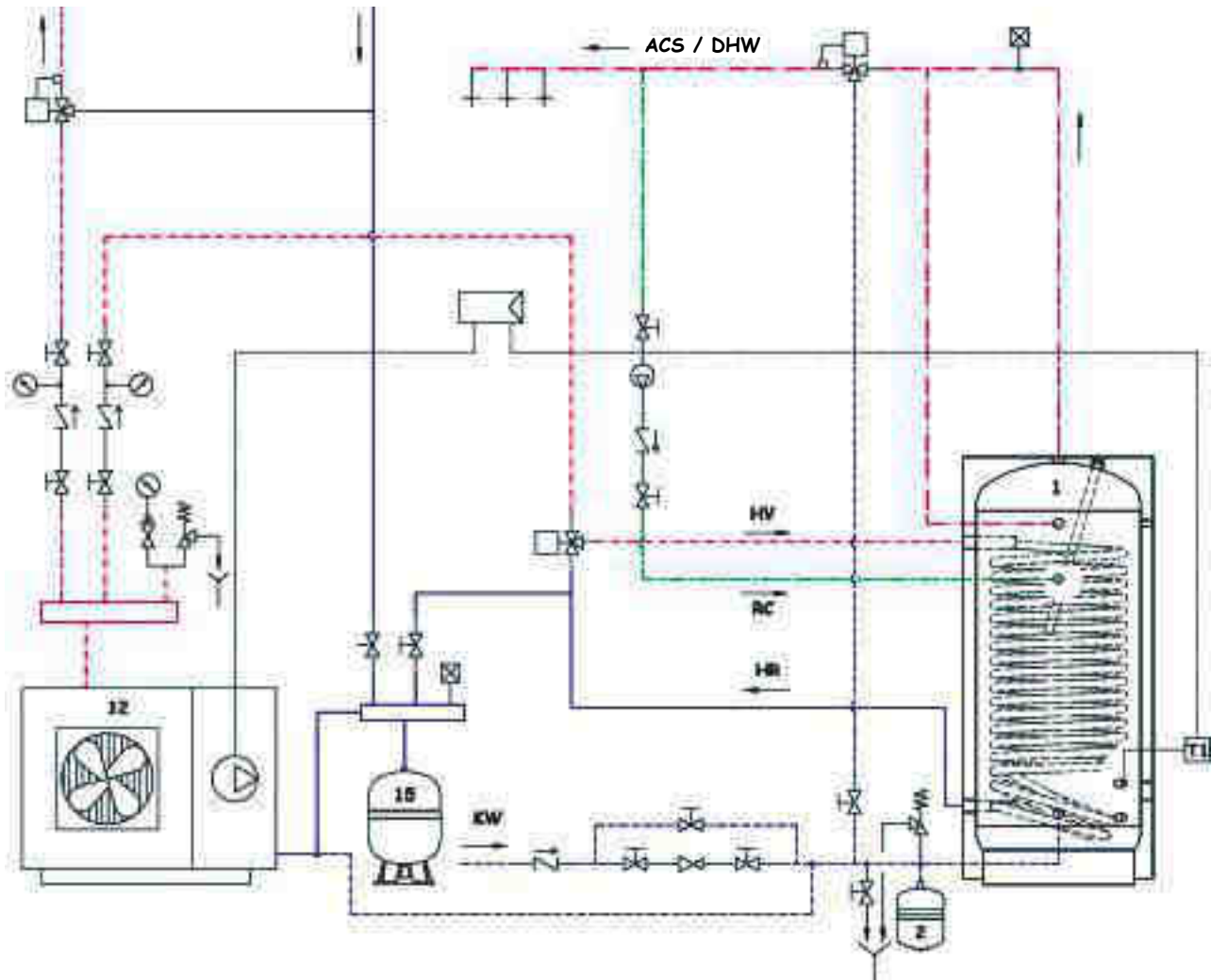



BXT

STAINLESS STEEL CYLINDERS FOR SOLAR THERMAL USE WITH TWO FIXED EXCHANGERS (200 - 1.500 LITRES)

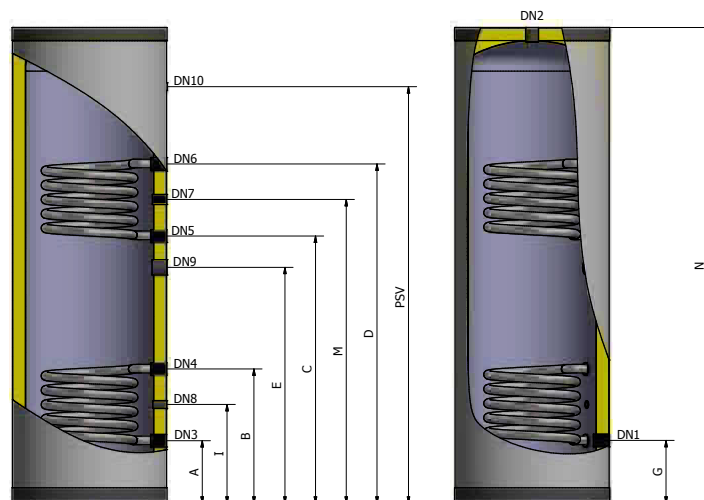
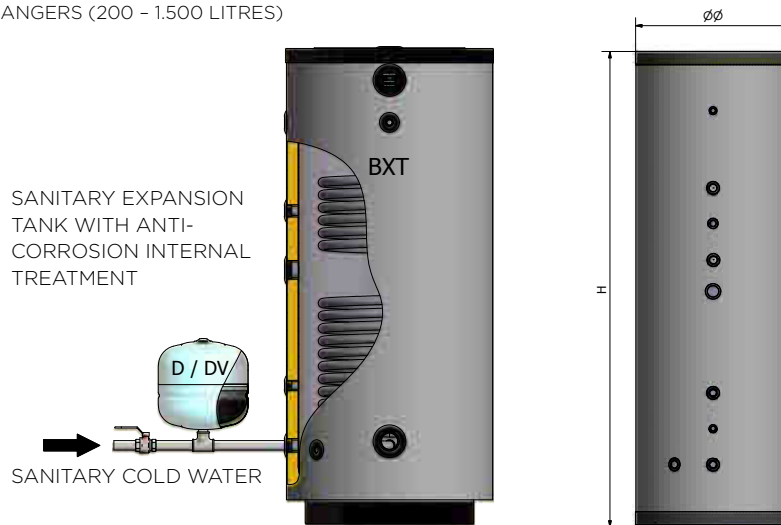

KEYWORD

DN1: Sanitary cold water inlet; **DN2:** Sanitary hot water outlet; **DN3:** Primary fluid outlet, primary heat exchanger side (solar); **DN4:** Primary fluid inlet, primary heat exchanger side (panels); **DN5:** Primary fluid outlet, auxiliary heat exchanger side (boiler); **DN6:** Primary fluid inlet, auxiliary heat exchanger side (boiler); **DN7:** Recirculation; **DN8:** Thermostat; **DN9:** Heating element; **DN10:** T&P Safety valve.

CYLINDER

FOR SANITARY HOT WATER

SUITABLE FOR SOLAR SYSTEMS

STAINLESS STEEL AISI 316 L CASING

POLYURETHANE INSULATION

EXCHANGER IN STAINLESS STEEL AISI 316 L

+ 99°C
CYLINDER
MAX TEMPERATURE

+ 110°C
MAX TEMPERATURE
OF EXCHANGER

P_{MAX} 6 bar
MAX WORKING PRESSURE

P_{SCA} 10 bar
MAX PRESSURE
OF EXCHANGER

REFERENCE STANDARDS

CYLINDER:

2014/68/UE Directive – ART. 4.3, without CE marking
Ecodesign 2009/125/EC, Energy Labelling 2010/30/EU.

WARRANTY: 5 YEARS

INSULATION:

Expanded polyurethane without CFC and HCFC.
White PVC jacket.

HEAT EXCHANGER:

Fixed single-tube coil in stainless steel AISI 316 L
From BXT 200 to BXT 500 models with corrugated pipe.

INSTALLATION:

- solar thermal systems
- traditional boilers (wall-hung and/or floor-standing)
- condensing boilers

DIMENSIONS

MODEL	CODE	ENERGY LABEL	CL	LITRES	STAINLESS STEEL EXCHANGER				mm	mm	NOTES
					LOWER		UPPER				
					m ²	LITRES	m ²	LITRES			
BXT-200*	A3Y0H47 VB005	C	220	1,2	4,1	1,2	4,1	610	1320		
BXT-250*	A3Y0H49 VB005	C	270	1,2	4,1	1,2	4,1	610	1570		
BXT-300*	A3Y0H51 VB005	C	316	1,2	4,1	1,2	4,1	610	1820		
BXT-400*	A3Y0H53 VB005	C	396	1,5	5,1	1,5	5,1	710	1590		
BXT-500*	A3Y0H55 VB005	C	466	1,5	5,1	1,5	5,1	710	1820		
BXT-600	A3Y0H57 VA010	/	570	2,4	12,8	1,5	8,0	850	2010		
BXT-800	A3Y0H60 VA010	/	773	2,7	14,4	2,0	10,7	950	2075		
BXT-1000	A3Y0H62 VA010	/	968	3,0	16,0	2,0	10,7	990	2375		
BXT-1500	A3Y0H67 VA010	/	1453	3,6	19,2	2,0	10,7	1150	2465		

*Corrugated pipe

MODEL	A mm	B mm	C mm	D mm	E mm	G mm	I mm	M mm	N mm	PSV mm
BXT-200	215	495	815	1095	680	215	310	960	1320	1095
BXT-250	215	495	915	1195	790	215	355	1055	1570	1345
BXT-300	215	495	1015	1295	890	215	355	1155	1820	1595
BXT-400	215	495	915	1195	790	215	355	1155	1590	1345
BXT-500	215	495	1015	1295	610	215	355	1155	1820	1595
BXT-600	310	740	1110	1390	985	310	450	1250	2010	1690
BXT-800	355	785	1155	1435	1030	355	495	1295	2075	1735
BXT-1000	355	955	1355	1635	1225	355	555	1495	2375	2035
BXT-1500	425	1025	1425	1705	1295	425	625	1565	2465	2105

MODEL	DN 1	DN 2	DN 3	DN 4	DN 5	DN 6	DN 7	DN 8	DN 9	PSV
BXT-200	1.1/2"	1.1/2"	3/4" M	3/4" M	3/4" M	3/4" M	3/4"	1/2"	1.1/2"	1/2"
BXT-250	1.1/2"	1.1/2"	3/4" M	3/4" M	3/4" M	3/4" M	3/4"	1/2"	1.1/2"	1/2"
BXT-300	1.1/2"	1.1/2"	3/4" M	3/4" M	3/4" M	3/4" M	3/4"	1/2"	1.1/2"	1/2"
BXT-400	1.1/2"	1.1/2"	3/4" M	3/4" M	3/4" M	3/4" M	3/4"	1/2"	1.1/2"	1/2"
BXT-500	1.1/2"	1.1/2"	3/4" M	3/4" M	3/4" M	3/4" M	3/4"	1/2"	1.1/2"	1/2"
BXT-600	1.1/2"	1.1/2"	1"	1"	1"	1"	1"	1/2"	1.1/2"	1/2"
BXT-800	1.1/2"	1.1/2"	1"	1"	1"	1"	1"	1/2"	1.1/2"	1/2"
BXT-1000	1.1/2"	1.1/2"	1"	1"	1"	1"	1"	1/2"	1.1/2"	1/2"
BXT-1500	1.1/2"	1.1/2"	1"	1"	1"	1"	1"	1/2"	1.1/2"	1/2"

TECHNICAL CHARACTERISTICS

MODEL	MAX WORKING PRESSURE CYLINDER (Secondary circuit bar)	MAX. WORKING PRESSURE HEAT EXCHANGER (Primary circuit bar)	HEAT EXCHANGER PRESSURE	
			LOWER EXCHANGER mbar	UPPER EXCHANGER mbar
BXT-200	6	10	1943	1943
BXT-250			1943	1943
BXT-300			1943	1943
BXT-400			2402	2402
BXT-500			2402	2402
BXT-600			1770	2402
BXT-800			2111	1182
BXT-1000			2655	1182
BXT-1500			3935	1182

MODEL	INSULATION TYPE	INSULATION THICKNESS	INSULATION DENSITY	INITIAL THERMAL CONDUCTIVITY	(*) INSULATION THERMAL LOSS kWh/24h	EXTERNAL COVER
BXT-200	Rigid polyurethane	50 mm	40 kg/m ³	23,5 mW/m K	1,584	PVC th. 5 mm RAL 9016
BXT-250					1,800	
BXT-300					1,992	
BXT-400					2,328	
BXT-500					2,592	
BXT-600	Flexible polyurethane	100 mm	16 kg/m ³	44,2 mW/m K	2,736	
BXT-800					3,360	
BXT-1000					3,912	
BXT-1500					5,136	

(*) Thermal loss calculated with an accumulation temperature equal to 65 °C and with an external temperature equal to 20 °C.

SAFETY DEVICES

The cylinders must be protected from the effects of over pressure by installing:

- A **SAFETY VALVE** calibrated to a pressure lower than the max. pressure of the cylinder;
- A **SANITARY EXPANSION TANK** model ELBI **D - DV series**
- A **SOLAR EXPANSION TANK** model ELBI **DS - DSV series**

MODEL	RECOMMENDED EXPANSION TANK	
	SANITARY CIRCUIT (mod. ELBI D-DV series)	LOWER COIL (mod. ELBI DS-DSV series)
BXT-200	D 18	DS 18
BXT-250	D 24	DS 18
BXT-300	D 24	DS 18
BXT-400	D 35	DS 24
BXT-500	D 35	DS 24
BXT-600	DV 50	DS 35
BXT-800	DV 80	DS 35
BXT-1000	DV 80	DSV 50
BXT-1500	DV 150	DSV 80

Sized using the following parameters: T. accumulation= 85 °C / T. inlet = 15 °C / Pre-charge pressure = 3 bar / Max pressure = 6 bar
The recommended capacity must be verified on the basis of the actual dimensions of the system implemented

BXT CYLINDERS ARE SELECTED BASED ON MULTIPLE FACTORS THAT CAN BE BRIEFLY SUMMARISED AS FOLLOWS:

- SANITARY HOT WATER REQUIRED
- SUNLIGHT
- CYLINDER CAPACITY FOR THE NUMBER OF PEOPLE
- SOLAR COLLECTOR SURFACE FOR CYLINDER CAPACITY

SOLAR LIGHT:
LEVEL OF SUNLIGHT PER YEAR IN EUROPE (kWh/m²)

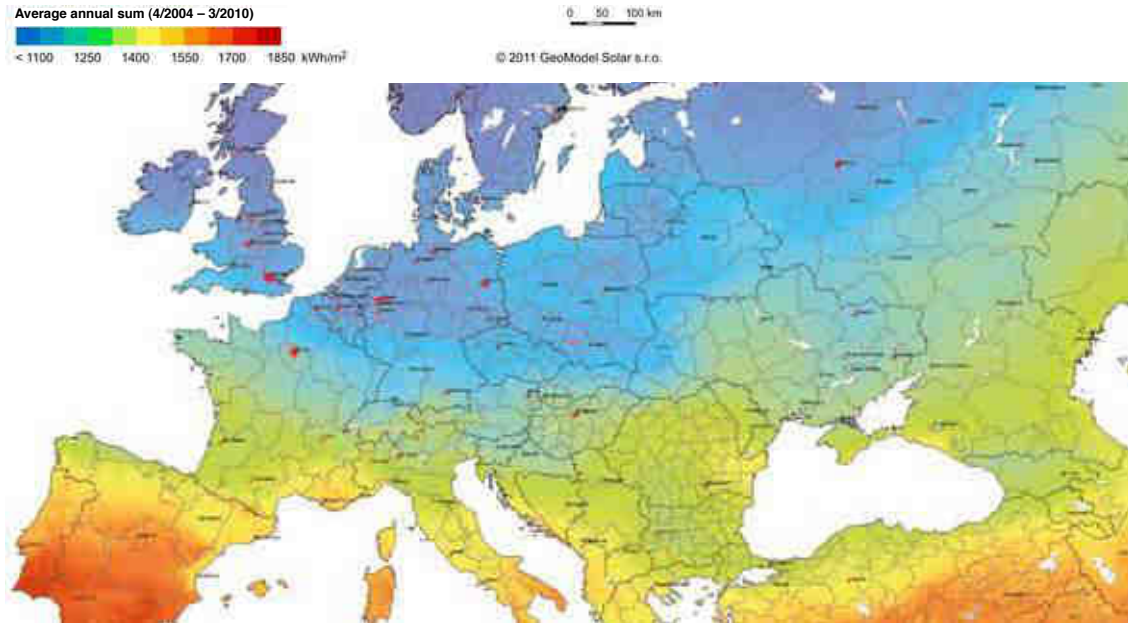

CYLINDER MODELS PER NUMBER OF PEOPLE:

MODEL	Number of people
BXT 200	1 - 2
BXT 300	2 - 4
BXT 400	3 - 5
BXT 500	5 - 7
BXT 800	max. 10
BXT 1000	max. 18
BXT 1500	max. 25

SOLAR COLLECTOR SURFACE TO COMBINE WITH THE SELECTED MODEL:

MODEL	Solar collector surface (m ²)
BXT 200	2.5
BXT 300	5
BXT 400	7.5
BXT 500	10
BXT 800	12.5
BXT 1000	15
BXT 1500	22

TABLE OF HEATING ELEMENT APPLICABILITY TO CYLINDERS

Heating element model*				Water heating time from 15° C to 60 °C (expressed in minutes) <i>The heating times outlined are approximate</i>											
CODE	Power (kW)	Voltage (Volt)	Connection	Length (mm)	BXT-200	BXT-250	BXT-300	BXT-400	BXT-500	BXT-600	BXT-800	BXT-1000	BXT-1500		
8601000	1	220 V / MF	G 1.1/4"	295	691	848	992	1243	1463	1789	2426	3038	4560		
8601650	1,65			450	419	514	601	754	887	1085	1471	1841	2764		
8602000	2			515	n.a.	n.a.	n.a.	622	732	895	1213	1519	2280		
8602600	2.6			675	n.a.	n.a.	n.a.	n.a.	n.a.	n.a.	n.a.	933	1169	1754	
8602601	2.6			360	266	326	382	478	563	688	933	1169	1754		
8603300	3.3			825	n.a.	n.a.	n.a.	n.a.	n.a.	n.a.	n.a.	n.a.	n.a.	1382	
8603301	3.3			435	210	257	301	377	44	543	736	921	1382		
8604001	4			510	n.a.	n.a.	n.a.	311	366	448	607	760	1140		
8705000	5			380 V / TF	G 1.1/2"	445	139	170	199	249	293	358	486	608	912
8706000	6					510	n.a.	n.a.	n.a.	208	244	299	405	507	760
8708000	8	670	n.a.			n.a.	n.a.	n.a.	n.a.	n.a.	304	380	570		
8710000	10	820	n.a.			n.a.	n.a.	n.a.	n.a.	n.a.	n.a.	n.a.	n.a.	456	

n.a. = Heating element not applicable

ACCUMULATION AT 60 °C

LOW HEAT EXCHANGER: T.inlet = 80°C; ΔT = 10°C.

STORAGE WATER HEATER: T.inlet =15°C; T.accumulation= 60°C

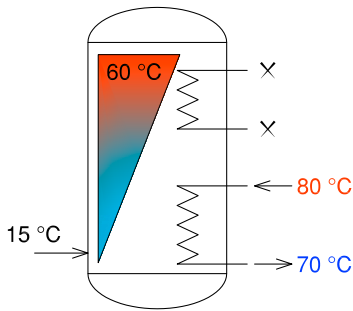

MODEL	THERMAL POWER [kW]	PUMP CAPACITY [l/hour]	HEATING TIME ⁽¹⁾ [min]	PRODUCTION DHW AT 60°C [l/hour]	QUANTITY DHW AT 45°C IN FIRST 10 min. ⁽²⁾ [l]
BXT-200	26,2	2290	27	500	125
BXT-250	26,2	2290	33	500	125
BXT-300	26,2	2290	38	500	125
BXT-400	32,7	2865	38	625	156
BXT-500	32,7	2865	45	625	156
BXT-600	52,3	4585	35	1000	250
BXT-800	58,9	5155	42	1125	281
BXT-1000	65,4	5730	47	1250	313
BXT-1500	78,5	6875	59	1500	375

(1) Time required to bring the temperature of the cylinder from 15 °C to 60 °C.

(2) Quantity of DHW (Sanitary Hot Water) at 45°C available in the first 10 minutes with DHW accumulation at 60° C.

ACCUMULATION AT 60 °C

UP HEAT EXCHANGER: T.inlet = 80°C; ΔT = 10°C.

STORAGE WATER HEATER: T.inlet =15°C; T.accumulation= 60°C

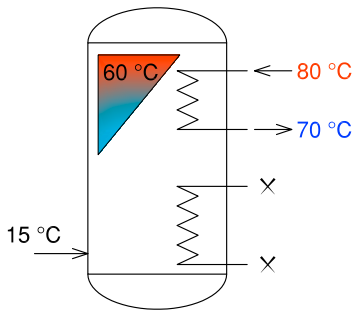

MODEL	THERMAL POWER [kW]	PUMP CAPACITY [l/hour]	HEATING TIME ⁽¹⁾ [min]	PRODUCTION DHW AT 60°C [l/hour]
BXT-200	26,2	2290	27	500
BXT-250	26,2	2290	33	500
BXT-300	26,2	2290	38	500
BXT-400	32,7	2865	38	625
BXT-500	32,7	2865	45	625
BXT-600	32,7	2865	55	625
BXT-800	43,6	3820	56	835
BXT-1000	43,6	3820	70	835
BXT-1500	43,6	3820	105	835

(1) Time required to bring the temperature of the upper part of the cylinder (about 1/3 of the total volume) from 15 °C to 60 °C.

ACCUMULATION AT 60 °C

DOUBLE HEAT EXCHANGER: T.inlet = 80°C; ΔT = 10°C.

STORAGE WATER HEATER: T.inlet =15°C; T.accumulation= 60°C

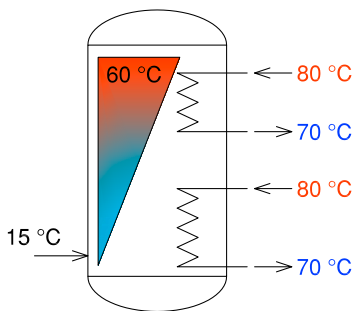

MODEL	THERMAL POWER [kW]	UPPER PUMP CAPACITY [l/hour]	LOWER PUMP CAPACITY [l/hour]	HEATING TIME ⁽¹⁾ [min]	PRODUCTION DHW AT 60°C [l/hour]
BXT-200	52,4	2290	2290	14	1000
BXT-250	52,4	2290	2290	17	1000
BXT-300	52,4	2290	2290	19	1000
BXT-400	65,4	2865	2865	19	1250
BXT-500	65,4	2865	2865	23	1250
BXT-600	85	4585	2865	22	1625
BXT-800	102,5	5155	3820	24	1960
BXT-1000	109	5730	3820	28	2085
BXT-1500	122,1	6875	3820	38	2335

(1) Time required to bring the temperature of the cylinder from 15 °C to 60 °C.

ACCUMULATION AT 45 °C

LOW HEAT EXCHANGER: $T_{inlet} = 80^{\circ}\text{C}$; $\Delta T = 10^{\circ}\text{C}$.

STORAGE WATER HEATER: $T_{inlet} = 15^{\circ}\text{C}$; $T_{accumulation} = 45^{\circ}\text{C}$

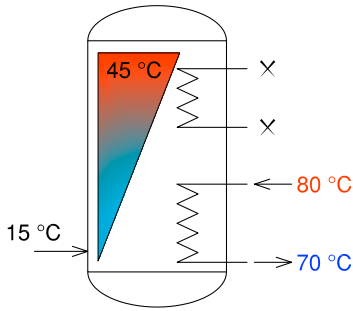

MODEL	THERMAL POWER [kW]	PUMP CAPACITY [l/hour]	HEATING TIME ⁽¹⁾ [min]	PRODUCTION DHW AT 45°C [l/hour]
BXT-200	31,4	2750	15	900
BXT-250	31,4	2750	18	900
BXT-300	31,4	2750	22	900
BXT-400	39,2	3440	22	1125
BXT-500	39,2	3440	25	1125
BXT-600	62,8	5500	19	1800
BXT-800	70,6	6190	23	2025
BXT-1000	78,5	6875	26	2250
BXT-1500	94,2	8250	33	2700

(1) Time required to bring the temperature of the cylinder from 15 °C to 45 °C.

ACCUMULATION AT 45 °C

UP HEAT EXCHANGER: $T_{inlet} = 80^{\circ}\text{C}$; $\Delta T = 10^{\circ}\text{C}$.

STORAGE WATER HEATER: $T_{inlet} = 15^{\circ}\text{C}$; $T_{accumulation} = 45^{\circ}\text{C}$

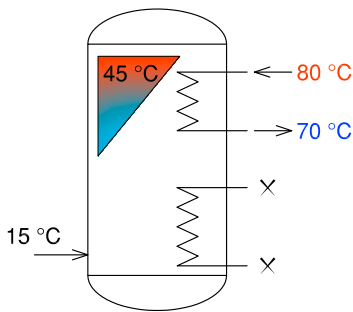

MODEL	THERMAL POWER [kW]	PUMP CAPACITY [l/hour]	HEATING TIME ⁽¹⁾ [min]	PRODUCTION DHW AT 45°C [l/hour]
BXT-200	31,4	2750	15	900
BXT-250	31,4	2750	18	900
BXT-300	31,4	2750	22	900
BXT-400	39,2	3440	22	1125
BXT-500	39,2	3440	25	1125
BXT-600	39,2	3440	31	1125
BXT-800	52,3	4585	31	1500
BXT-1000	52,3	4585	39	1500
BXT-1500	52,3	4585	59	1500

(1) Time required to bring the temperature of the cylinder (about 1/3 of the total volume) from 15 °C to 45°C.

ACCUMULATION AT 45 °C

DOUBLE HEAT EXCHANGER: $T_{inlet} = 80^{\circ}\text{C}$; $\Delta T = 10^{\circ}\text{C}$.

STORAGE WATER HEATER: $T_{inlet} = 15^{\circ}\text{C}$; $T_{accumulation} = 45^{\circ}\text{C}$

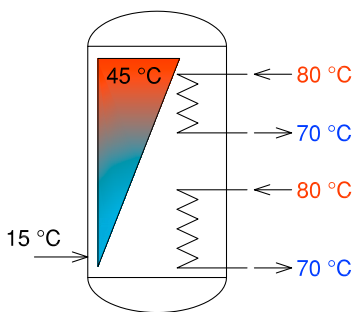

MODEL	THERMAL POWER [kW]	UPPER PUMP CAPACITY [l/hour]	LOWER PUMP CAPACITY [l/hour]	HEATING TIME ⁽¹⁾ [min]	PRODUCTION DHW AT 45°C [l/hour]
BXT-200	62,8	2750	2750	8	1800
BXT-250	62,8	2750	2750	9	1800
BXT-300	62,8	2750	2750	11	1800
BXT-400	78,4	3440	3440	11	2250
BXT-500	78,4	3440	3440	13	2250
BXT-600	102,0	5500	3440	12	2925
BXT-800	122,9	6190	4585	16	3525
BXT-1000	130,8	6875	4585	20	3750
BXT-1500	146,5	8250	4585	21	4200

(1) Time required to bring the temperature of the cylinder from 15 °C to 45°C.

HYDRAULIC DIAGRAM 1 (BXT CYLINDER WITH SOLAR CIRCUIT AND INTEGRATION)

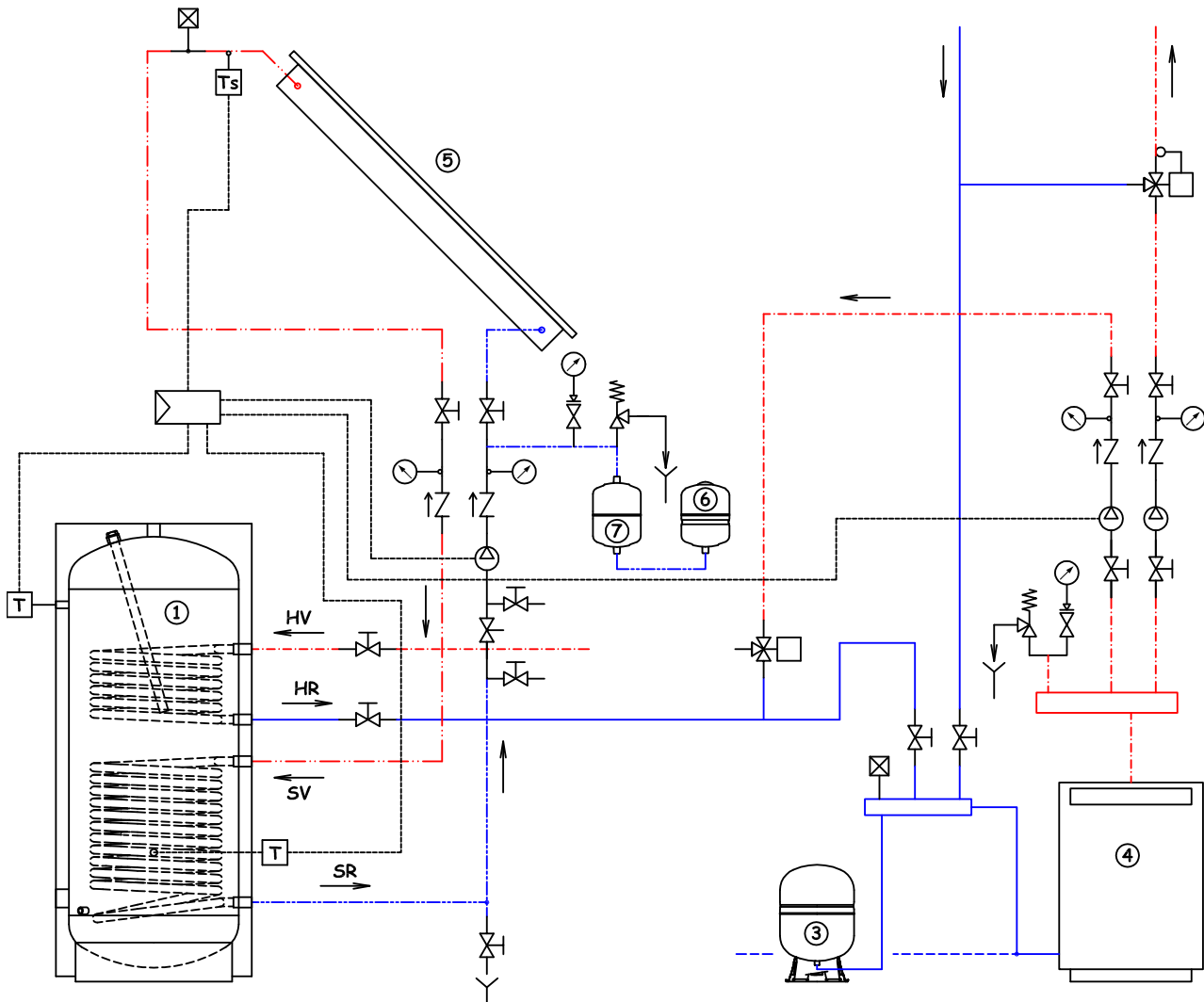

HYDRAULIC DIAGRAM 2 (BXT CYLINDER WITH SANITARY CIRCUIT)

SEE TABLE OF SYMBOLS
IN THE SHUTTER OF THE
COVER

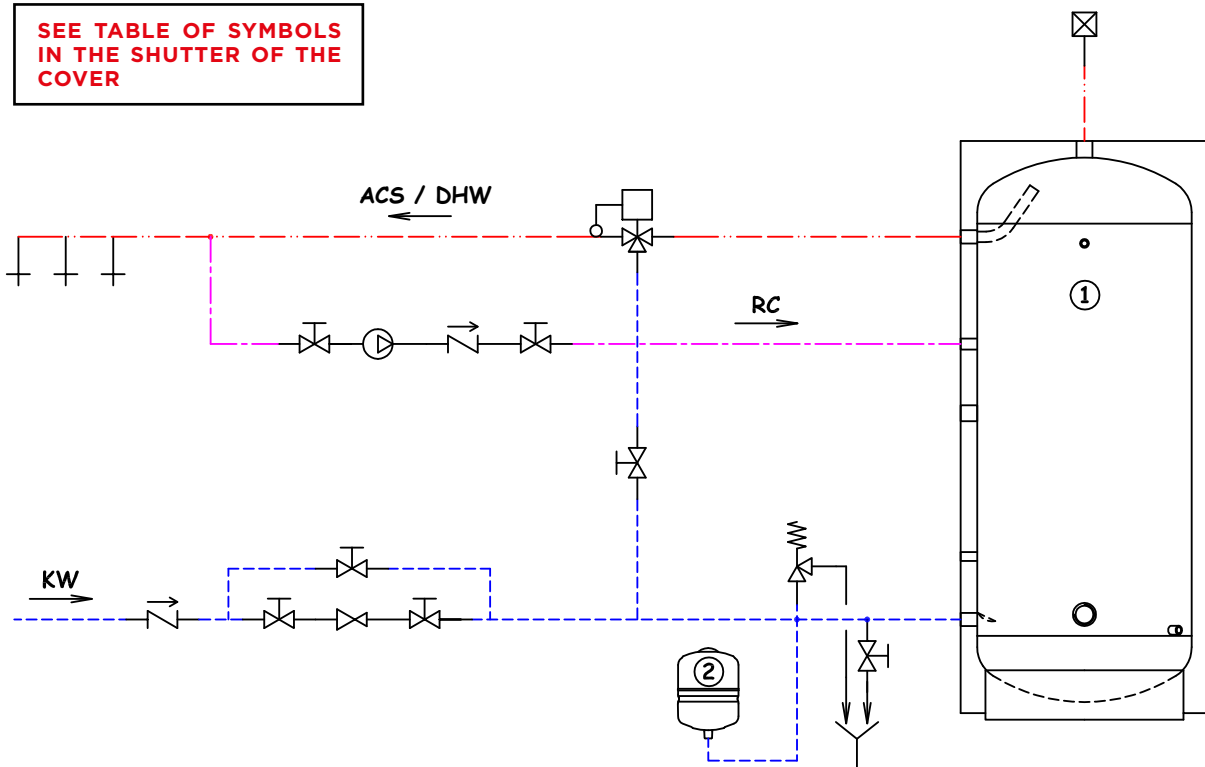

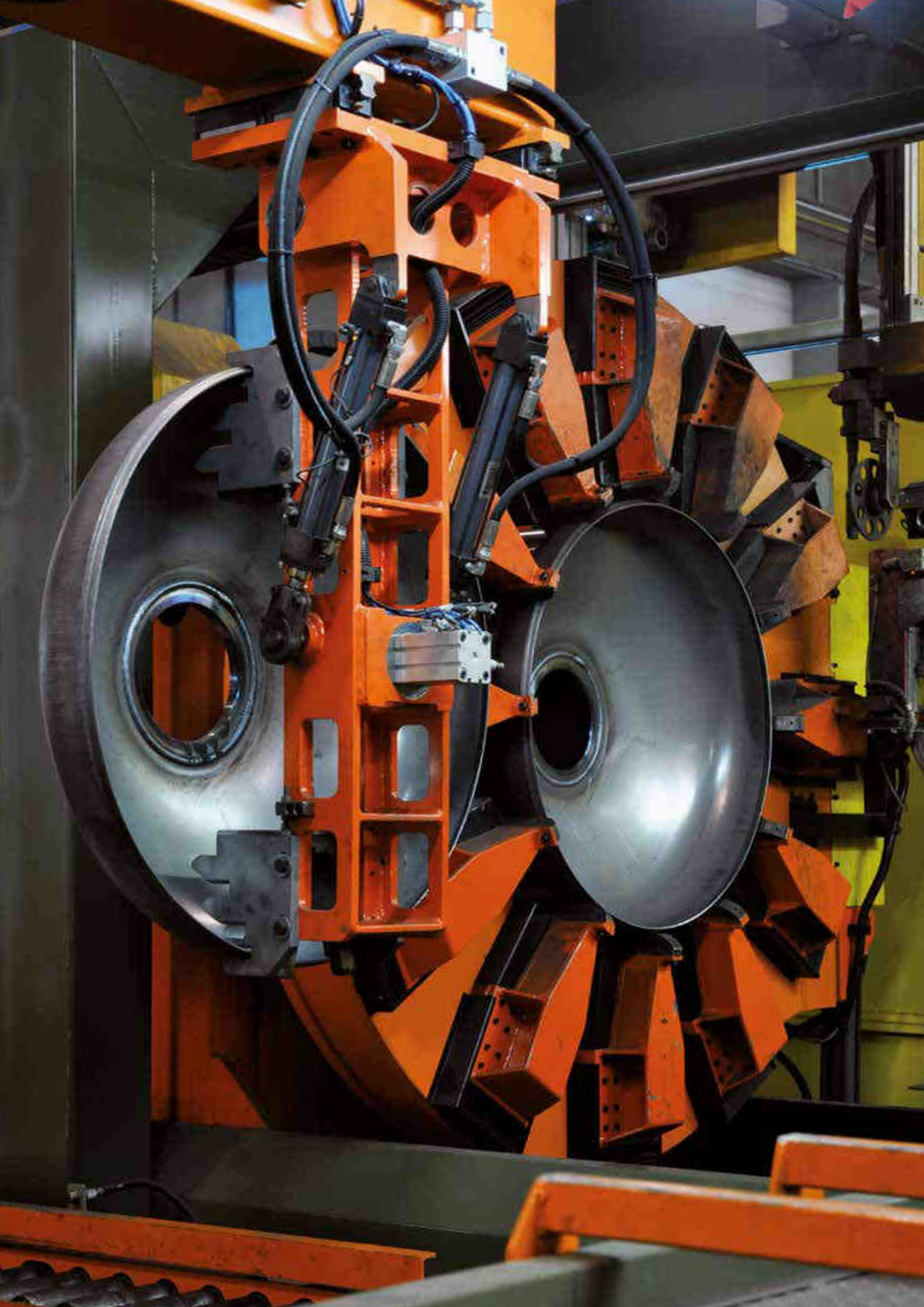



BXPT

STAINLESS STEEL DHW CYLINDER

WITH TWO FIXED EXCHANGERS FOR HEAT PUMPS (300 - 1.000 LITRES)

BXPT 300-1000

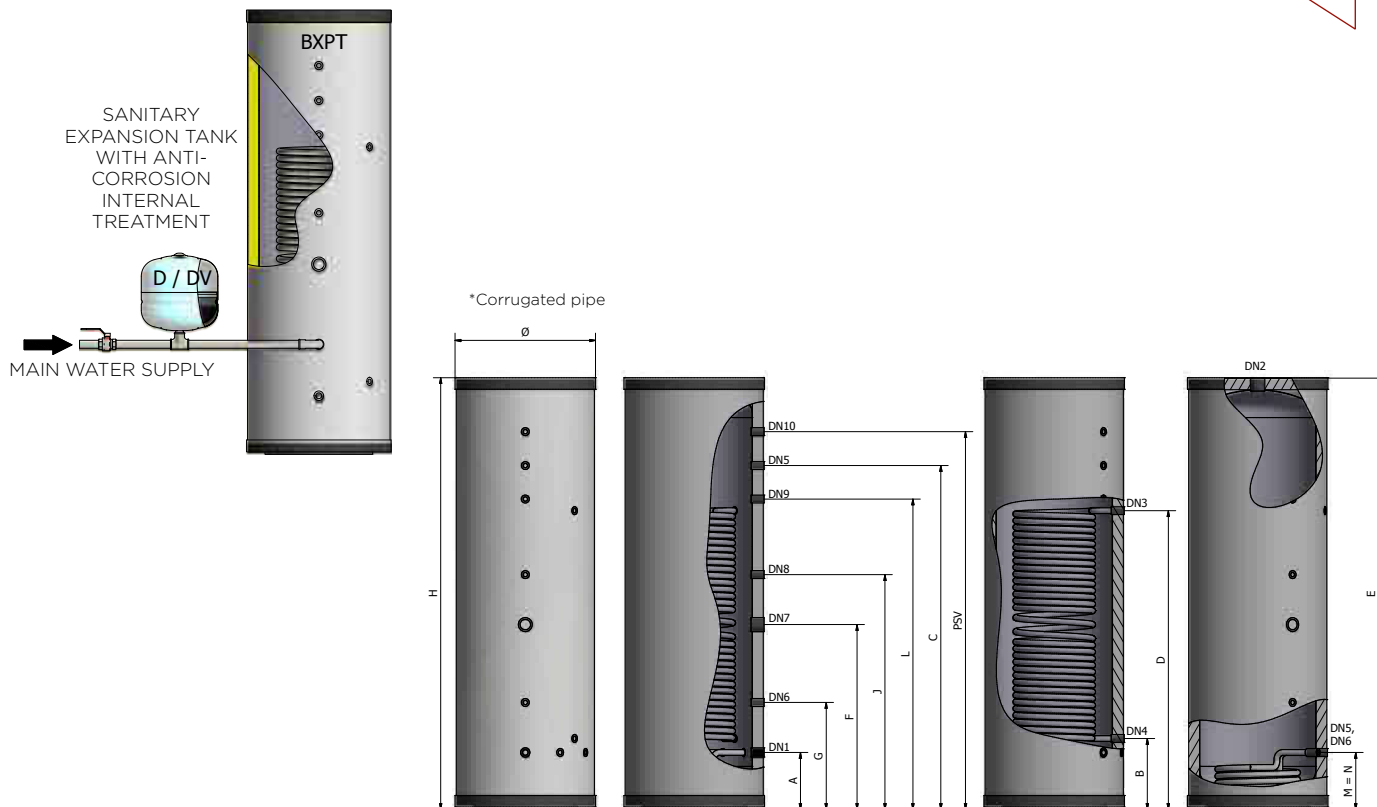

KEYWORD

DN1: Sanitary cold water inlet; **DN2:** Sanitary hot water outlet; **DN3:** Primary to heating pump; **DN4:** Primary from heating pump; **DN5:** Primary to integration; **DN6:** Primary from integration; **DN7:** Heating element; **DN8:** Thermostat; **DN9:** Probe; **DN10:** T&P Safety valve

CYLINDER

FOR SANITARY HOT WATER

POLYURETHANE INSULATION

FOR HEATING PUMP

STAINLESS STEEL BODY

STAINLESS STEEL COIL

+ 99°C

CYLINDER
MAX TEMPERATURE

+ 110°C

MAX TEMPERATURE OF
EXCHANGER

P_{MAX} 6 bar
MAX WORKING PRESSURE

P_{SCA} 10 bar
HEAT EXCHANGER MAX PRESSURE

REFERENCE STANDARDS

CYLINDER:

2014/68/UE Directive - ART. 4.3 without CE marking
Ecodesign 2009/125/EC, Energy Labelling 2010/30/EU

WARRANTY: 5 YEARS

INSULATION:

Expanded polyurethane without CFC and HCFC
Grey PVC jacket

HEAT EXCHANGER:

Two fixed mono-tube coil in stainless steel AISI 316 L

INSTALLATION:

· heat pumps

DIMENSIONS

MODEL	CODE	ENERGY LABEL	STAINLESS STEEL EXCHANGER								NOTES
			CL	LITRES	UPPER		LOWER		mm	mm	
					m ²	LITRES	m ²	LITRES			
BXPT- 300*	A3U2H51 VB005	C	315	4	22	0,7	2,4	610	1820		
BXPT- 500*	A3U2H55 VB005	C	460	5	27	0,9	3,2	710	1820		
BXPT- 800	A3U2H60 VB005	/	754	6	32	1,5	8	950	2075		
BXPT- 1000	A3U2H62 VB005	/	952	6	32	1,5	8	990	2375		

*Corrugated pipe

MODEL	DN 1	DN 2	DN 3	DN 4	DN 5	DN 6	DN 7	DN 8	DN 9	PSV
BXPT-300	1 1/2"	1/2"	1"	1" M	3/4" M	3/4" M	3/4"	1 1/2"	3/4"	1/2"
BXPT-500	1 1/2"	1/2"	1"	1" M	3/4" M	3/4" M	3/4"	1 1/2"	3/4"	1/2"
BXPT-800	1 1/2"	1/2"	1"	1"	1"	1"	1"	1 1/2"	1"	1/2"
BXPT-1000	1 1/2"	1/2"	1"	1"	1"	1"	1"	1 1/2"	1"	1/2"

NODELLO	A mm	B mm	C mm	D mm	E mm	F mm	G mm	J mm	L mm	M mm	N mm	PSV mm
BXPT-300	215	275	1450	1255	1820	705	430	815	1400	215	215	1595
BXPT-500	215	275	1450	1255	1820	705	430	815	1400	215	215	1595
BXPT-800	355	415	1590	1395	2075	845	570	955	1540	355	355	1735
BXPT-1000	355	415	1645	1395	2375	845	570	955	1540	355	355	2035

TECHNICAL CHARACTERISTICS

MODEL	MAX WORKING PRESSURE CYLINDER (Secondary circuit bar)	MAX. WORKING PRESSURE HEAT EXCHANGER (Primary circuit bar)	HEAT EXCHANGER PRESSURE			
			LOWER EXCHANGER		UPPER EXCHANGER	
BXPT-300	6 bar	10 bar	638 mbar		336 mbar	
BXPT-500			1198 mbar		336 mbar	
BXPT-800			1049 mbar		336 mbar	
BXPT-1000			1049 mbar		520 mbar	

MODEL	INSULATION TYPE	INSULATION THICKNESS	INSULATION DENSITY	INITIAL THERMAL CONDUCTIVITY	(*) INSULATION THERMAL LOSS	EXTERNAL COVER
BXPT-300	Rigid polyurethane	50 mm	40 kg/m ³	23,5 mW/m K	2,208 kWh / 24h	PVC 5 mm RAL 9006
BXPT-500					2,688 kWh / 24h	
BXPT-800					3,432 kWh / 24h	
BXPT-1000	Flexible polyurethane	100 mm	16 kg/m ³	44,2 mW/m K	3,912 kWh / 24h	

(*) Thermal loss calculated with an accumulation temperature equal to 65 °C and with an external temperature equal to 20 °C.

SAFETY DEVICES

- The cylinders must be protected from the effects of over pressure by installing:
- A **SAFETY VALVE** calibrated to a pressure lower than the max. pressure of the cylinder;
 - A **SANITARY EXPANSION TANK** model ELBI **D - DV series**

RECOMMENDED EXPANSION TANK

MODEL	SANITARY CIRCUIT (mod. ELBI D-DV series)	LOWER COIL (mod. ELBI DS-DSV series)
BXPT-300	D - 24	DS - 35
BXPT-500	D - 35	DSV - 50
BXPT-800	DV - 50	DSV - 80
BXPT-1000	DV - 80	DSV - 80

Sized using the following parameters: T. accumulation= 85 °C / T. inlet = 15 °C / Pre-charge pressure = 3 bar / Max pressure = 6 bar
The recommended capacity must be verified on the basis of the actual dimensions of the system implemented

ACCUMULATION AT 45 °C

EXCHANGER: T.inlet = 60°C; ΔT = 10°C.

STORAGE WATER HEATER: T.inlet =15°C; T.accumulation = 45°C

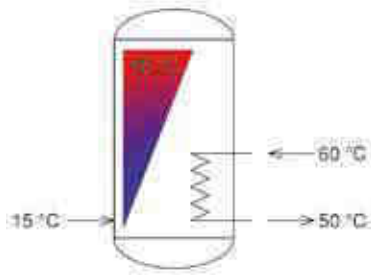

MODEL	THERMAL POWER [kW]	PUMP CAPACITY [lt/h]	HEATING TIME ⁽¹⁾ [min]	PRODUCTION ACS AT 45°C [lt/h]
BXPT 300	32	2810	20	920
BXPT 500	72,7	6380	14	2085
BXPT 800	87	7660	20	2500
BXPT 1000	87	7660	24	2500

(1) Time required to bring the temperature of the cylinder from 15 °C to 45 °C

ACCUMULATION AT 45 °C

UPPER EXCHANGER: T.inlet = 80°C; ΔT = 10°C.

STORAGE WATER HEATER: T.inlet =15°C; T.accumulation = 45°C

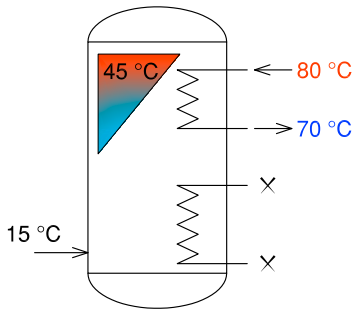

MODEL	THERMAL POWER [kW]	PUMP CAPACITY [lt/h]	HEATING TIME ⁽¹⁾ [min]	PRODUCTION ACS AT 45°C [lt/h]
BXPT 300	18,3	1605	35	525
BXPT 500	23,6	2065	45	675
BXPT 800	39,3	3440	43	1125
BXPT 1000	39,3	3440	54	1125

(1) Time required to bring the temperature of the upper part of the cylinder (about 1/3 of the total volume) from 15 °C to 45 °C

ACCUMULATION AT 45 °C

DOUBLE EXCHANGER: T.inlet = 80°C; ΔT = 10°C.

STORAGE WATER HEATER: T.inlet =15°C; T.accumulation = 45°C

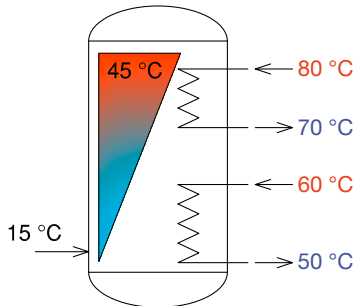

MODEL	THERMAL POWER [kW]	PUMP CAPACITY [lt/h]	HEATING TIME ⁽¹⁾ [min]	PRODUCTION ACS AT 45°C [lt/h]	PRODUCTION DHW AT 45°C [l/hour]
BXPT 300	50,3	2810	1605	13	1440
BXPT 500	96,2	6380	2065	11	2760
BXPT 800	126,5	7660	3440	14	3625
BXPT 1000	126,5	7660	3440	17	3625

(1) Time required to bring the temperature of the cylinder from 15 °C to 45 °C

ACCUMULATION AT 60 °C

UPPER EXCHANGER: T.inlet = 80°C; ΔT = 10°C.

STORAGE WATER HEATER: T.inlet =15°C; T.accumulation = 45°C

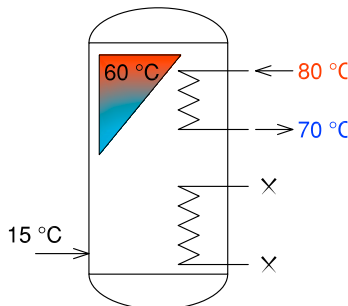

MODEL	THERMAL POWER [kW]	PUMP CAPACITY [lt/h]	HEATING TIME ⁽¹⁾ [min]	PRODUCTION ACS AT 45°C [lt/h]	QUANTITY DHW AT 45°C IN FIRST 10 min
BXPT 300	15,3	1335	62	440	73
BXPT 500	19,6	1720	80	565	94
BXPT 800	32,7	2865	77	940	156
BXPT 1000	32,7	2865	96	940	156

(1) Time required to bring the temperature of the upper part of the cylinder (about 1/3 of the total volume) from 15 °C to 60 °C.

TABLE OF HEATING ELEMENT APPLICABILITY TO CYLINDERS

Heating element model					Water heating time from 15° C to 60° C (expressed in minutes) <i>The heating times outlined are approximate</i>			
CODE	Power (kW)	Voltage (Volt)	Connection	Length (mm)	BXPT-300	BXPT-500	BXPT-800	BXPT-1000
8601000	1	220 V / MF	G 1.1/4"	295	973	1444	1674	2093
8601650	1.65	220 V / MF	G 1.1/4"	450	590	875	1015	1268
8602000	2	220 V / MF	G 1.1/4"	515	n.a.	722	837	1047
8602600	2.6	220 V / MF	G 1.1/4"	360	375	556	644	805
8603301	2.6	220 V / MF	G 1.1/4"	435	295	438	508	634
8604001	3.3	220 V / MF	G 1.1/4"	510	n.a.	361	419	524
8705000	3.3	380 V / MF	G 1.1/2"	445	195	289	335	419
8706000	4	380 V / MF	G 1.1/2"	510	n.a.	241	279	349

n.a.= Heating element not applicable

HYDRAULIC DIAGRAM KETTLE BXPT HEAT PUMP CIRCUIT - SOLAR

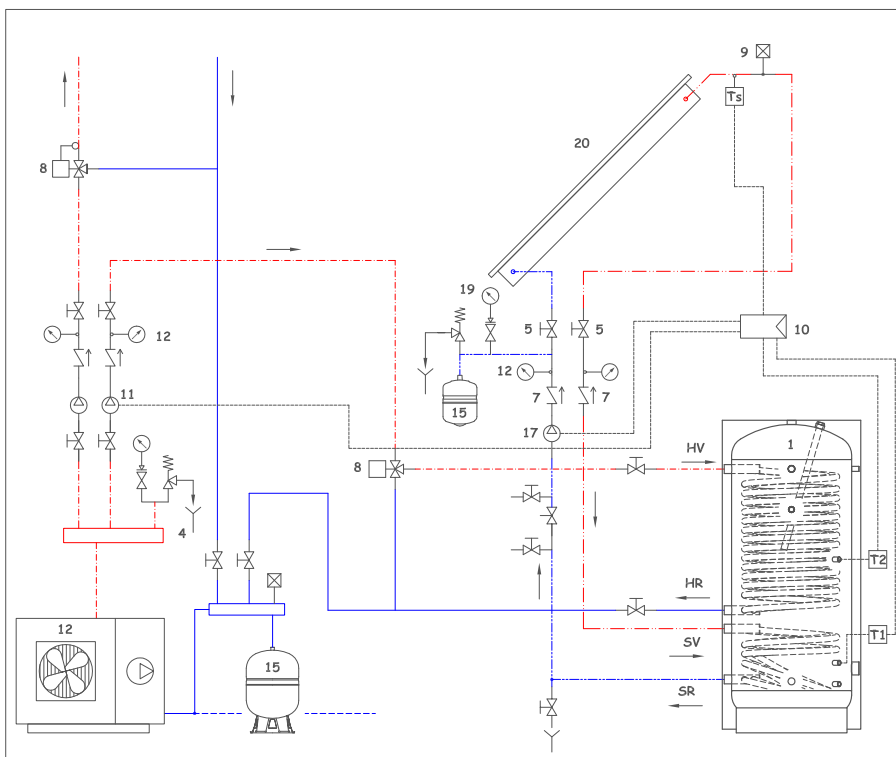

HYDRAULIC DIAGRAM KETTLE BXPT HEALTH CIRCUIT

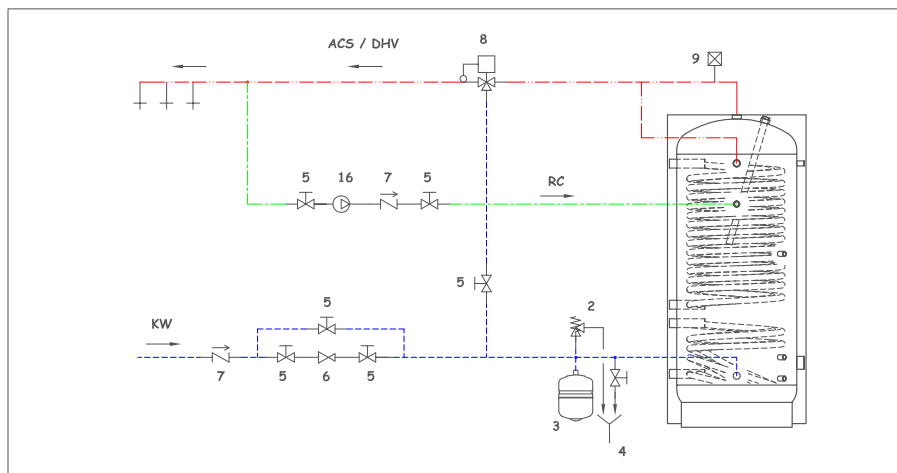



SXC

STAINLESS STEEL ACCUMULATORS FOR TECHNICAL HOT WATER (100 - 900 LITRES)

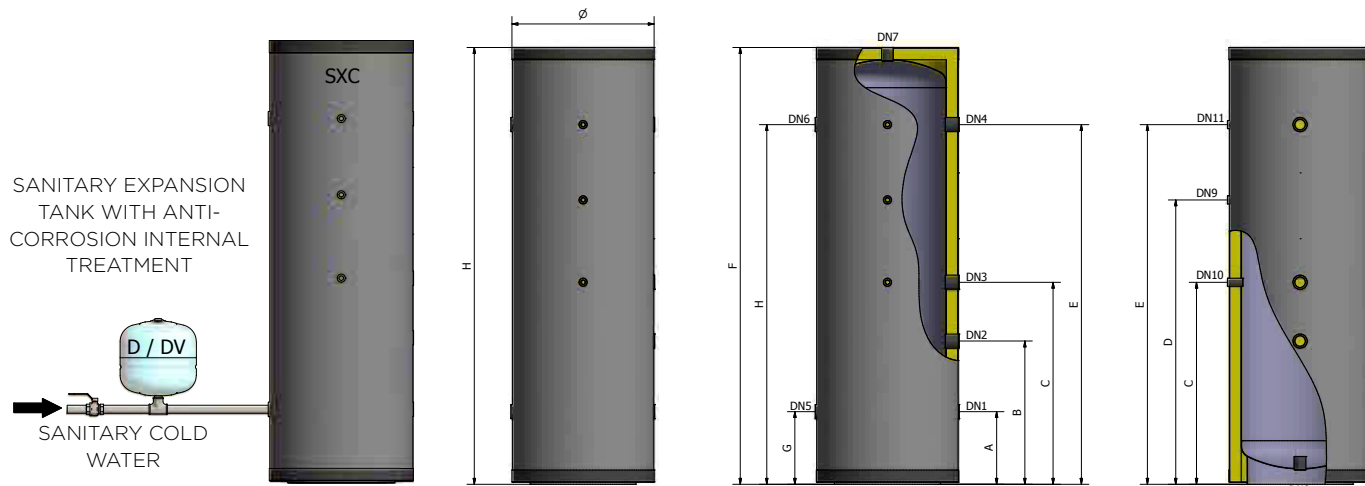

KEYWORD

DN1: Primary delivery (hot water to external exchanger); **DN2:** Return from underfloor heating; **DN3:** Delivery to floor system; **DN4:** Primary return (hot water from the external heat exchanger); **DN5:** Return from heating system; **DN6:** Delivery to heating system; **DN7:** Auxiliary / vent; **DN8:** Drain; **DN9:** Probe; **DN10:** Probe; **DN11:** Probe



FOR HEATING SYSTEMS



HANDLING BY FORKLIFT



POLYURETHANE INSULATION



HOT WATER STORAGE TANK



FOR CHILLED WATER



+ 99°C
CYLINDER
MAX TEMPERATURE

P_{MAX} 3 bar
MAX WORKING PRESSURE

REFERENCE STANDARDS ACCUMULATOR:

2014/68/UE Directive - ART. 4.3 without CE marking
Ecodesign 2009/125/EC, Energy Labelling 2010/30/EU

WARRANTY: 5 YEARS



INSULATION:

EXPANDED POLYURETHANE

INSTALLATION:

- traditional boilers (wall-hung and/or floor-standing)
- condensing boilers
- solar thermal systems
- heat pumps
- air conditioning systems

DIMENSIONS

MODEL	CODE	ENERGY LABEL CL	 LITRI	 mm	 mm	L mm	NOTES
SXC-100	A3LOE38 VD007	A	100	540	985	--	
SXC-200	A3LOE47 VD007	A	185	640	1180	--	
SXC-300	A3LOE51 VD007	B	288	690	1430	--	
SXC-500	A3LOE55 VD007	C	484	740	1960	--	
SXC-600	A3LOE57 VD007	C	576	790	1970	--	
SXC-800	A3LOE60 VD007	/	804	890	2060	--	
SXC-900	A3LOE61 VD007	/	855	930	2060	--	

MODEL	A mm	B mm	C mm	D mm	E mm	F mm	G mm	H mm
SXC-100	250	--	500	--	755	985	250	755
SXC-200	265	--	490	--	935	1180	265	935
SXC-300	275	430	580	886	1195	1430	275	1195
SXC-500	300	530	760	1210	1680	1960	300	1680
SXC-600	330	560	790	1240	1710	1970	330	1710
SXC-800	340	570	840	1290	1720	2060	340	1720
SXC-900	340	570	890	1340	1720	2060	340	1720

MODEL	DN 1	DN 2	DN 3	DN 4	DN 5	DN 6	DN 7	DN 8	DN 9	DN 10	DN 11
SXC-100	1.1/4"	1.1/4"	1.1/4"	1.1/4"	1.1/4"	1.1/4"	1.1/4"	1"	1/2"	1/2"	1/2"
SXC-200	1.1/4"	1.1/4"	1.1/4"	1.1/4"	1.1/4"	1.1/4"	1.1/4"	1"	1/2"	1/2"	1/2"
SXC-300	1.1/4"	1.1/4"	1.1/4"	1.1/4"	1.1/4"	1.1/4"	1.1/4"	1"	1/2"	1/2"	1/2"
SXC-500	1.1/4"	1.1/4"	1.1/4"	1.1/4"	1.1/4"	1.1/4"	1.1/4"	1"	1/2"	1/2"	1/2"
SXC-600	1.1/4"	1.1/4"	1.1/4"	1.1/4"	1.1/4"	1.1/4"	1.1/4"	1"	1/2"	1/2"	1/2"
SXC-800	1.1/4"	1.1/4"	1.1/4"	1.1/4"	1.1/4"	1.1/4"	1.1/4"	1"	1/2"	1/2"	1/2"
SXC-900	1.1/4"	1.1/4"	1.1/4"	1.1/4"	1.1/4"	1.1/4"	1.1/4"	1"	1/2"	1/2"	1/2"

TECHNICAL CHARACTERISTICS

MODEL	MAX WORKING PRESSURE CYLINDER (Secondary circuit)	MAXIMUM WORKING TEMPERATURE
SXC-100	3 bar	99 °C
SXC-200		
SXC-300		
SXC-500		
SXC-600		
SXC-800		
SXC-900		

MODEL	EXTERNAL INSULATION				INTERNAL INSULATION				(*) INSULATION THERMAL LOSS	EXTERNAL COVER
	INSULATION TYPE	INSULATION THICKNESS	INSULATION DENSITY	INITIAL THERMAL CONDUCTIVITY	INSULATION TYPE	INSULATION THICKNESS	INSULATION DENSITY	INITIAL THERMAL CONDUCTIVITY		
SXC-100	flexible polyurethane	50 mm	16 kg/m ³	44,2 mW/m K	Closed cells elastomer	20 mm	30 kg/m ³	39 mW/m K	0,648	PVC th. 5 mm RAL 9006
SXC-200									0,984	
SXC-300									1,344	
SXC-500									2,040	
SXC-600									2,424	
SXC-800									3,192	
SXC-900									3,288	

(*) Thermal loss calculated with an accumulation temperature equal to 65 °C and with an external temperature equal to 20 °C.

SAFETY DEVICES

The cylinders must be protected against the effects of over pressure by installing:

- A **SAFETY VALVE** calibrated to pressure below the max pressure of the accumulator
- A **SANITARY EXPANSION TANK** mod. ELBI **D - DV series**

MODEL	RECOMMENDED SANITARY EXPANSION TANK (mod. ELBI D-DV series)
SXC-100	D - 11
SXC-200	D - 18
SXC-300	DV - 24
SXC-500	DV - 50
SXC-600	DV - 50
SXC-800	DV - 80
SXC-900	DV - 80

Sized using the following parameters: T. accumulation= 85 °C / T. inlet = 15 °C / Pre-charge pressure = 3 bar / Max pressure = 6 bar
The recommended capacity must be verified on the basis of the actual dimensions of the system implemented.

SEE TABLE OF SYMBOLS
IN THE SHUTTER OF THE
COVER

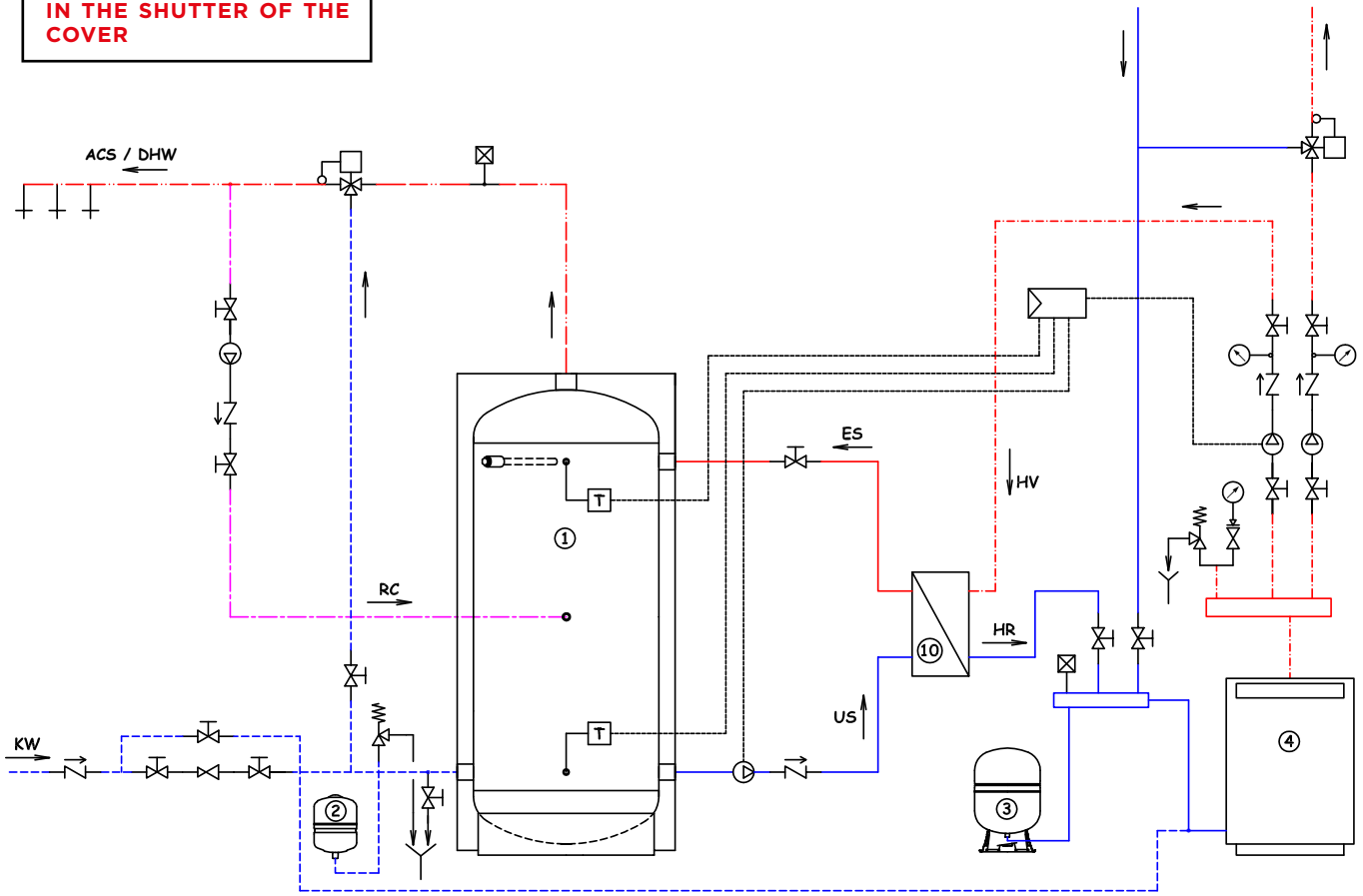



VR
THERMO-ACCUMULATOR

VS
INTERNAL CYLINDER



COMBI

MULTY ENERGY BUFFER TANKS

FOR STORAGE OF HOT WATER FOR HEATING & DHW PRODUCTION (500 - 1000 LITRES)

CMS 500 - 800 - 1000

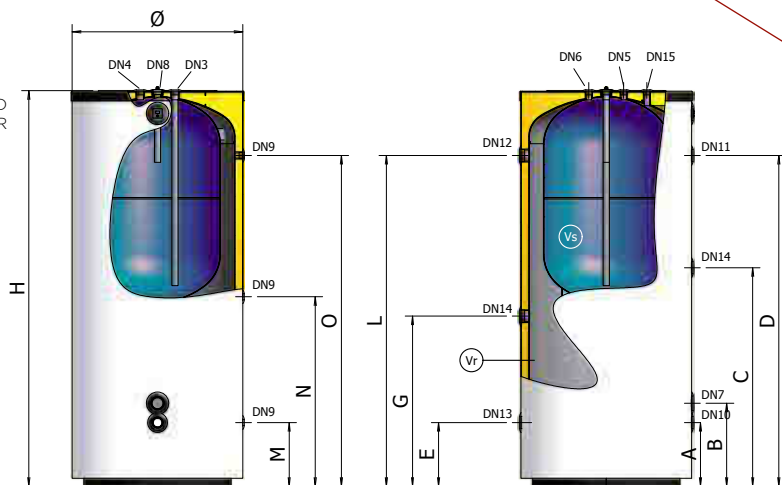
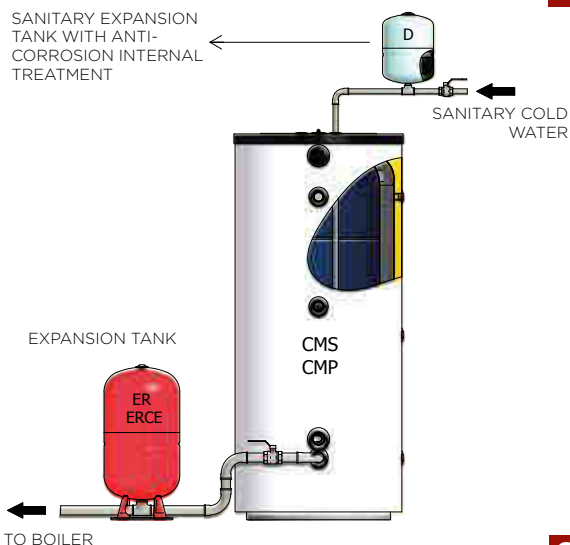

CMP 500 - 800 - 1000

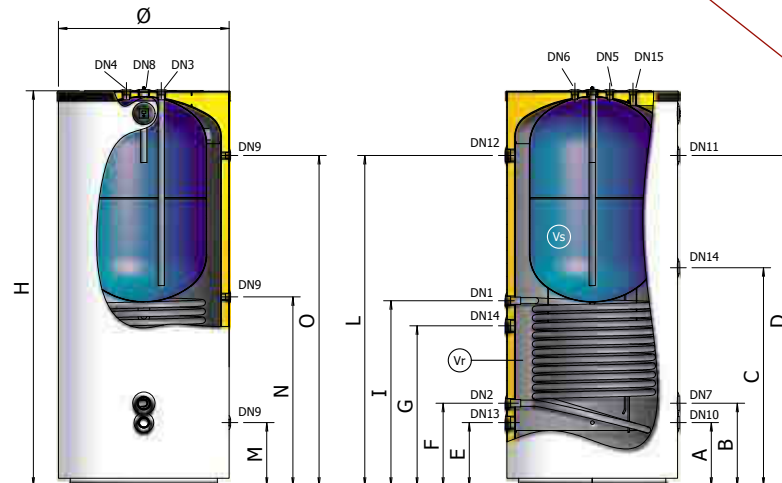

KEYWORD

DN1: Heat exchanger inlet; **DN2:** Heat exchanger outlet; **DN3:** Sanitary cold water inlet; **DN4:** Sanitary cold water outlet; **DN5:** Sanitary circuit probe; **DN6:** Sanitary hot water recirculation; **DN7:** Heating element; **DN8:** Magnesium anode; **DN9:** Heat system probes; **DN10:** System return; **DN11:** System delivery; **DN12:** Boiler delivery; **DN13:** Boiler return; **DN14:** Heating system recirculation; **DN15:** Drain

CYLINDER

FOR SANITARY HOT WATER

SUITABLE FOR SOLAR SYSTEMS

ANODE WITH TESTER

FOR HEATING SYSTEMS

POLYURETHANE INSULATION

TANK FOR HOT WATER STORAGE

+ 95°C
MAX WORKING TEMPERATURE OF THERMO-ACCUMULATOR

+ 95°C
MAX WORKING TEMPERATURE OF SANITARY ACCUMULATOR

+ 110°C
HEAT EXCHANGER MAX TEMPERATURE

$P_{max Vs}$ 6 bar
MAX WORKING PRESSURE OF SANITARY ACCUMULATOR

$P_{max Vr}$ 3 bar
MAX WORKING PRESSURE OF THERMO-ACCUMULATOR

P_{scA} 12 bar
MAX PRESSURE OF EXCHANGER

WARRANTY: 2 YEARS

REFERENCE STANDARDS

CYLINDER:

2014/68/EU Directive - ART. 4.3, without CE marking

Designed and built in accordance with the requirements of the 2009/125/EC.

Labeling in accordance with the requirements of the 2010/30/EU.

INTERNAL GLASSLINING OF SANITARY ACCUMULATOR Vs:

DIN 4753

The glasslining treatment makes the cylinder suitable to contain hot water for sanitary and hygienic use and resistant to corrosive phenomena.

INSULATION:

Hard, expanded polyurethane without CFC and HCFC.

HEAT EXCHANGER:

Single-tube fixed heat exchanger in carbon steel for alternative sources.

INSTALLATION:

- traditional boilers (wall-hung and/or floor-standing)
- condensing boilers
- solar thermal systems

DIMENSIONS

MODEL	CODE	ENERGY LABEL	LITRES	LITRES Vs	LITRES Vr	HEAT EXCHANGER		mm	mm	NOTES
						m ²	LITRES			
CMS-500	A3D0L55 0000S	D	500	100	400	/	/	750	1695	
CMS-800	A3D0L60 0000S	/	800	200	600	/	/	900	1795	
CMS-1000	A3D0L62 0000S	/	1000	300	700	/	/	900	2045	
CMP-500	A3D0L55 0000P	D	500	100	400	2,00	13	750	1695	
CMP-800	A3D0L60 0000P	/	800	200	600	2,50	15	900	1795	
CMP-1000	A3D0L62 0000P	/	1000	300	700	2,50	15	900	2045	

MODEL	A mm	B mm	C mm	D mm	E mm	F mm	G mm	I mm	L mm	M mm	N mm	O mm
CMS-500	280	390	1030	1430	/	280	780	/	1430	280	905	1430
CMS-800	330	430	980	1480	/	330	830	/	1480	330	880	1480
CMS-1000	330	430	1130	1710	/	330	880	/	1710	330	980	1710
CMP-500	280	390	1030	1430	390	280	780	970	1430	280	905	1430
CMP-800	330	440	1080	1480	430	330	780	930	1480	330	955	1480
CMP-1000	330	430	1130	1710	430	330	830	960	1710	330	980	1710

MODEL	ANODE ø x ø conn. x L	DN														
		1	2	3	4	5	6	7	8	9	10	11	12	13	14	15
CMS-500	32 x 1.1/4" x 350	/	/	3/4"	3/4"	1/2"	1/2"	2"	1.1/4"	1/2"	1.1/2"	1.1/2"	1.1/2"	1.1/2"	1.1/2"	1.1/2"
CMS-800	32 x 1.1/4" x 350	/	/	3/4"	3/4"	1/2"	1/2"	2"	1.1/4"	1/2"	1.1/2"	1.1/2"	1.1/2"	1.1/2"	1.1/2"	1.1/2"
CMS-1000	32 x 1.1/4" x 350	/	/	3/4"	3/4"	1/2"	1/2"	2"	1.1/4"	1/2"	1.1/2"	1.1/2"	1.1/2"	1.1/2"	1.1/2"	1.1/2"
CMP-500	32 x 1.1/4" x 350	1"	1"	3/4"	3/4"	1/2"	1/2"	2"	1.1/4"	1/2"	1.1/2"	1.1/2"	1.1/2"	1.1/2"	1.1/2"	1.1/2"
CMP-800	32 x 1.1/4" x 350	1"	1"	3/4"	3/4"	1/2"	1/2"	2"	1.1/4"	1/2"	1.1/2"	1.1/2"	1.1/2"	1.1/2"	1.1/2"	1.1/2"
CMP-1000	32 x 1.1/4" x 350	1"	1"	3/4"	3/4"	1/2"	1/2"	2"	1.1/4"	1/2"	1.1/2"	1.1/2"	1.1/2"	1.1/2"	1.1/2"	1.1/2"

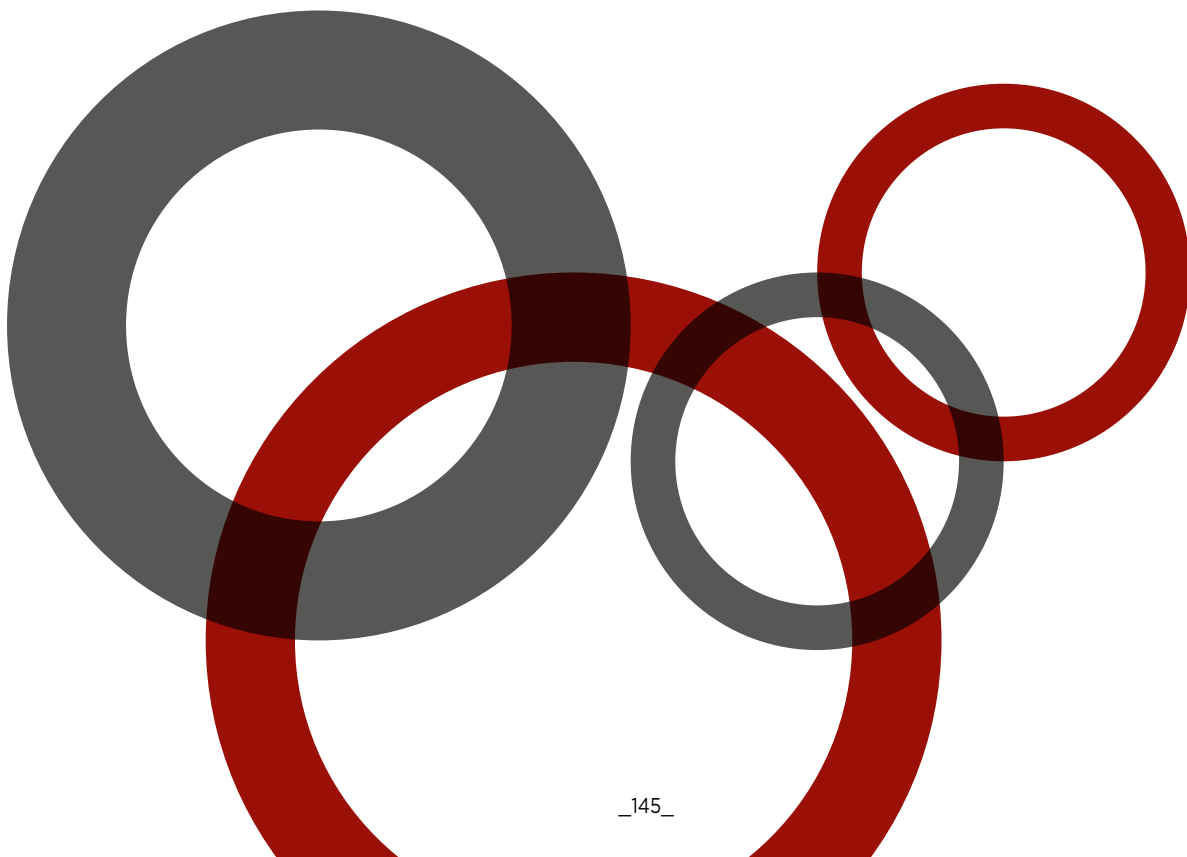

TECHNICAL CHARACTERISTICS

MODEL	MAX WORKING PRESSURE THERMO-ACCUMULATOR (Primary circuit)	MAX WORKING PRESSURE SANITARY TANK (Secondary circuit)	HEAT EXCHANGER	HEAT EXCHANGER PRESSURE DROP STAINLESS STEEL HEAT EXCHANGER
CMS-500	3 bar	6 bar	12 bar	/
CMS-800				/
CMS-1000				/
CMP-500				350 mbar
CMP-800				350 mbar
CMP-1000				400 mbar

MODEL	INSULATION TYPE	INSULATION THICKNESS	INSULATION DENSITY	INITIAL THERMAL CONDUCTIVITY	(*) INSULATION THERMAL LOSS	EXTERNAL COVER
COMBI 500	95% closed cells rigid expanded polyurethane, CFC - HCFC free	50 mm	40 kg/m ³	23,5 mW/m K	1,992 kWh / 24h	Grey polystyrene RAL 9006
COMBI 800					2,208 kWh / 24h	
COMBI 1000					3,192 kWh / 24h	

(*) Thermal loss calculated with an accumulation temperature equal to 65 °C and with an external temperature equal to 20 °C.

SAFETY DEVICES

ATTENTION:

DURING INSTALLATION, MAKE SURE THAT THE INTERNAL DHW CYLINDER (Vs) IS FILLED AND PRESSURIZED BEFORE THE THERMO-ACCUMULATOR (Vr).

IN ALL EVENTS, THE THERMO-ACCUMULATOR (Vr) PRESSURE MUST NEVER EXCEED THE INTERNAL DHW CYLINDER (Vs) PRESSURE OF 1.5 BAR.

The cylinders must be protected against the effects of over pressure by installing:

- **A SAFETY VALVE** calibrated to pressure below the max pressure of the cylinder
- **A SANITARY EXPANSION TANK** for the cylinder (VS) mod. ELBI **D - DV series**
- **AN EXPANSION TANK FOR THE THERMO-ACCUMULATOR (Vr) mod. ELBI ERCE series**

The ERCE series expansion tank must be adequately sized based on the total capacity of the system

MODEL	RECOMMENDED EXPANSION TANK FOR SANITARY CIRCUIT (mod. ELBI D-DV series)	RECOMMENDED EXPANSION TANK FOR BUFFER TANK (mod. ELBI ERCE series)
COMBI 500	D - 8	ERCE - 35
COMBI 800	D - 18	ERCE - 50
COMBI 1000	D - 24	ERCE - 80

Sized using the following parameters: T. accumulation= 85 °C / T. inlet = 15 °C / Pre-charge pressure = 3 bar / Max pressure = 6 bar
The recommended capacity must be verified on the basis of the actual dimensions of the system implemented.

ACCUMULATION AT 70 °C

DHW TANK: T.inlet =15°C; T.outlet= 45°C

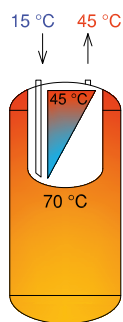

MODEL	THERMAL POWER [kW]	HEATING TIME ⁽¹⁾ [min]	PRODUCTION DHW AT 45°C [l/hour]
COMBI 500	13	16	370
COMBI 800	20	20	560
COMBI 1000	23	30	640

ACCUMULATION AT 70 °C

DHW TANK: T.inlet =15°C; T.outlet= 60°C

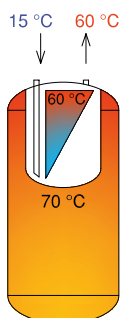

MODEL	THERMAL POWER [kW]	HEATING TIME ⁽¹⁾ [min]	PRODUCTION DHW AT 60°C [l/hour]
COMBI 500	9	35	170
COMBI 800	13	48	250
COMBI 1000	15	60	290

ACCUMULATION AT 80 °C

DHW TANK: T.inlet =15°C; T.outlet= 45°C

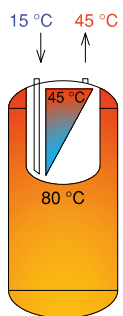

MODEL	THERMAL POWER [kW]	HEATING TIME ⁽¹⁾ [min]	PRODUCTION DHW AT 45°C [l/hour]
COMBI 500	17	12	490
COMBI 800	25	16	730
COMBI 1000	29	22	840

ACCUMULATION AT 80 °C

DHW TANK: T.inlet =15°C; T.outlet= 60°C.

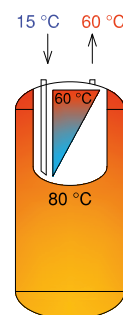

MODEL	THERMAL POWER [kW]	HEATING TIME ⁽¹⁾ [min]	PRODUCTION DHW AT 60°C [l/hour]
COMBI 500	13	23	250
COMBI 800	20	32	380
COMBI 1000	23	45	440

HYDRAULIC DIAGRAM FOR COMBI-PLUS AND STANDARD SANITARY CIRCUIT

SEE TABLE OF SYMBOLS
IN THE SHUTTER OF THE
COVER

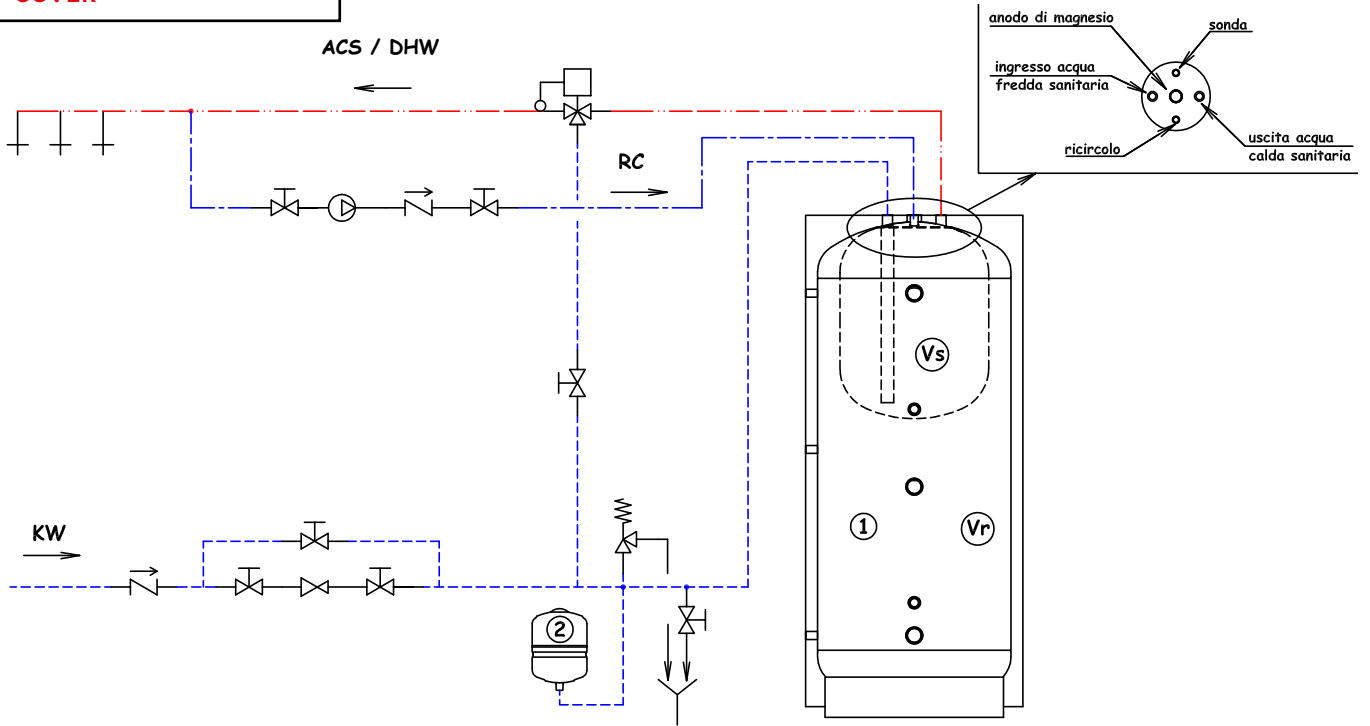

HYDRAULIC DIAGRAM OF COMBI-STANDARD HEATING CIRCUIT

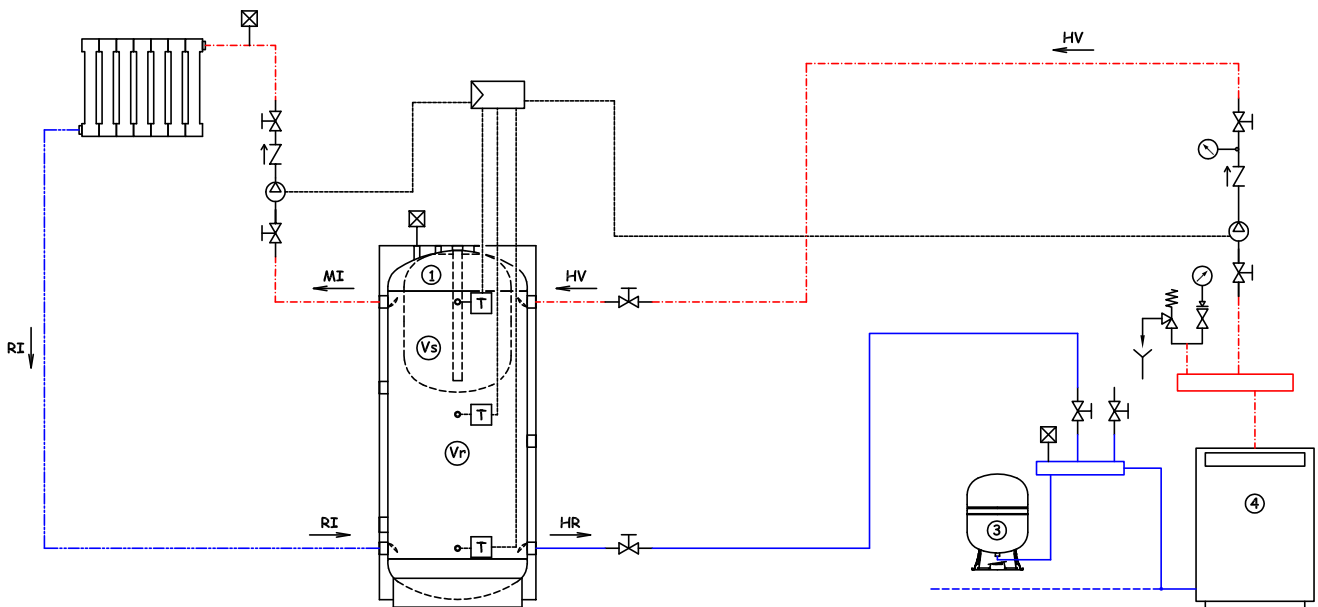

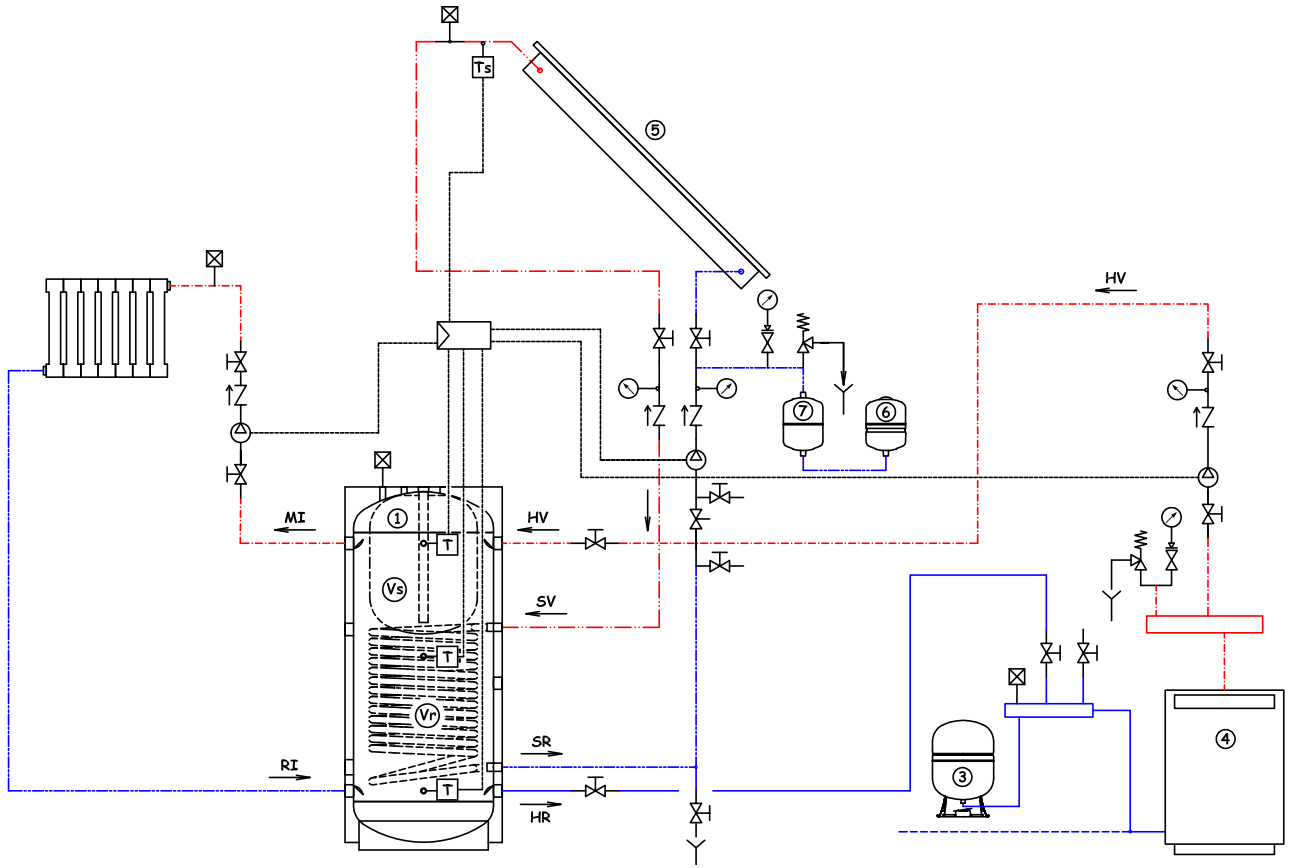



COMBI QUICK

MULTY ENERGY BUFFER TANKS

FOR STORAGE OF HOT WATER FOR HEATING & INSTANT DHW PRODUCTION (500 - 1000 LITRES)

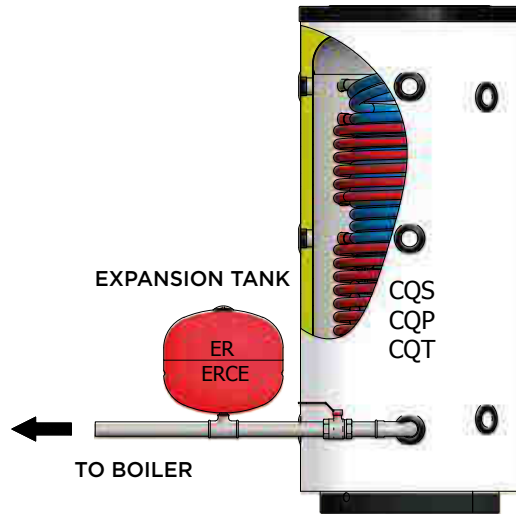

CQS 500 - 800 - 1000

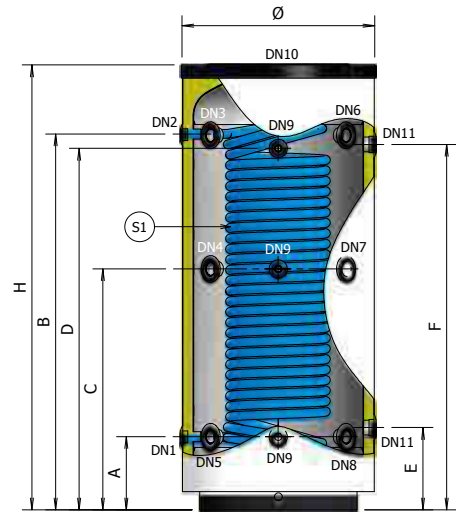

CQP 500 - 800 - 1000

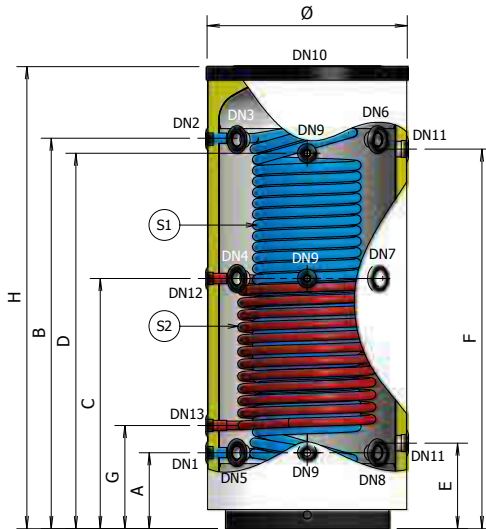

CQT 500 - 800 - 1000

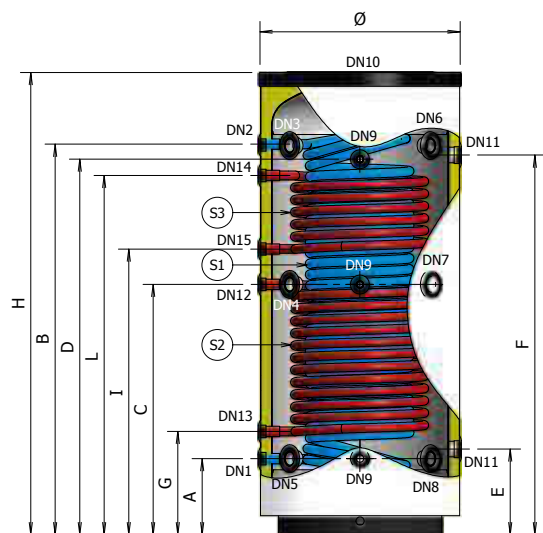

KEYWORD

DN1: Sanitary cold water inlet; **DN2:** Sanitary hot water outlet; **DN3:** From boiler; **DN4:** To floor heating system; **DN5:** To boiler; **DN6:** To heating system (plant); **DN7:** From heating system; **DN8:** From floor heating system; **DN9:** Probes; **DN10:** Air vent / to heating systems; **DN11:** Heating element; **DN12:** Lower heat exchanger inlet; **DN13:** Lower heat exchanger outlet; **DN14:** Upper heat exchanger inlet; **DN15:** Upper heat exchanger outlet;



CYLINDER



FOR SANITARY HOT WATER



SUITABLE FOR SOLAR SYSTEMS



POLYURETHANE INSULATION



THERM-ACCUMULATOR FOR INSTANT SANITARY HOT WATER



HOT WATER STORAGE TANK



STAINLESS STEEL HEAT EXCHANGER



FOR HEATING SYSTEMS



+ 95°C
MAX TEMPERATURE
OF CYLINDER



+ 110°C
HEAT EXCHANGER MAX
TEMPERATURE



P_{MAX} 10 bar
MAX WORKING PRESSURE
OF THERMO-ACCUMULATOR



P_{SCA} 12 bar
HEAT EXCHANGER
MAX PRESSURE

WARRANTY: 2 YEARS

REFERENCE STANDARDS

CYLINDER:

2014/68/UE Directive - ART. 4.3, without CE marking
Designed and built in accordance with the requirements of the 2009/125/EC.
Labeling in accordance with the requirements of the 2010/30/EU.

INSULATION:

Hard expanded polyurethane without CFC and HCFC.

HEAT EXCHANGER:

Single-tube fixed heat exchanger in stainless steel for sanitary hot water.

On request, additional heat exchangers for alternative sources are available.

INSTALLATION:

- traditional boilers (wall-hung and/or floor-standing)
- condensing boilers
- solar thermal systems

MODEL	CODE	ENERGY LABEL	CL	LITRES	HEAT EXCHANGER						mm	mm	NOTES
					STAINLESS STEEL S1		LOWER S2		UPPER S3				
				m ²	LITRES	m ²	LITRES	m ²	LITRES				
CQS-500	A3W0L55 PGP40	D	500	3,50	25	/	/	/	/	750	1695		
CQS-800	A3W0L60 PGP40	/	800	3,80	28	/	/	/	/	900	1795		
CQS-1000	A3W0L62 PGP40	/	1000	4,50	33	/	/	/	/	900	2045		
CQP-500	A3W1L55 PGP40	D	500	3,50	25	1,80	12	/	/	750	1695		
CQP 800	A3W1L60 PGP40	/	800	3,80	28	2,00	13	/	/	900	1795		
CQP-1000	A3W1L62 PGP40	/	1000	4,50	33	2,40	15	/	/	900	2045		
CQT-500	A3W2L55 PGP40	D	500	3,50	25	1,80	12	0,90	6	750	1695		
CQT-800	A3W2L60 PGP40	/	800	3,80	28	2,00	13	1,20	8	900	1795		
CQT-1000	A3W2L62 PGP40	/	1000	4,50	33	2,40	15	1,20	8	900	2045		

MODEL	A mm	B mm	C mm	D mm	E mm	F mm	G mm	I mm	L mm
CQS-500	280	1430	920	1380	315	1395	/	/	/
CQS-800	330	1480	905	1470	365	1445	/	/	/
CQS-1000	365	1720	1125	1720	410	1680	/	/	/
CQP-500	280	1430	920	1380	315	1395	380	/	/
CQP 800	330	1480	905	1470	365	1445	445	/	/
CQP-1000	365	1720	1125	1720	410	1680	530	/	/
CQT-500	280	1430	920	1380	315	1395	380	1050	1320
CQT-800	330	1480	905	1470	365	1445	445	1060	1330
CQT-1000	365	1720	1125	1720	410	1680	530	1290	1560

MODEL	DN 1	DN 2	DN 3	DN 4	DN 5	DN 6	DN 7	DN 8	DN 9	DN 10	DN 11	DN 12	DN 13	DN 14	DN 15
CQS-500	1"	1"	1.1/2"	1.1/2"	1.1/2"	1.1/2"	1.1/2"	1.1/2"	1/2"	1.1/4"	1.1/2"	/	/	/	/
CQS-800	1"	1"	1.1/2"	1.1/2"	1.1/2"	1.1/2"	1.1/2"	1.1/2"	1/2"	1.1/4"	1.1/2"	/	/	/	/
CQS-1000	1"	1"	1.1/2"	1.1/2"	1.1/2"	1.1/2"	1.1/2"	1.1/2"	1/2"	1.1/4"	1.1/2"	/	/	/	/
CQP-500	1"	1"	1.1/2"	1.1/2"	1.1/2"	1.1/2"	1.1/2"	1.1/2"	1/2"	1.1/4"	1.1/2"	1"	1"	/	/
CQP 800	1"	1"	1.1/2"	1.1/2"	1.1/2"	1.1/2"	1.1/2"	1.1/2"	1/2"	1.1/4"	1.1/2"	1"	1"	/	/
CQP-1000	1"	1"	1.1/2"	1.1/2"	1.1/2"	1.1/2"	1.1/2"	1.1/2"	1/2"	1.1/4"	1.1/2"	1"	1"	/	/
CQT-500	1"	1"	1.1/2"	1.1/2"	1.1/2"	1.1/2"	1.1/2"	1.1/2"	1/2"	1.1/4"	1.1/2"	1"	1"	1"	1"
CQT-800	1"	1"	1.1/2"	1.1/2"	1.1/2"	1.1/2"	1.1/2"	1.1/2"	1/2"	1.1/4"	1.1/2"	1"	1"	1"	1"
CQT-1000	1"	1"	1.1/2"	1.1/2"	1.1/2"	1.1/2"	1.1/2"	1.1/2"	1/2"	1.1/4"	1.1/2"	1"	1"	1"	1"

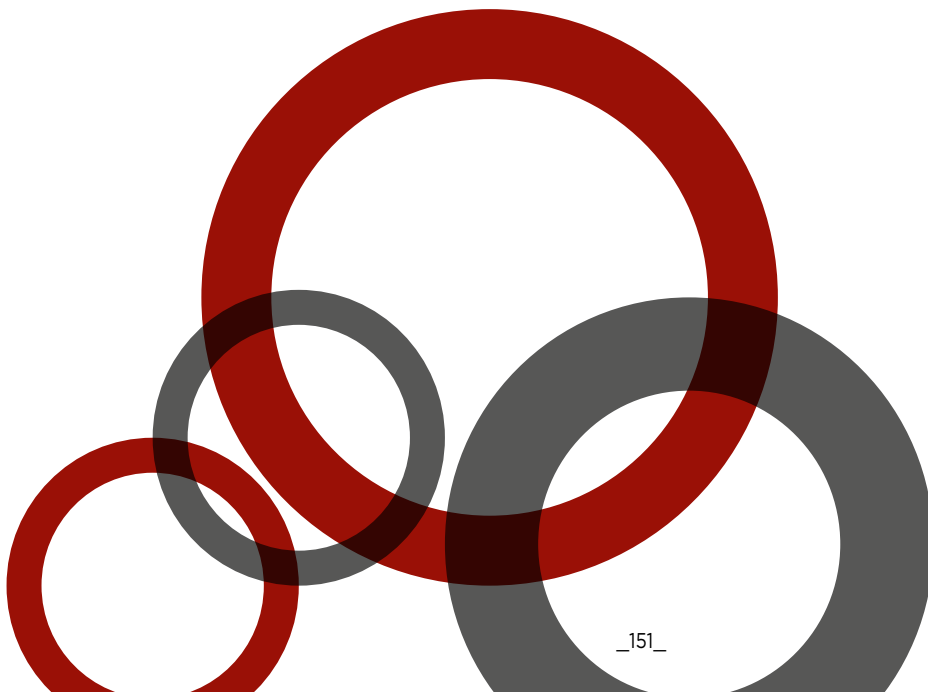

TECHNICAL CHARACTERISTICS

MODEL	MAX WORKING PRESSURE STORAGE TANK CASING (Secondary circuit)	MAX WORKING PRESSURE EXCHANGER (Circuits of alternative sources and DHW production)	HEAT EXCHANGER PRESSURE DROP		
			LOWER HEAT EXCHANGER	UPPER HEAT EXCHANGER	STAINLESS STEEL HEAT EXCHANGER
CQS-500	10 bar	12 bar	/	/	40 mbar
CQS-800			/	/	45 mbar
CQS-1000			/	/	50 mbar
CQP-500			300 mbar	/	40 mbar
CQP-800			350 mbar	/	45 mbar
CQP-1000			400 mbar	/	50 mbar
CQT-500			300 mbar	120 mbar	40 mbar
CQT-800			350 mbar	200 mbar	45 mbar
CQT-1000			400 mbar	200 mbar	50 mbar

MODEL	INSULATION TYPE	INSULATION THICKNESS	INSULATION DENSITY	INITIAL THERMAL CONDUCTIVITY	(*) INSULATION THERMAL LOSS	EXTERNAL COVER
COMBI QUICK 500	95% closed cells rigid expanded polyurethane, CFC - HCFC free	50 mm	40 kg/m ³	23,5 mW/m K	3,192 kWh / 24h	Grey polystyrene RAL 9006
COMBI QUICK 800					3,958 kWh / 24h	
COMBI QUICK 1000					4,449 kWh / 24h	

(*) Thermal loss calculated with an accumulation temperature equal to 65 °C and with an external temperature equal to 20 °C.

SAFETY DEVICES

The cylinders must be protected against the effects of over pressure by installing:

- A **SAFETY VALVE** calibrated to pressure below the max pressure of the cylinder
- A **SANITARY EXPANSION TANK** mod. ELBI D - DV series
- AN **EXPANSION TANK FOR THE THERMO-ACCUMULATOR (Vr) mod. ELBI ERCE series**

The ERCE series expansion tank must be adequately sized based on the total capacity of the system

MODEL	RECOMMENDED EXPANSION TANK IN SANITARY CIRCUIT (mod. ELBI D-DV series)	RECOMMENDED EXPANSION TANK (mod. ELBI ERCE series)
COMBI QUICK 500	D - 5	ERCE - 35
COMBI QUICK 800	D - 8	ERCE - 50
COMBI QUICK 1000	D - 11	ERCE - 80

Sized using the following parameters: T. accumulation= 85 °C / T. inlet = 15 °C / Pre-charge pressure = 3 bar / Max pressure = 6 bar
The recommended capacity must be verified on the basis of the actual dimensions of the system implemented.

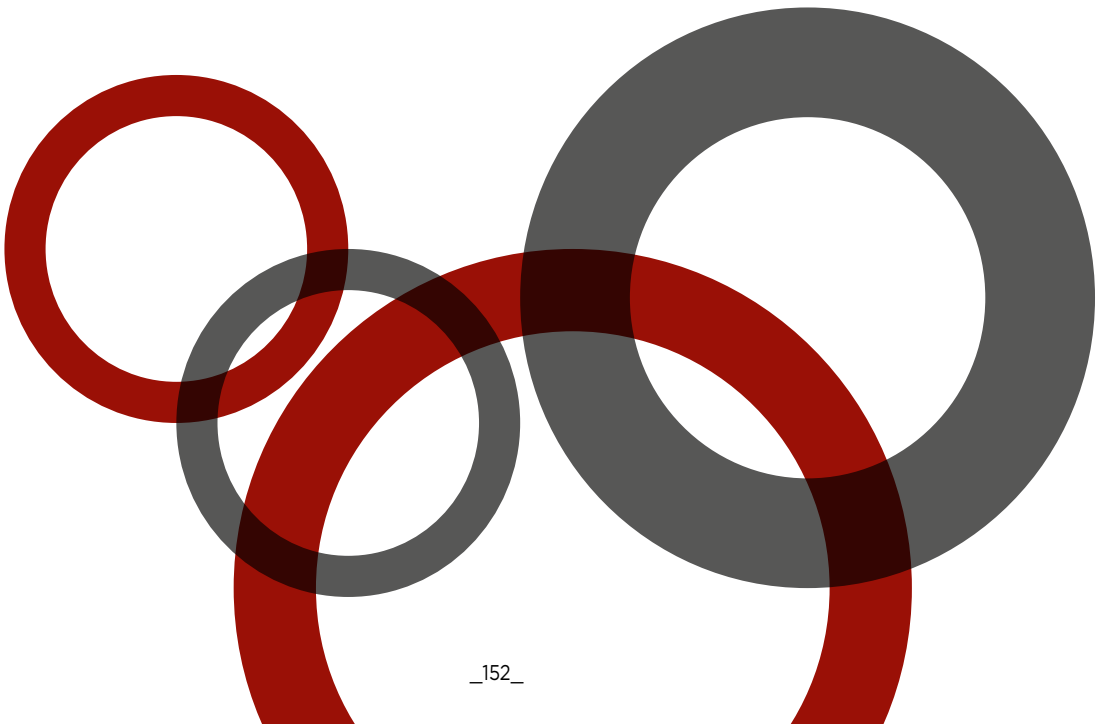

ACCUMULATION AT 60 °C

STAINLESS STEEL HEAT EXCHANGER: T.inlet =15°C; T.outlet= 45°C

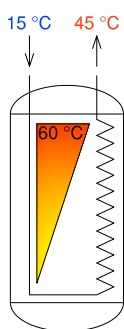

MODEL	THERMAL POWER [kW]	PRODUCTION DHW AT 45°C [lt/h]
COMBI QUICK 500	24	710
COMBI QUICK 800	26	760
COMBI QUICK 1000	30	860

Continuous production of hot water at 45 °C with accumulation at 60 °C

ACCUMULATION AT 70 °C

STAINLESS STEEL HEAT EXCHANGER: T.inlet =15°C; T.outlet= 45°C

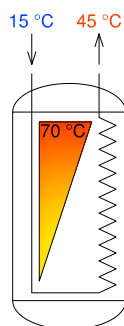

MODEL	THERMAL POWER [kW]	PRODUCTION DHW AT 45°C [lt/h]
COMBI QUICK 500	33	960
COMBI QUICK 800	35	1000
COMBI QUICK 1000	42	1220

Continuous production of hot water at 45 °C with accumulation at 70 °C

ACCUMULATION AT 80 °C

STAINLESS STEEL HEAT EXCHANGER: T.inlet =15°C; T.outlet= 45°C

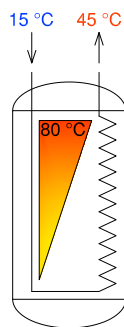

MODEL	THERMAL POWER STAINLESS STEEL HEAT EXCHANGER [kW]	PRODUCTION DHW AT 45°C [lt/h]
COMBI QUICK 500	42	1210
COMBI QUICK 800	45	1300
COMBI QUICK 1000	54	1570

Continuous production of hot water at 45 °C with accumulation at 80 °C

SEE TABLE OF SYMBOLS
IN THE SHUTTER OF THE
COVER

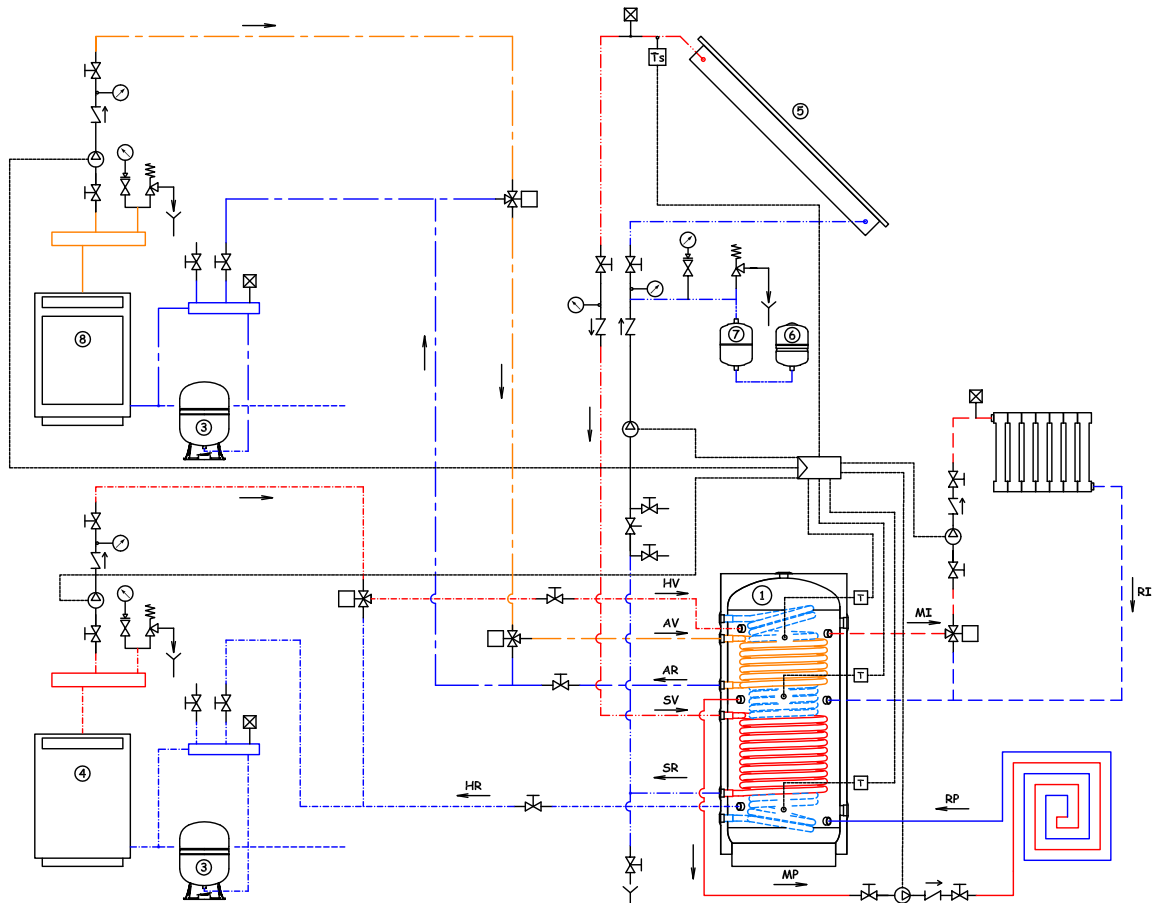
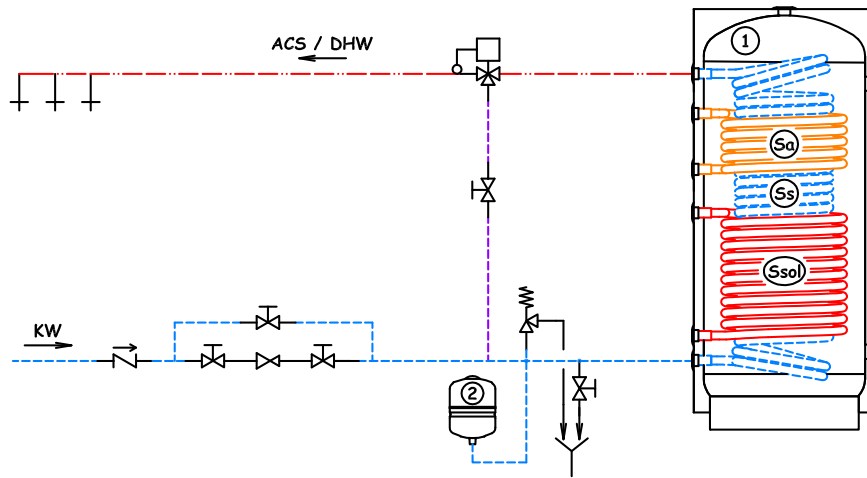





BF1

GLASSLINED CYLINDERS

WITH REMOVABLE STAINLESS STEEL HEAT EXCHANGER (1.500 - 5.000 LITRES)

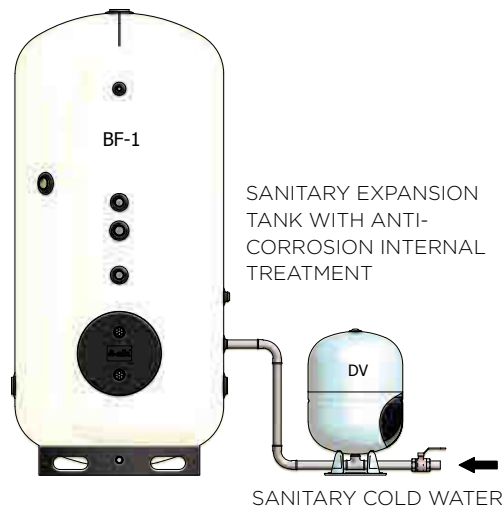

BF1 1500 - 2000 - 3000 - 5000

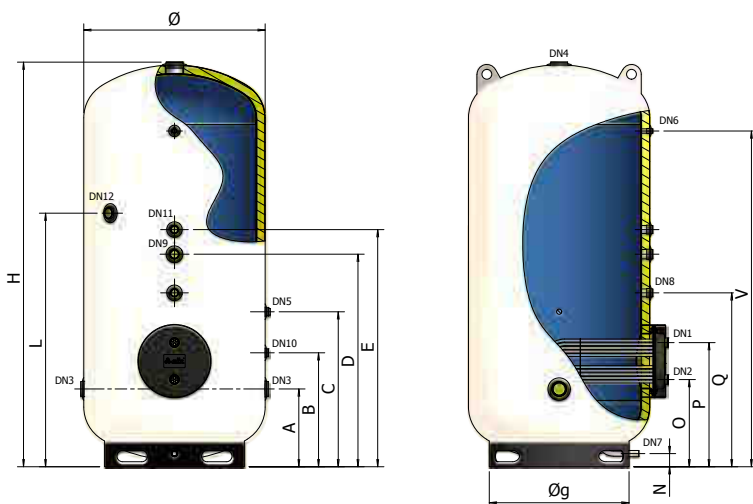

KEYWORD

DN1: Primary fluid inlet (heat exchanger side); **DN2:** Primary fluid outlet (heating side); **DN3:** Sanitary cold water inlet; **DN4:** Sanitary hot water outlet; **DN5:** Magnesium anode; **DN6:** Probes (Thermometer, Thermostat); **DN7:** Tank drain; **DN8:** Thermo-regulation; **DN9:** Recirculation; **DN10:** Sanitary expansion tank; **DN11:** Extra optional Magnesium Anode; **DN12:** Extra optional heating element;

CYLINDER	+ 95°C WORKING TEMPERATURE
FOR SANITARY HOT WATER	
SUITABLE FOR SOLAR SYSTEMS	+110°C HEAT EXCHANGER MAX TEMPERATURE
INTERNAL, GLASSLINING ANTI-CORROSION TREATMENT	
POLYURETHANE INSULATION	P_{MAX} 6 bar MAX WORKING PRESSURE
HEAT EXCHANGER IN STAINLESS STEEL AISI 304	P_{SCA} 12 bar HEAT EXCHANGER MAX PRESSURE
HANDLING BY FORKLIFT	WARRANTY: 5 YEARS

REFERENCE STANDARDS CYLINDER:

2014/68/UE Directive - ART. 4.3, without CE marking
Ecodesign 2009/125/EC

INTERNAL GLASSLINING:

DIN 4753
The glasslining treatment makes the cylinder suitable to contain hot water for sanitary and hygienic use and resistant to corrosive phenomena.

INSULATION:

Expanded, flexible polyurethane with open cells.

HEAT EXCHANGER:

Removable U pipe stainless steel heat exchanger.

INSTALLATION:

- traditional boilers (wall-hung and/or floor-standing)
- condensing boilers
- solar thermal systems

MODEL	CODE	LOWER HEAT EXCHANGER					NOTES
		LITRES	m ²	LITRES	mm	mm	
BF-1 / 1500	A340H67 VW050	1500	3,00	15	1100	2465	
BF-1 / 2000	A340H70 VW050	2000	4,00	18	1200	2445	
BF-1 / 3000	A340H74 VW050	3000	6,00	24	1350	2840	
BF-1 / 5000	A340H80 VW050	5000	10,00	39	1700	2990	

MODEL	ANODE ø x ø conn. x L	DN	DN	DN	DN	DN	DN	DN	DN	DN	DN	DN	DN
		1	2	3	4	5	6	7	8	9	10	11	12
BF-1 / 1500	32 x 1.1/4" x 670	1.1/2"	1.1/2"	2.1/2"	3"	1.1/4"	1/2"	1"	1.1/4"	1.1/2"	1.1/4"	1.1/4"	2"
BF-1 / 2000	32 x 1.1/4" x 670	1.1/2"	1.1/2"	2.1/2"	3"	1.1/4"	1/2"	1"	1.1/4"	1.1/2"	1.1/4"	1.1/4"	2"
BF-1 / 3000	32 x 1.1/4" x 700	1.1/2"	1.1/2"	3"	3"	1.1/4"	1/2"	1"	1.1/4"	1.1/2"	1.1/4"	1.1/4"	2"
BF-1 / 5000	40 x 1.1/2" x 640	1.1/2"	1.1/2"	3"	3"	1.1/2"	1/2"	1"	1.1/4"	1.1/2"	1.1/4"	1.1/2"	2"

MODEL	A	B	C	D	E	F	G	I	L	M	N	O	P	Q	R	S	T	U	V
	mm	mm	mm	mm	mm	mm	mm	mm	mm	mm	mm	mm	mm	mm	mm	mm	mm	mm	mm
BF-1 / 1500	475	695	945	1295	1445	-	-	-	1545	-	80	530	755	1060	-	-	-	-	2045
BF-1 / 2000	465	685	935	1285	1435	-	-	-	1535	-	80	520	745	1050	-	-	-	-	2035
BF-1 / 3000	530	730	980	1480	1630	-	-	-	1730	-	80	565	790	1095	-	-	-	-	2380
BF-1 / 5000	635	835	1085	1585	1735	-	-	-	1835	-	80	670	895	1200	-	-	-	-	2485

TECHNICAL CHARACTERISTICS

HEAT EXCHANGER	CODE	MAXIMUM WORKING PRESSURE / MAXIMUM WORKING TEMPERATURE			PRESSURE DROP OF HEAT EXCHANGERS
		HOT WATER 12 BAR / 110 °C	SATURATED STEAM 1 BAR / 120 °C	SATURATED STEAM 2 BAR / 134 °C	
3,0 m ²	2950300 V0010	•	•	•	200 mBar
4,0 m ²	2950400 V0010	•	•	•	220 mBar
6,0 m ²	2960600 V0010	•	•	•	350 mBar
10,0 m ²	2961000 V0010	•	•	n.a.	400 mBar

N.B. If using the heat exchanger with temperatures over 100 °C, ask for steam seals

MODEL	INSULATION TYPE	INSULATION THICKNESS	INSULATION DENSITY	INITIAL THERMAL CONDUCTIVITY	(*) INSULATION THERMAL LOSS	EXTERNAL FINISH
BF-1 / 1500	Flexible expanded polyurethane with open cells	50 mm	15 kg/m ³	39,0 mW/m K	9,969 kWh / 24h	Skay white RAL 9001
BF-1 / 2000					10,865 kWh / 24h	
BF-1 / 3000					13,799 kWh / 24h	
BF-1 / 5000					18,264 kWh / 24h	

(*) Thermal loss calculated with an accumulation temperature equal to 65 °C and with an external temperature equal to 20 °C.

SAFETY DEVICES

The cylinders must be protected against the effects of over pressure by installing:

- A **SAFETY VALVE** calibrated to pressure below the max pressure of the cylinder
- A **SANITARY EXPANSION TANK** mod. ELBI **D - DV series**

MODEL	RECOMMENDED SANITARY EXPANSION TANK (mod. ELBI D-DV series)
BF-1 / 1500	DV - 150
BF-1 / 2000	DV - 150
BF-1 / 3000	DV - 300
BF-1 / 5000	n°2 pcs DV - 200

Sized using the following parameters: T. accumulation= 85 °C / T. inlet = 15 °C / Pre-charge pressure = 3 bar / Max pressure = 6 bar
The recommended capacity must be verified on the basis of the actual dimensions of the system implemented.

MODEL	MAGNESIUM ANODE SUPPLIED	CATHODIC PROTECTION APPLICABLE
BF-1 / 1500	1,1/4" x 670 / Cod.8560070	Cathodic protection for cylinders 1500/2000 l. Code 8560180
BF-1 / 2000	1,1/4" x 670 / Cod.8560070	
BF-1 / 3000	1,1/4" x 700 / Cod.8560080	Cathodic protection for cylinders 3000/5000 l. Code 8560185
BF-1 / 5000	1,1/2" x 640 / Cod.8560100	

ACCUMULATION AT 60 °C

HEAT EXCHANGER: T.inlet = 80°C; ΔT = 10°C.

STORAGE WATER HEATER: T.inlet =15°C; T. accumulation = 60°C

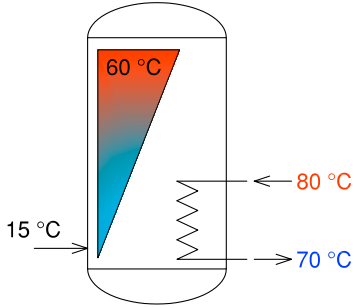

OPERATION WITH HOT WATER

MODEL	HEAT EXCHANGER [m ²]	THERMAL POWER [kW]	PUMP CAPACITY [l/hour]	HEATING TIME ⁽¹⁾ [min]	PRODUCTION DHW AT 60°C [l/hour]	QUANTITY DHW AT 45°C IN FIRST 10 min. ⁽²⁾ [l]
BF-1 / 1500	3,0	72,00	6400	70	1375	1243
BF-1 / 2000	4,0	98,00	8500	63	1828	1594
BF-1 / 3000	6,0	159,30	14100	58	3044	2524
BF-1 / 5000	10,0	250,70	22000	62	4790	4085

(1) Time required to bring the temperature of the cylinder from 15 °C to 60 °C.

(2) Quantity of DHW (Sanitary Hot Water) at 45°C available in the first 10 minutes with DHW accumulation at 60° C.

ACCUMULATION AT 45 °C

HEAT EXCHANGER: T.inlet = 80°C; ΔT = 10°C.

STORAGE WATER HEATER: T.inlet =15°C; T. accumulation = 45°C

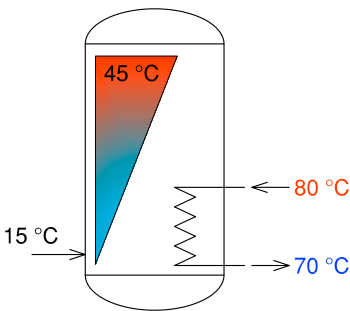

OPERATION WITH HOT WATER

MODEL	HEAT EXCHANGER [m ²]	THERMAL POWER [kW]	PUMP CAPACITY [l/hour]	HEATING TIME ⁽¹⁾ [min]	PRODUCTION DHW AT 45°C [l/hour]
BF-1 / 1500	3,0	92,00	8100	37	2635
BF-1 / 2000	4,0	131,60	11600	31	3770
BF-1 / 3000	6,0	223,60	19710	28	6410
BF-1 / 5000	10,0	339,00	29900	31	9720

1) Time required to bring the temperature of the cylinder from 15 °C to 45 °C.

ACCUMULATION AT 60 °C

HEAT EXCHANGER: T.inlet = 120°C (1 bar)

STORAGE WATER HEATER: T.inlet =15°C; T. accumulation = 60°C

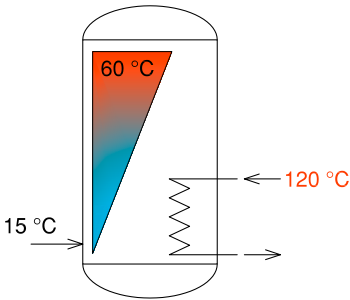

OPERATION WITH STEAM

MODEL	HEAT EXCHANGER [m ²]	THERMAL POWER [kW]	PUMP CAPACITY [l/hour]	HEATING TIME ⁽¹⁾ [min]	PRODUCTION DHW AT 60°C [l/hour]	QUANTITY DHW AT 45°C IN FIRST 10 min.
BF-1 / 1500	3,0	236,00	400	21	4600	2070
BF-1 / 2000	4,0	287,00	486	22	5575	2470
BF-1 / 3000	6,0	440,30	754	21	8400	3820
BF-1 / 5000	10,0	675,70	1143	23	12890	6020

(1) Time required to bring the temperature of the cylinder from 15 °C to 60 °C.

(2) Quantity of DHW (Sanitary Hot Water) at 45°C available in the first 10 minutes with DHW accumulation at 60° C.

ACCUMULATION AT 45 °C

HEAT EXCHANGER: T.inlet = 120°C (1 Bar)

STORAGE WATER HEATER: T.inlet =15°C; T. accumulation = 45°C

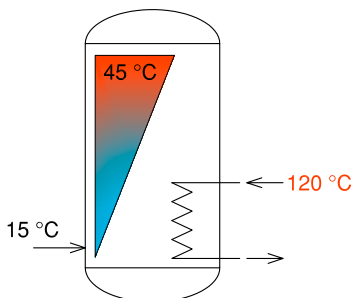

OPERATION WITH STEAM

MODEL	HEAT EXCHANGER [m ²]	THERMAL POWER [kW]	PUMP CAPACITY [l/hour]	HEATING TIME ⁽¹⁾ [min]	PRODUCTION DHW AT 60°C [l/hour]
BF-1 / 1500	3,0	265,60	450	13	7615
BF-1 / 2000	4,0	315,70	534	14	9048
BF-1 / 3000	6,0	495,00	839	13	14185
BF-1 / 5000	10,0	745,00	1263	14	21350

(1) Time required to bring the temperature of the cylinder from 15 °C to 45 °C.

ACCUMULATION AT 60 °C

HEAT EXCHANGER: T.inlet = 134°C (2 bar)

STORAGE WATER HEATER: T.inlet = 15°C; T. accumulation = 60°C

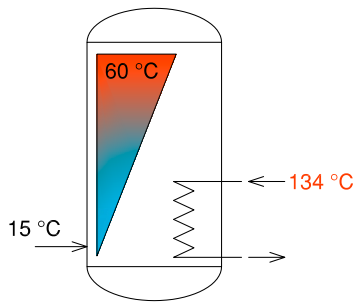

OPERATION WITH STEAM

MODEL	HEAT EXCHANGER [m ²]	THERMAL POWER [kW]	PUMP CAPACITY [l/hour]	HEATING TIME ⁽¹⁾ [min]	PRODUCTION DHW AT 60°C [l/hour]	Quantity DHW AT 45°C in first 10 min ⁽²⁾ [l]
BF-1 / 1500	3,0	278,00	479	19	5310	5310
BF-1 / 2000	4,0	338,00	583	18	6458	6458
BF-1 / 3000	6,0	525,00	905	18	10030	10030
BF-1 / 5000	10,0	790,00	1362	20	15095	15095

(1) Time required to bring the temperature of the cylinder from 15 °C to 60 °C.

(2) Quantity of DHW (Sanitary Hot Water) at 45°C available in the first 10 minutes with DHW accumulation at 60° C.

ACCUMULATION AT 45 °C

HEAT EXCHANGER: T.inlet = 134°C (2 bar)

STORAGE WATER HEATER: T.inlet = 15°C; T. accumulation = 45°C

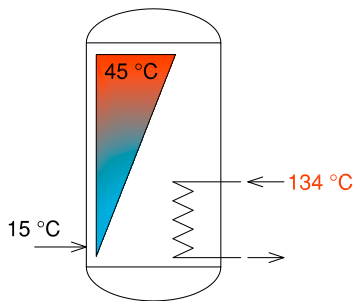

OPERATION WITH STEAM

MODEL	HEAT EXCHANGER [m ²]	THERMAL POWER [kW]	PUMP CAPACITY [l/hour]	HEATING TIME ⁽¹⁾ [min]	PRODUCTION DHW AT 45°C [l/hour]
BF-1 / 1500	3,0	306,30	528	11	8780
BF-1 / 2000	4,0	369,20	636	11	10580
BF-1 / 3000	6,0	645,00	1112	10	18485
BF-1 / 5000	10,0	820,00	1415	13	23500

(1) Time required to bring the temperature of the cylinder from 15 °C to 45 °C.

TABLE OF HEATING ELEMENT APPLICABILITY TO CYLINDERS

Heating element model*					Water heating time from 15° C to 60 °C (expressed in minutes) <i>The heating times outlined are approximate</i>			
CODE	Power (kW)	Voltage (Volt)	Connection	Length (mm)	BF-1 1500	BF-1 2000	BF-1 3000	BF-1 5000
8601000	1	220 V / MF	G 1.1/4"	295	4720 min.	6300 min.	9420 min.	15750 min.
8601650	1.65	220 V / MF	G 1.1/4"	450	2870 min.	3820 min.	5740 min.	9550 min.
8602000	2	220 V / MF	G 1.1/4"	515	2370 min.	3150 min.	4740 min.	7875 min.
8602600	2.6	220 V / MF	G 1.1/4"	675	1830 min.	2450 min.	3660 min.	6125 min.
8602601	2.6	220 V / MF	G 1.1/4"	360	1830 min.	2450 min.	3660 min.	6125 min.
8603300	3.3	220 V / MF	G 1.1/4"	825	1450 min.	1940 min.	2900 min.	4850 min.
8603301	3.3	220 V / MF	G 1.1/4"	435	1450 min.	1940 min.	2900 min.	4850 min.
8604001	4	220 V / MF	G 1.1/4"	510	1200 min.	1600 min.	2400 min.	4000 min.
8705000	5	380 V / TF	G 1.1/2"	445	950 min.	1300 min.	1900 min.	3250 min.
8706000	6	380 V / TF	G 1.1/2"	510	800 min.	1060 min.	1600 min.	2650 min.
8708000	8	380 V / TF	G 1.1/2"	670	610 min.	800 min.	1220 min.	2000 min.
8710000	10	380 V / TF	G 1.1/2"	820	490 min.	640 min.	980 min.	1600 min.
8712000	12	380 V / TF	G 1.1/2"	970	410 min.	540 min.	820 min.	1350 min.

n.a. =Heating element not applicable

SEE TABLE OF SYMBOLS
IN THE SHUTTER OF THE
COVER

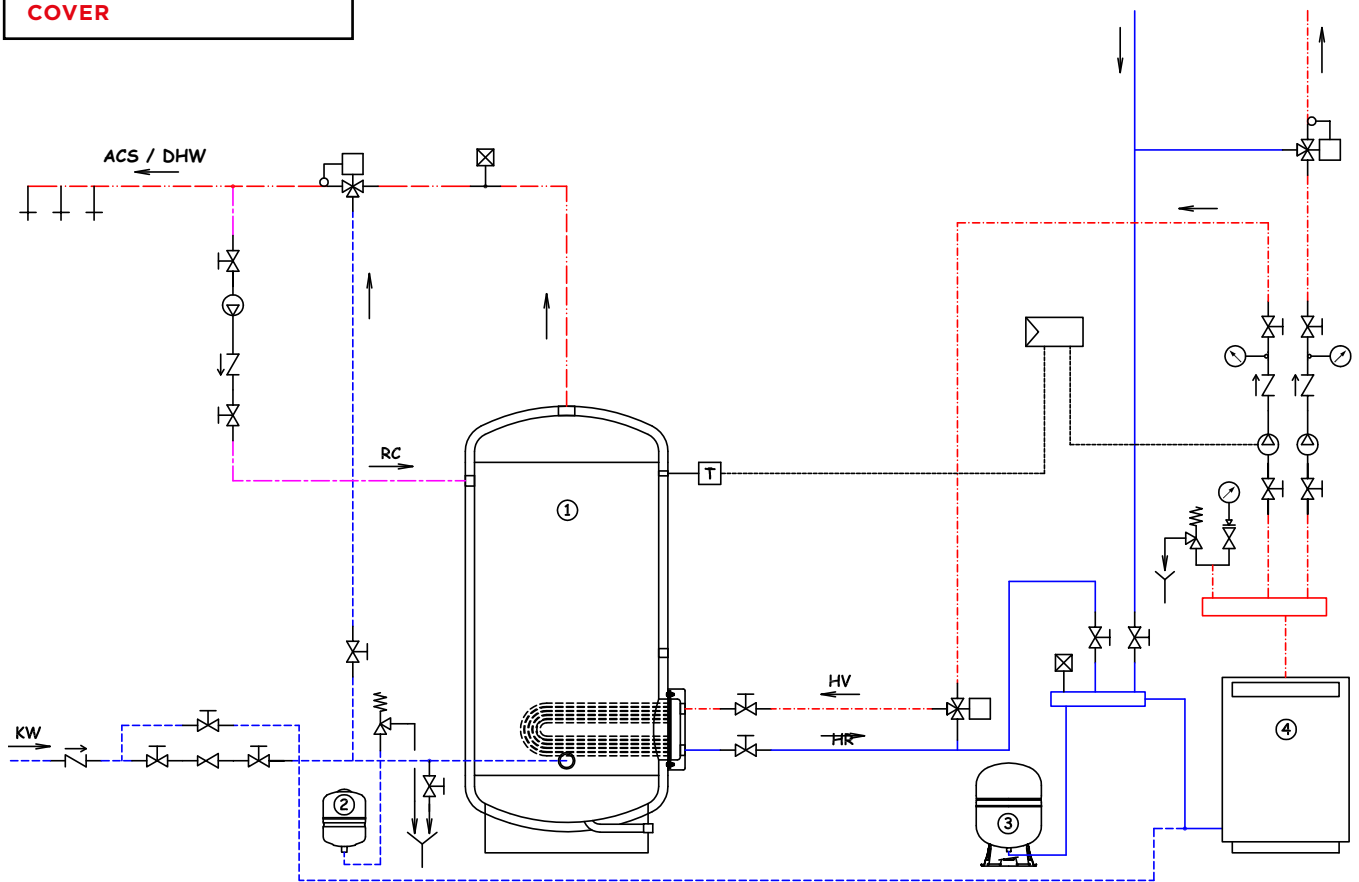



BF2

GLASSLINED CYLINDERS

WITH TWO REMOVABLE STAINLESS STEEL HEAT EXCHANGERS (1.500 - 5.000 LITRES)



BF2 1500 - 2000 - 3000 - 5000

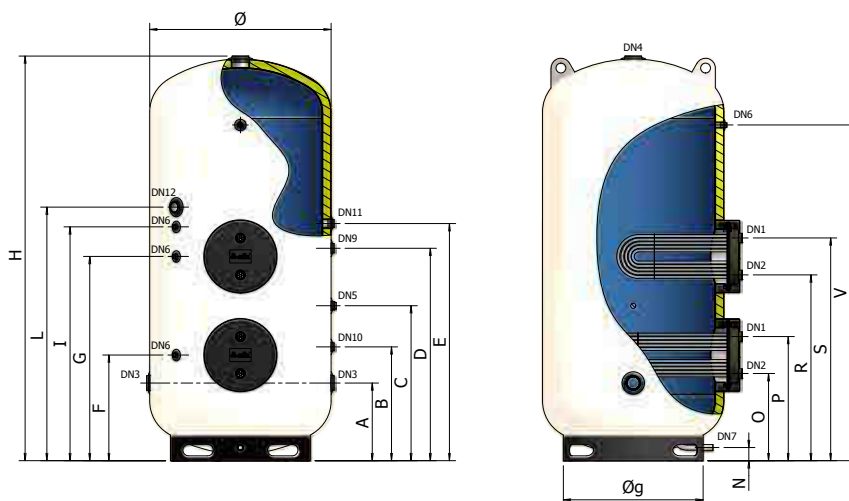

KEYWORD

DN1: Primary fluid inlet (heat exchanger side); **DN2:** Primary fluid outlet (heat exchanger side); **DN3:** Sanitary cold water inlet; **DN4:** Sanitary hot water outlet; **DN5:** Magnesium anode; **DN6:** Probe; **DN7:** Tank drain; **DN8:** Thermo-regulation; **DN9:** Recirculation; **DN10:** Sanitary expansion tank; **DN11:** Extra optional Magnesium Anode; **DN12:** Extra optional heating element;

CYLINDER

FOR SANITARY HOT WATER

SUITABLE FOR SOLAR SYSTEMS

MAGNESIUM ANODE

INTERNAL, GLASSLINING ANTI-CORROSION TREATMENT

POLYURETHANE INSULATION

HEAT EXCHANGER IN STAINLESS STEEL AISI 304

HANDLING BY FORKLIFT

+ 95°C WORKING TEMPERATURE

+110°C HEAT EXCHANGER MAX TEMPERATURE

P_{MAX} 6 bar
MAX WORKING PRESSURE

P_{SCA} 12 bar
HEAT EXCHANGER MAX PRESSURE

WARRANTY: 5 YEARS

REFERENCE STANDARDS

CYLINDER:

2014/68/UE Directive - ART. 4.3, without CE marking
Ecodesign 2009/125/EC

INTERNAL GLASSLINING:

DIN 4753

The glasslining treatment makes the cylinder suitable to contain hot water for sanitary and hygienic use and resistant to corrosive phenomena.

INSULATION:

Expanded, flexible polyurethane with open cells.

HEAT EXCHANGER:

Removable U pipe stainless steel heat exchanger.

INSTALLATION:

- traditional boilers (wall-hung and/or floor-standing)
- condensing boilers
- solar thermal systems

MODEL	CODE	EXCHANGER							NOTES
		LOWER		CENTRAL					
		LITRES	m ²	LITRES	m ²	LITRES	mm	mm	
BF-2 / 1500	A370H67 VW050	1500	4,00	18	3,00	15	1100	2465	
BF-2 / 2000	A370H70 VW050	2000	4,00	18	4,00	18	1200	2445	
BF-2 / 3000	A370H74 VW050	3000	6,00	24	6,00	24	1350	2840	
BF-2 / 5000	A370H80 VW050	5000	10,00	39	10,00	39	1700	3045	

MODEL	ANODE ø x ø conn. x L	DN 1	DN 2	DN 3	DN 4	DN 5	DN 6	DN 7	DN 8	DN 9	DN 10	DN 11	DN 12
		BF-2 / 1500	32 x 1.1/4" x 670	1.1/2"	1.1/2"	2.1/2"	3"	1.1/4"	1/2"	1"	-	1.1/2"	1.1/4"
BF-2 / 2000	32 x 1.1/4" x 670	1.1/2"	1.1/2"	2.1/2"	3"	1.1/4"	1/2"	1"	-	1.1/2"	1.1/4"	1.1/4"	2"
BF-2 / 3000	32 x 1.1/4" x 700	1.1/2"	1.1/2"	3"	3"	1.1/4"	1/2"	1"	-	1.1/2"	1.1/4"	1.1/4"	2"
BF-2 / 5000	40 x 1.1/2" x 640	1.1/2"	1.1/2"	3"	3"	1.1/2"	1/2"	1"	-	1.1/2"	1.1/4"	1.1/2"	2"

MODEL	A mm	B mm	C mm	D mm	E mm	F mm	G mm	I mm	L mm	M mm	N mm	O mm	P mm	Q mm	R mm	S mm	T mm	U mm	V mm
BF-2 / 1500	475	695	945	1295	1445	645	1245	1425	1545	-	80	530	755	-	1130	1355	-	-	2045
BF-2 / 2000	465	685	935	1285	1435	635	1235	1415	1535	-	80	520	745	-	1120	1345	-	-	2035
BF-2 / 3000	530	730	980	1480	1630	680	1280	1520	1730	-	80	565	790	-	1165	1390	-	-	2380
BF-2 / 5000	635	835	1085	1585	1735	785	1385	1625	1835	-	80	670	895	-	1270	1495	-	-	2485

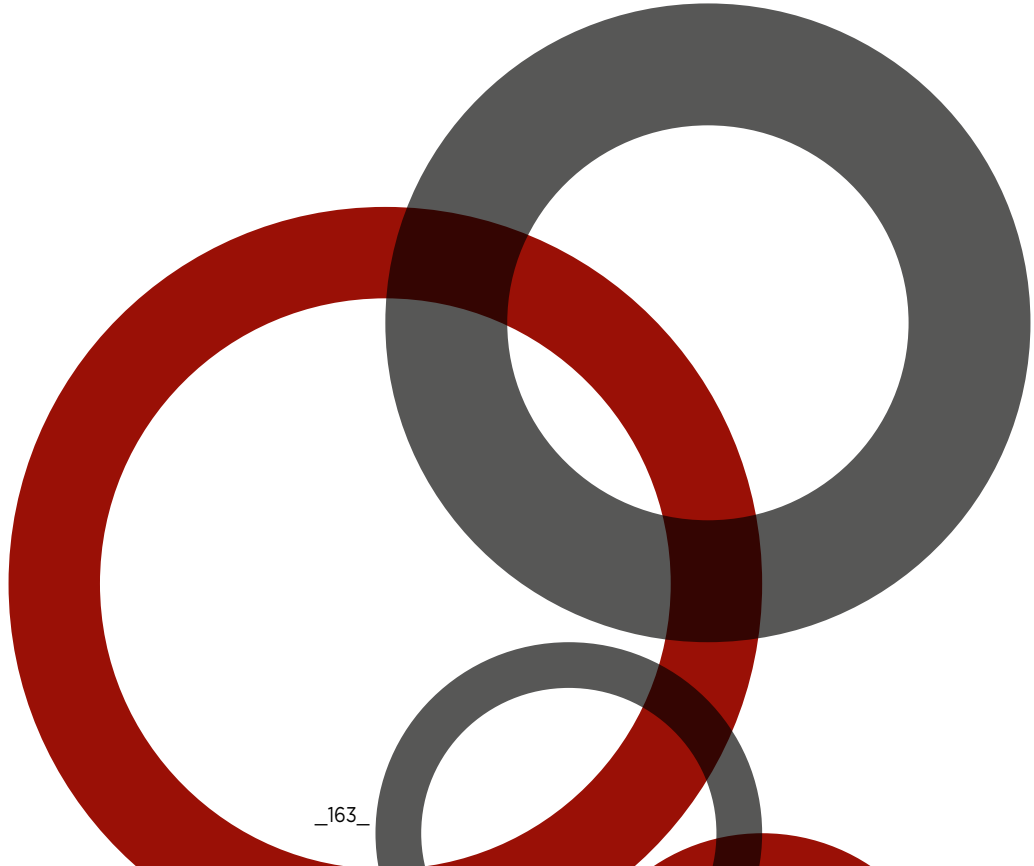

TECHNICAL CHARACTERISTICS

HEAT EXCHANGER	CODE	MAXIMUM WORKING PRESSURE / MAXIMUM WORKING TEMPERATURE			PRESSURE DROP OF HEAT EXCHANGERS
		HOT WATER 12 BAR / 110 °C	SATURATED STEAM 1 BAR / 120 °C	SATURATED STEAM 2 BAR / 134 °C	
3,0 m ²	2950300 V0010	•	•	•	200 mBar
4,0 m ²	2950400 V0010	•	•	•	220 mBar
6,0 m ²	2860600 V0010	•	•	•	350 mBar
10,0 m ²	2964000 V0010	•	•	n.a.	400 mBar

N.B. If using the heat exchanger with temperatures over 100 °C, ask for steam seals

MODEL	INSULATION TYPE	INSULATION THICKNESS	INSULATION DENSITY	INITIAL THERMAL CONDUCTIVITY	(*) INSULATION THERMAL LOSS	EXTERNAL FINISH
BF-2 / 1500	Flexible, expanded polyurethane with open cells	50 mm	15 kg/m ³	39 mW/m K	9,969 kWh / 24h	Skay white RAL 9001
BF-2 / 2000					10,865 kWh / 24h	
BF-2 / 3000					13,799 kWh / 24h	
BF-2 / 5000					18,264 kWh / 24h	

(*) Thermal loss calculated with an accumulation temperature equal to 65 °C and with an external temperature equal to 20 °C.

SAFETY DEVICES

The cylinders must be protected against the effects of over pressure by installing:

- A **SAFETY VALVE** calibrated to pressure below the max pressure of the cylinder
- A **SANITARY EXPANSION TANK** mod. ELBI **D - DV series**

MODEL	RECOMMENDED SANITARY EXPANSION TANK (mod. ELBI D-DV series)
BF-2 / 1500	DV - 150
BF-2 / 2000	DV - 150
BF-2 / 3000	DV - 300
BF-2 / 5000	n°2 pcs DV - 200

Sized using the following parameters: T. accumulation= 85 °C / T. inlet = 15 °C / Pre-charge pressure = 3 bar / Max pressure = 6 bar
The recommended capacity must be verified on the basis of the actual dimensions of the system implemented.

MODEL	MAGNESIUM ANODE SUPPLIED	CATHODIC PROTECTION APPLICABLE
BF-2 / 1500	1,1/4" x 670 / Cod.8560070	Cathodic protection for cylinders 1500/2000 l. Code 8560180
BF-2 / 2000	1,1/4" x 670 / Cod.8560070	
BF-2 / 3000	1,1/4" x 700 / Cod.8560080	Cathodic protection for cylinders 3000/5000 l. Code 8560185
BF-2 / 5000	1,1/2" x 640 / Cod.8560100	

ACCUMULATION AT 60 °C

HEAT EXCHANGER: T.inlet = 80°C; ΔT = 10°C.

STORAGE WATER HEATER: T.inlet =15°C; T. accumulation = 60°C

OPERATION WITH HOT WATER

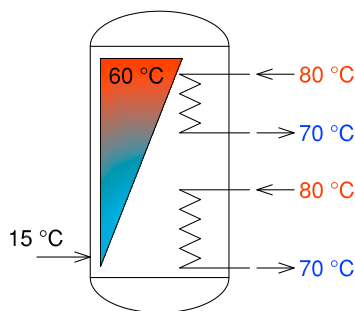

MODEL	HEAT EXCHANGER [m ²]	THERMAL POWER [kW]	PUMP CAPACITY [l/hour]	HEATING TIME ⁽¹⁾ [min]	PRODUCTION DHW AT 60°C [l/hour]	Quantity DHW AT 45°C in first 10 min ⁽²⁾ [l]
BF-2 / 1500	3,0	72,00	6400	30	3203	1822
	4,0	98,00	8500			
BF-2 / 2000	4,0	98,00	8500	32	3656	2230
	4,0	98,00	8500			
BF-2 / 3000	6,0	159,30	14100	29	6088	3607
	6,0	159,30	14100			
BF-2 / 5000	10,0	250,70	22000	31	9580	5715
	10,0	250,70	22000			

(1) Time required to bring the temperature of the cylinder from 15 °C to 60 °C.

(2) Quantity of DHW (Sanitary Hot Water) at 45°C available in the first 10 minutes with DHW accumulation at 60° C.

ACCUMULATION AT 45 °C

HEAT EXCHANGER: T.inlet = 80°C; ΔT = 10°C.

STORAGE WATER HEATER: T.inlet =15°C; T. accumulation = 45°C

OPERATION WITH HOT WATER

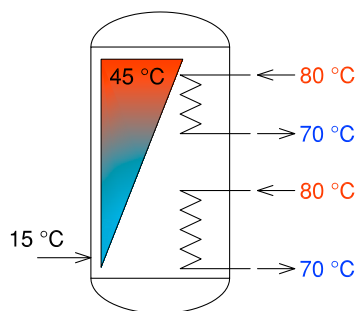

MODEL	HEAT EXCHANGER [m ²]	THERMAL POWER [kW]	PUMP CAPACITY [l/hour]	HEATING TIME ⁽¹⁾ [min]	PRODUCTION DHW AT 45°C [l/hour]
BF-2 / 1500	3,0	92,00/	8100	16	6135
	4,0	131,60	11600		
BF-2 / 2000	4,0	131,60	11600/	16	7540
	4,0	131,60	11600		
BF-2 / 3000	6,0	223,60	19710	14	12820
	6,0	223,60	19710		
BF-2 / 5000	10,0	339,00	29900	16	19440
	10,0	339,00	29900		

(1) Time required to bring the temperature of the cylinder from 15 °C to 45 °C

TABLE OF HEATING ELEMENT APPLICABILITY TO CYLINDERS

Heating element model					Water heating time from 15° C to 60 °C (expressed in minutes) <i>The heating times outlined are approximate</i>			
CODE	Power (kW)	Voltage (Volt)	Connection	Length (mm)	BF-2 1500	BF-2 2000	BF-2 3000	BF-2 5000
8601000	1	220 V / MF	G 1.1/4"	295	4720 min.	6300 min.	9420 min.	15750 min.
8601650	1.65	220 V / MF	G 1.1/4"	450	2870 min.	3820 min.	5740 min.	9550 min.
8602000	2	220 V / MF	G 1.1/4"	515	2370 min.	3150 min.	4740 min.	7875 min.
8602600	2.6	220 V / MF	G 1.1/4"	675	1830 min.	2450 min.	3660 min.	6125 min.
8602601	2.6	220 V / MF	G 1.1/4"	360	1830 min.	2450 min.	3660 min.	6125 min.
8603300	3.3	220 V / MF	G 1.1/4"	825	1450 min.	1940 min.	2900 min.	4850 min.
8603301	3.3	220 V / MF	G 1.1/4"	435	1450 min.	1940 min.	2900 min.	4850 min.
8604001	4	220 V / MF	G 1.1/4"	510	1200 min.	1600 min.	2400 min.	4000 min.
8705000	5	380 V / TF	G 1.1/2"	445	950 min.	1300 min.	1900 min.	3250 min.
8706000	6	380 V / TF	G 1.1/2"	510	800 min.	1060 min.	1600 min.	2650 min.
8708000	8	380 V / TF	G 1.1/2"	670	610 min.	800 min.	1220 min.	2000 min.
8710000	10	380 V / TF	G 1.1/2"	820	490 min.	640 min.	980 min.	1600 min.
8712000	12	380 V / TF	G 1.1/2"	970	410 min.	540 min.	820 min.	1350 min.

n.a. =Heating element not applicable

SEE TABLE OF SYMBOLS
IN THE SHUTTER OF THE
COVER

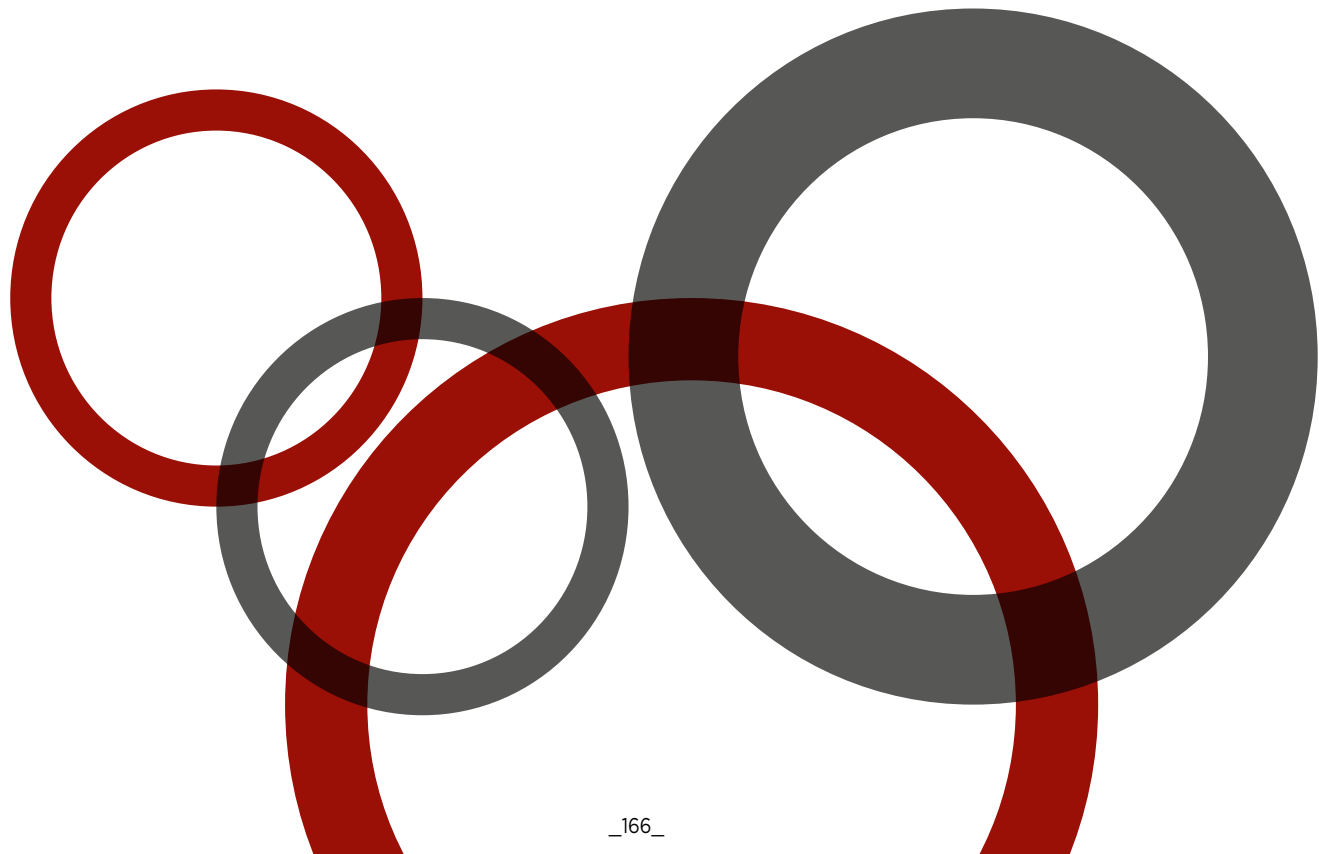
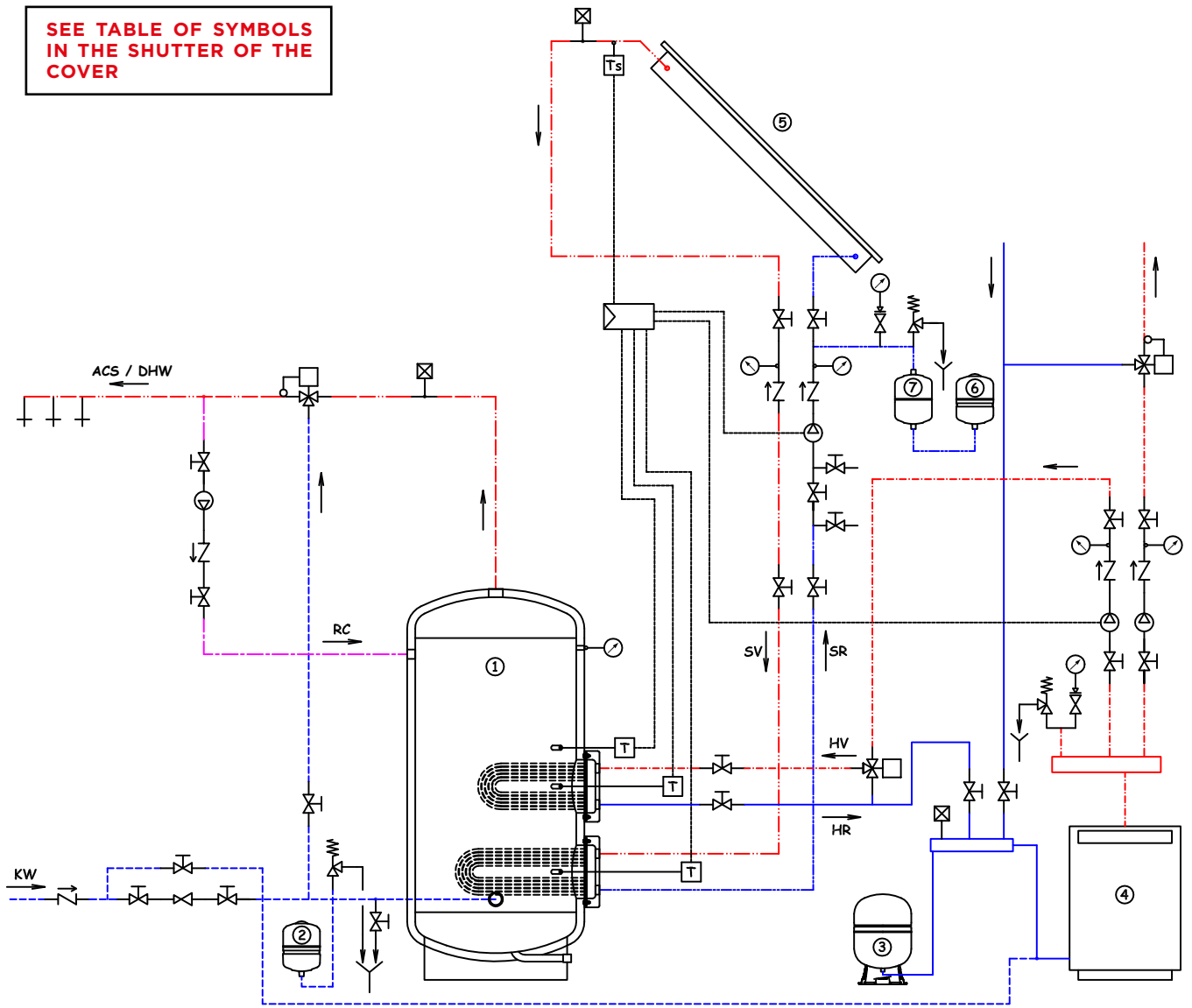





BF3

GLASSLINED CYLINDERS

WITH THREE REMOVABLE STAINLESS STEEL HEAT EXCHANGERS (1.500 - 5.000 LITRES)



BF3 1500 - 2000 - 3000 - 5000

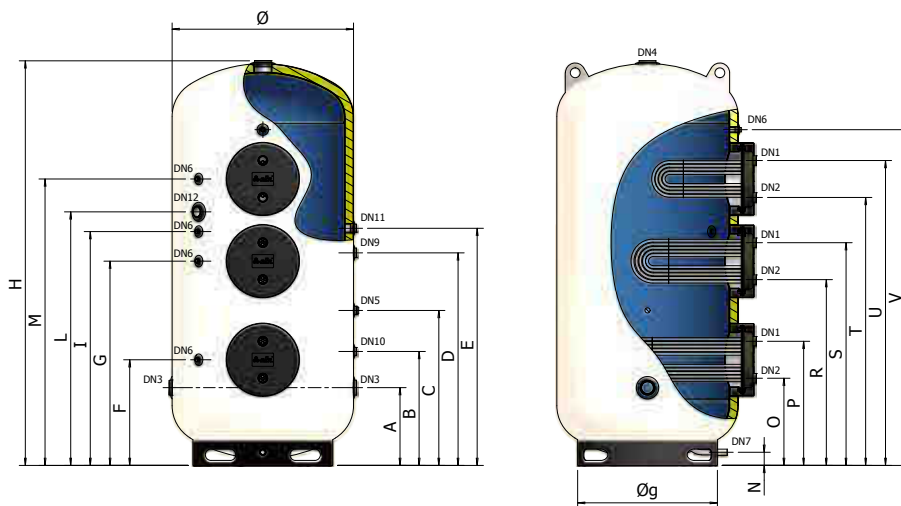

KEYWORD

DN1: Primary fluid inlet (heat exchanger side); **DN2:** Primary fluid outlet (heat exchanger side); **DN3:** Sanitary cold water inlet; **DN4:** Sanitary hot water outlet; **DN5:** Magnesium anode; **DN6:** Probes; **DN7:** Tank drain; **DN8:** Thermo-regulation; **DN9:** Recirculation; **DN10:** Sanitary expansion tank; **DN11:** Extra optional Magnesium Anode; **DN12:** Extra optional heating element;



CYLINDER



FOR SANITARY HOT WATER



SUITABLE FOR SOLAR SYSTEMS



MAGNESIUM ANODE



INTERNAL GLASSLINING ANTI-CORROSION TREATMENT



POLYURETHANE INSULATION



HEAT EXCHANGER IN STAINLESS STEEL AISI 304



HANDLING BY FORKLIFT



+ 95°C
WORKING TEMPERATURE



+110°C
HEAT EXCHANGER MAX TEMPERATURE

P_{MAX} 6 bar
MAX WORKING PRESSURE

P_{SECA} 12 bar
HEAT EXCHANGER MAX PRESSURE

WARRANTY: 5 YEARS

REFERENCE STANDARDS

CYLINDER:

2014/68/UE Directive - ART. 4.3, without CE marking
Ecodesign 2009/125/EC

INTERNAL GLASSLINING:

DIN 4753

The glasslining treatment makes the cylinder suitable to contain hot water for sanitary and hygienic use and resistant to corrosive phenomena.

INSULATION:

Expanded, flexible polyurethane with open cells.

HEAT EXCHANGER:

Removable U pipe stainless steel heat exchanger.

INSTALLATION:

- traditional boilers (wall-hung and/or floor-standing)
- condensing boilers
- solar thermal systems

MODEL	CODE	LITRES	EXCHANGER						mm	mm	NOTES
			LOWER		CENTRAL		UPPER				
			m ²	LITRES	m ²	LITRES	m ²	LITRES			
BF-3 / 1500	A380H67 VW050	1500	4,00	18	3,00	15	1,60	7,5	1100	2465	
BF-3 / 2000	A380H70 VW050	2000	4,00	18	4,00	18	2,50	12,5	1200	2445	
BF-3 / 3000	A380H74 VW050	3000	6,00	24	6,00	24	3,00	15	1350	2840	
BF-3 / 5000	A380H80 VW050	5000	10,00	39	10,00	39	5,00	21	1700	3045	

MODEL	ANODE ø x ø conn. x L	DN	DN	DN	DN	DN	DN	DN	DN	DN	DN	DN	DN
		1	2	3	4	5	6	7	8	9	10	11	12
BF-3 / 1500	32 x 1.1/4" x 670	1.1/2"	1.1/2"	2.1/2"	3"	1.1/4"	1/2"	1"	-	1.1/2"	1.1/4"	1.1/4"	2"
BF-3 / 2000	32 x 1.1/4" x 670	1.1/2"	1.1/2"	2.1/2"	3"	1.1/4"	1/2"	1"	-	1.1/2"	1.1/4"	1.1/4"	2"
BF-3 / 3000	32 x 1.1/4" x 700	1.1/2"	1.1/2"	3"	3"	1.1/4"	1/2"	1"	-	1.1/2"	1.1/4"	1.1/4"	2"
BF-3 / 5000	40 x 1.1/2" x 640	1.1/2"	1.1/2"	3"	3"	1.1/2"	1/2"	1"	-	1.1/2"	1.1/4"	1.1/2"	2"

MODEL	A	B	C	D	E	F	G	I	L	M	N	O	P	Q	R	S	T	U	V
	mm	mm	mm	mm	mm	mm	mm	mm	mm	mm	mm	mm	mm	mm	mm	mm	mm	mm	mm
BF-3 / 1500	475	695	945	1295	1445	645	1245	1425	1545	1745	80	530	755	-	1130	1355	1630	1855	2045
BF-3 / 2000	465	685	935	1285	1435	635	1235	1415	1535	1735	80	520	745	-	1120	1345	1620	1845	2035
BF-3 / 3000	530	730	980	1480	1630	680	1280	1520	1730	1930	80	565	790	-	1165	1390	1815	2040	2380
BF-3 / 5000	635	835	1085	1585	1735	785	1385	1625	1835	2035	80	670	895	-	1270	1495	1920	2145	2485

TECHNICAL CHARACTERISTICS

HEAT EXCHANGER	CODE	MAXIMUM WORKING PRESSURE / MAXIMUM WORKING TEMPERATURE				PRESSURE DROP OF HEAT EXCHANGERS
		HOT WATER 12 BAR / 110 °C	SATURATED STEAM 1 BAR / 120 °C	SATURATED STEAM 2 BAR / 134 °C	SATURATED STEAM 4 BAR / 152 °C	
1,6 m ²	2950150 V0010	●	●	●	●	80 mBar
2,5 m ²	2960250 V0010	●	●	●	●	110 mBar
3,0 m ²	2950300 V0010	●	●	●	n.a.	200 mBar
4,0 m ²	2950400 V0010	●	●	●	n.a.	220 mBar
5,0 m ²	2960500 V0010	●	●	●	n.a.	270 mBar
6,0 m ²	2960600 V0010	●	●	●	n.a.	350 mBar
10,0 m ²	2961000 V0010	●	●	n.a.	n.a.	400 mBar

N.B. If using the heat exchanger with temperatures over 100 °C, ask for steam seals

MODEL	INSULATION TYPE	INSULATION THICKNESS	INSULATION DENSITY	INITIAL THERMAL CONDUCTIVITY	(*) INSULATION THERMAL LOSS	EXTERNAL FINISH
BF-3 / 1500	Flexible, expanded polyurethane with open cells	50 mm	15 kg/m ³	39 mW/m K	9,969 kWh / 24h	Skay white RAL 9001
BF-3 / 2000					10,865 kWh / 24h	
BF-3 / 3000					13,799 kWh / 24h	
BF-3 / 5000					18,264 kWh / 24h	

(*) Thermal loss calculated with an accumulation temperature equal to 65 °C and with an external temperature equal to 20 °C.

SAFETY DEVICES

The cylinders must be protected against the effects of over pressure by installing:

- A **SAFETY VALVE** calibrated to pressure below the max pressure of the cylinder
- A **SANITARY EXPANSION TANK** mod. ELBI **D - DV series**

MODEL	RECOMMENDED SANITARY EXPANSION TANK (mod. ELBI D-DV series)
BF-3 / 1500	DV - 150
BF-3 / 2000	DV - 150
BF-3 / 3000	DV - 300
BF-3 / 5000	n°2 pcs DV - 200

Sized using the following parameters: T. accumulation= 85 °C / T. inlet = 15 °C / Pre-charge pressure = 3 bar / Max pressure = 6 bar
The recommended capacity must be verified on the basis of the actual dimensions of the system implemented

MODEL	MAGNESIUM ANODE SUPPLIED	CATHODIC PROTECTION APPLICABLE
BF-3 / 1500	1,1/4" x 670 / Cod.8560070	Cathodic protection for cylinders 1500/2000 l Code 8560180
BF-3 / 2000	1,1/4" x 670 / Cod.8560070	
BF-3 / 3000	1,1/4" x 700 / Cod.8560080	Cathodic protection for cylinders 3000/5000 l. Code 8560185
BF-3 / 5000	1,1/2" x 640 / Cod.8560100	

ACCUMULATION AT 60 °C

HEAT EXCHANGER: T.inlet = 80°C; ΔT = 10°C.

STORAGE WATER HEATER: T.inlet =15°C; T. accumulation = 60°C

OPERATION WITH HOT WATER

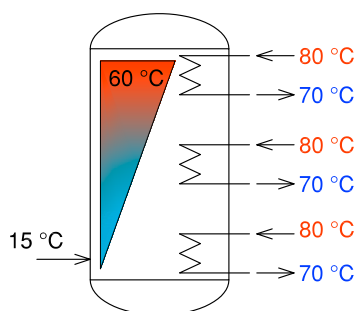

MODEL	HEAT EXCHANGER [m²]	THERMAL POWER [kW]	PUMP CAPACITY [l/hour]	HEATING TIME ⁽¹⁾ [min]	PRODUCTION DHW AT 60°C [l/hour]	QUANTITY DHW AT 45°C in first 10 min. ⁽²⁾ [l]
BF-3 / 1500	1,6	40,60	3580	42	775	1084
	3,0	72,00	6400			
	4,0	98,00	8500	30	3203	1825
BF-3 / 2000	2,5	54,00	4760	38	1030	1362
	4,0	98,00	8500			
	4,0	98,00	8500	32	3656	2220
BF-3 / 3000	3,0	72,00	6400	46	1375	1895
	6,0	159,30	14100			
	6,0	159,30	14100	29	6088	3592
BF-3 / 5000	5,0	115,00	10150	47	2197	3228
	10,0	250,70	22000			
	10,0	250,70	22000	31	9580	5705

(1) Time required to bring the temperature of the cylinder from 15 °C to 60 °C.

(2) Quantity of DHW (Sanitary Hot Water) at 45°C available in the first 10 minutes with DHW accumulation at 60° C.

ACCUMULATION AT 45 °C

HEAT EXCHANGER: T.inlet = 80°C; ΔT = 10°C.

STORAGE WATER HEATER: T.inlet =15°C; T. accumulation = 45°C

OPERATION WITH HOT WATER

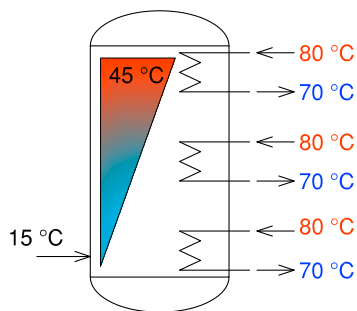

MODEL	HEAT EXCHANGER [m²]	THERMAL POWER [kW]	PUMP CAPACITY [l/hour]	HEATING TIME ⁽¹⁾ [min]	PRODUCTION DHW AT 45°C [l/hour]
BF-3 / 1500	1,6	59,20	5230	20	1690
	3,0	92,00	8100		
	4,0	131,60	11600	16	6135
BF-3 / 2000	2,5	78,00	6900	18	2230
	4,0	131,60	11600		
	4,0	131,60	11600	16	7540
BF-3 / 3000	3,0	91,90	8140	24	2635
	6,0	223,60	19710		
	6,0	223,60	19710	14	12820
BF-3 / 5000	5,0	160,00	14000	23	4580
	10,0	339,00	29900		
	10,0	339,00	29900	16	19440

(1) Time required to bring the temperature of the cylinder from 15 °C to 45 °C.

TABLE OF HEATING ELEMENT APPLICABILITY TO CYLINDERS

Heating element model*					Water heating time from 15° C to 60 °C (expressed in minutes) <i>The heating times outlined are approximate</i>			
CODE	Power (kW)	Voltage (Volt)	Connection	Length (mm)	BF-3 1500	BF-3 2000	BF-3 3000	BF-3 5000
8601000	1	220 V / MF	G 1.1/4"	295	4720 min.	6300 min.	9420 min.	15750 min.
8601650	1.65	220 V / MF	G 1.1/4"	450	2870 min.	3820 min.	5740 min.	9550 min.
8602000	2	220 V / MF	G 1.1/4"	515	2370 min.	3150 min.	4740 min.	7875 min.
8602600	2.6	220 V / MF	G 1.1/4"	675	1830 min.	2450 min.	3660 min.	6125 min.
8602601	2.6	220 V / MF	G 1.1/4"	360	1830 min.	2450 min.	3660 min.	6125 min.
8603300	3.3	220 V / MF	G 1.1/4"	825	1450 min.	1940 min.	2900 min.	4850 min.
8603301	3.3	220 V / MF	G 1.1/4"	435	1450 min.	1940 min.	2900 min.	4850 min.
8604001	4	220 V / MF	G 1.1/4"	510	1200 min.	1600 min.	2400 min.	4000 min.
8705000	5	380 V / TF	G 1.1/2"	445	950 min.	1300 min.	1900 min.	3250 min.
8706000	6	380 V / TF	G 1.1/2"	510	800 min.	1060 min.	1600 min.	2650 min.
8708000	8	380 V / TF	G 1.1/2"	670	610 min.	800 min.	1220 min.	2000 min.
8710000	10	380 V / TF	G 1.1/2"	820	490 min.	640 min.	980 min.	1600 min.
8712000	12	380 V / TF	G 1.1/2"	970	410 min.	540 min.	820 min.	1350 min.

n.a. =Heating element not applicable

SEE TABLE OF SYMBOLS
IN THE SHUTTER OF THE
COVER

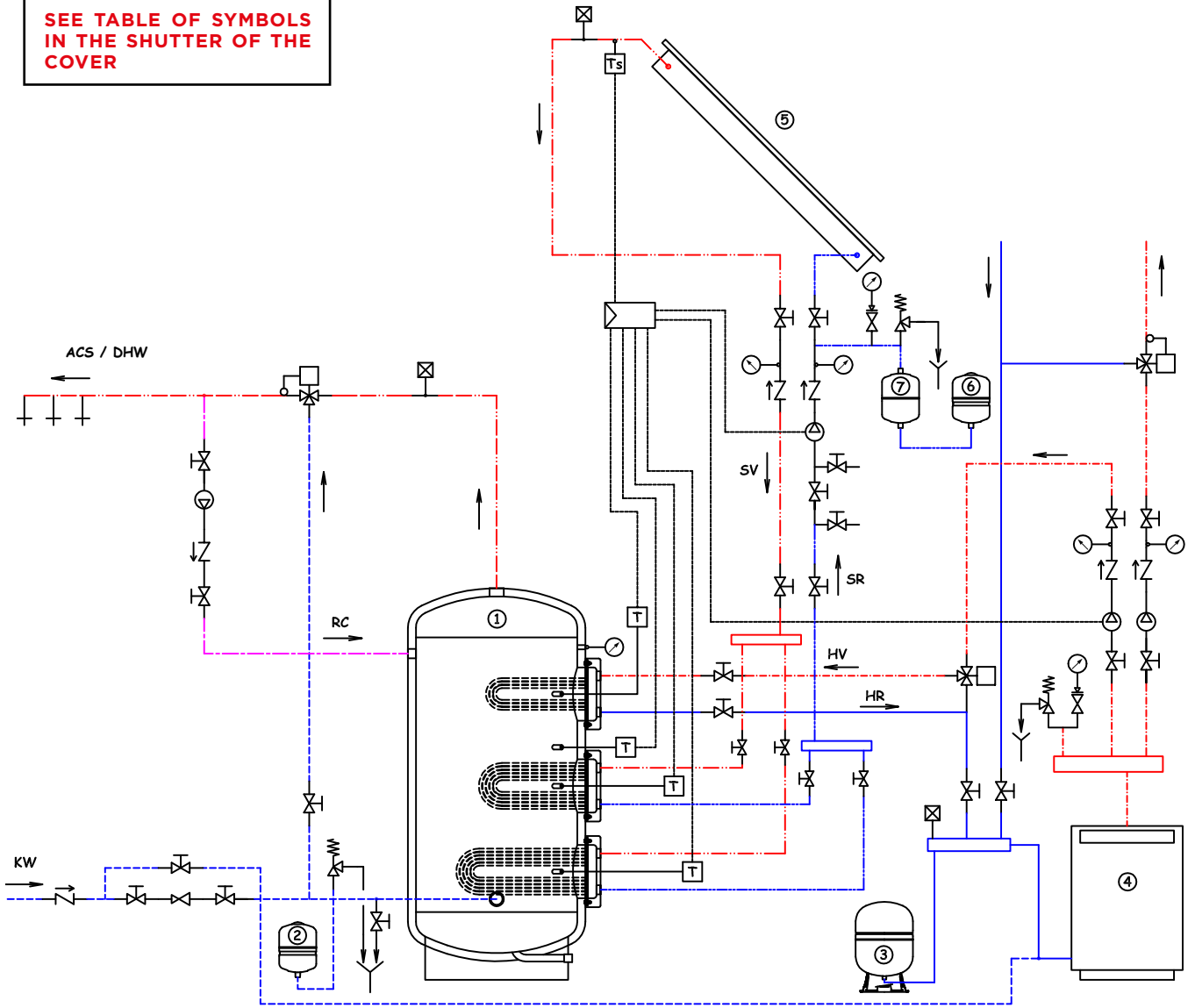





BG

MULTI-PURPOSE GLASSLINED BUFFER TANKS

WITH TRIPLE FLANGED OPENINGS (800 - 5.000 LITRES)

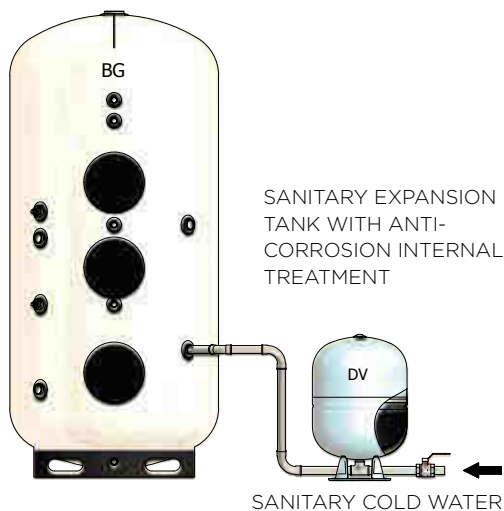

BG 800 - 1000

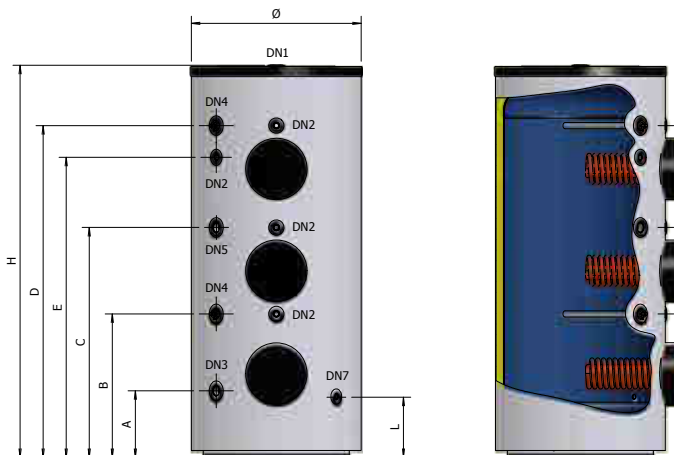

BG 1500 - 2000 - 3000 - 5000

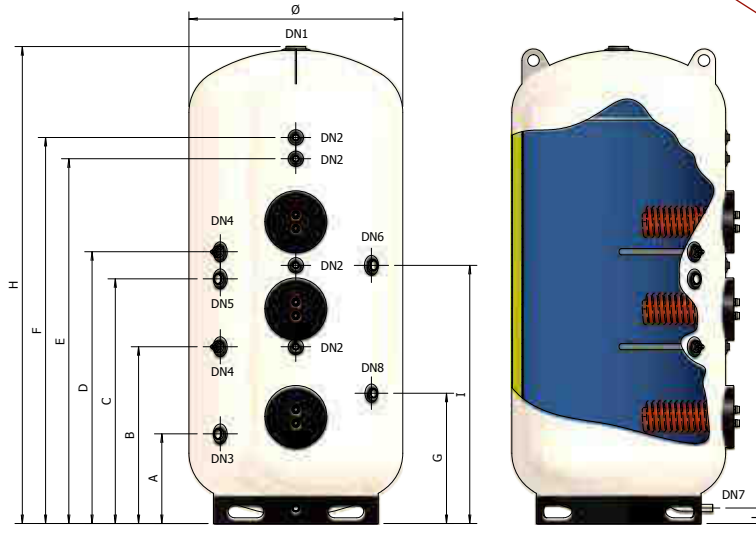

NOTES: heat exchanger is **NOT** standard supplied.

KEYWORD

DN1: Sanitary hot water outlet; **DN2:** Probes (Thermometer, Thermostat); **DN3:** Sanitary cold water inlet; **DN4:** Magnesium anode; **DN5:** Heating element; **DN6:** Recirculation; **DN7:** Tank drain; **DN8:** Sanitary expansion tank connection.



CYLINDER



FOR SANITARY HOT WATER



SUITABLE FOR SOLAR SYSTEMS



MAGNESIUM ANODE WITH SIMPLETEST



INTERNAL, GLASSLINING ANTI-CORROSION TREATMENT



POLYURETHANE INSULATION



+ 95°C WORKING TEMPERATURE



+ 110°C HEAT EXCHANGER MAX TEMPERATURE

P_{MAX} 10 bar MAX WORKING PRESSURE

P_{SCA} 12 bar HEAT EXCHANGER MAX PRESSURE

REFERENCE STANDARDS

CYLINDER:

2014/68/UE Directive - ART. 4.3, without CE marking
Ecodesign 2009/125/EC

INTERNAL GLASSLINING:

DIN 4753

The glasslining treatment makes the cylinder suitable to contain hot water for sanitary and hygienic use and resistant to corrosive phenomena.

WARRANTY: 5 YEARS

INSULATION:

Expanded polyurethane without CFC and HCFC up to 1000L
Expanded flexible polyurethane with open cells.

HEAT EXCHANGER:

Removable coil in finned copper (optional).
See accessories on page 230

INSTALLATION:

- traditional boilers (wall-hung and/or floor-standing)
- condensing boilers
- solar thermal systems

DIMENSIONS

MODEL	CODE				NOTES
		LITRES	mm	mm	
BG-800	A3FOL60 P9016	800	900	1795	
BG-1000	A3FOL62 P9016	1000	900	2045	
BG-1500	A3FOH67 VW050	1500	1100	2460	
BG-2000	A3FOH70 VW050	2000	1200	2445	
BG-3000	A3FOH74 VW050	3000	1350	2840	
BG-5000	A3FOH80 VW050	5000	1700	3040	

MODEL	ANODE Ø x Ø conn. x L	DN1	DN2	DN3	DN4	DN5	DN6	DN7	DN8
		BG-800	n°2 32 x 1.1/2" x 550	1.1/2"	3/4"	1.1/2"	1.1/2"	1.1/2"	/
BG-1000	n°2 32 x 1.1/2" x 550	1.1/2"	3/4"	1.1/2"	1.1/2"	1.1/2"	/	3/4"	/
BG-1500	n°2 32 x 1.1/2" x 550	3"	3/4"	1.1/2"	1.1/2"	1.1/2"	1.1/2"	1"	1.1/4"
BG-2000	n°2 32 x 1.1/2" x 550	3"	3/4"	1.1/2"	1.1/2"	1.1/2"	1.1/2"	1"	1.1/4"
BG-3000	n°2 32 x 1.1/2" x 550	3"	3/4"	1.1/2"	1.1/2"	1.1/2"	1.1/2"	1"	1.1/4"
BG-5000	n°2 32 x 1.1/2" x 550	3"	3/4"	1.1/2"	1.1/2"	1.1/2"	1.1/2"	1"	1.1/4"

MODEL	A mm	B mm	C mm	D mm	E mm	F mm	G mm	I mm	L mm
BG-800	345	645	995	1465	1185	/	/	/	320
BG-1000	350	750	1200	1730	1565	/	/	/	320
BG-1500	465	915	1265	1405	1885	1995	675	1335	80
BG-2000	455	905	1255	1395	1875	1985	665	1325	80
BG-3000	500	950	1300	1440	1940	2230	710	1730	80
BG-5000	605	1065	1405	1545	2045	2335	815	1835	80

MODEL	CODE	SURF. m ²	CONNECTIONS	DIMENSIONS ØEXT x L
SC-180	2140180	1,8	3/4"	170X460
SC-250	2140250	2,5	3/4"	170X560
SC-320	2140320	3,2	1.1/4"	190X550
SC-450	2140450	4,5	1.1/4"	190X750

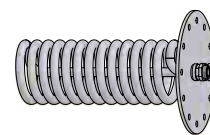

TECHNICAL CHARACTERISTICS

MODEL	MAX WORKING PRESSURE CYLINDER (Secondary circuit)	MAX. WORKING PRESSURE HEAT EXCHANGER (Primary circuit)	PRESSURE DROP BASED ON CAPACITY INSIDE EXCHANGER
BG 800	10 bar	95 °C	
BG 1000			
BG 1500			
BG 2000			
BG 3000			
BG 5000			

MODEL	INSULATION TYPE	INSULATION THICKNESS	INSULATION DENSITY	INITIAL THERMAL CONDUCTIVITY	(*) INSULATION THERMAL LOSS	EXTERNAL FINISH
BG 800	95% closed cells rigid expanded polyurethane, CFC - HCFC free	50 mm	40 kg/m ³	23,5 mW/m K	3,958 kWh / 24h	Grey polystyrene RAL 9006
BG 1000					4,449 kWh / 24h	
BG 1500	Open cells flexible expanded polyurethane	50 mm	15 kg/m ³	39,0 mW/m K	9,969 kWh / 24h	Skay white RAL 9001
BG 2000					10,865 kWh / 24h	
BG 3000					13,799 kWh / 24h	
BG 5000					18,264 kWh / 24h	

(*) Thermal loss calculated with an accumulation temperature equal to 65 °C and with an external temperature equal to 20 °C.

STANDARD EQUIPMENT

- Anode with simpletest

SAFETY DEVICES

The cylinders must be protected against the effects of over pressure by installing:

- A **SAFETY VALVE** calibrated to pressure below the max pressure of the cylinder
- A **SANITARY EXPANSION TANK** mod. ELBI **D - DV series**

MODEL	RECOMMENDED SANITARY EXPANSION TANK (mod. ELBI D-DV series)
BG 800	DV - 50
BG 1000	DV - 80
BG 1500	DV - 150
BG 2000	DV - 150
BG 3000	DV - 300
BG 5000	n°2 pcs DV - 200

Sized using the following parameters: T. accumulation= 85 °C / T. inlet = 15 °C / Pre-charge pressure = 3 bar / Max pressure = 6 bar
The recommended capacity must be verified on the basis of the actual dimensions of the system implemented.

MODEL	MAGNESIUM ANODE SUPPLIED	CATHODIC PROTECTION APPLICABLE
BG 800	n.2 x 1.1/2" x 550 / Cod. 8560065	Cathodic protection for cylinders 500/1000 l. Code 8560175
BG 1000		
BG 1500		Cathodic protection for cylinders 1500/2000 l. Code 8560180
BG 2000		
BG 3000		Cathodic protection for cylinders 3000/5000 l. Code 8560185
BG 5000		

CHARACTERISTIC CURVES ON SPIROIDAL HEAT EXCHANGERS

Choice of heat exchanger:

The graphics show the heat flow transmitted from the heat exchanger referring to a thermal gradient of 1°C between the temperature of the inlet water in the exchanger and the temperature of the cylinder inlet water. The parameter to use is supplied based on:
 · the temperature of the water into the heat exchanger;
 · the capacity of the circulator.

Example:

Heat exchanger model: SC-180
 Cylinder inlet water temperature: 15 °C
 Heat exchanger inlet water temperature: 70 °C
 Circulator capacity: 1.20 m³/h

The capacity of 1.20 m³/h crosses the curve (heat exchanger water inlet) relating to 70°C corresponding to the value 0.52 kW/°C.

For a temperature difference of 55°C (70°C - 15°C) we obtain heat exchanger power of:

$q = 55 \times 0,52 = 28,60 \text{ kW}$

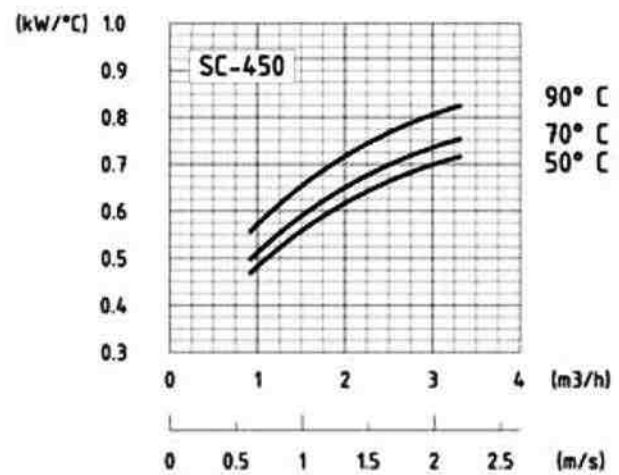
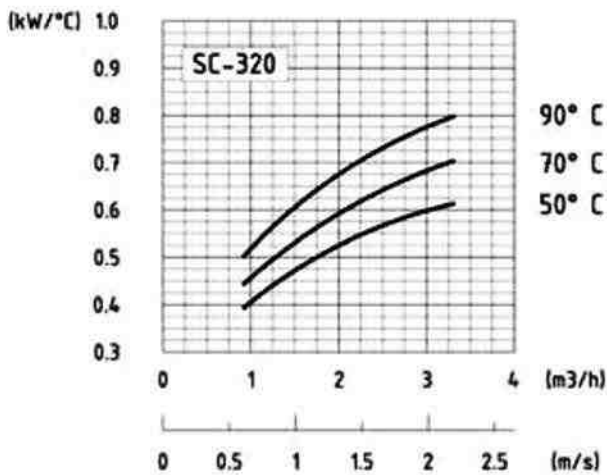
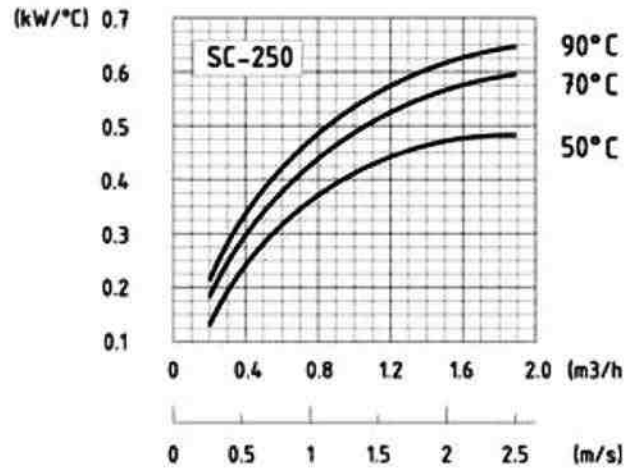
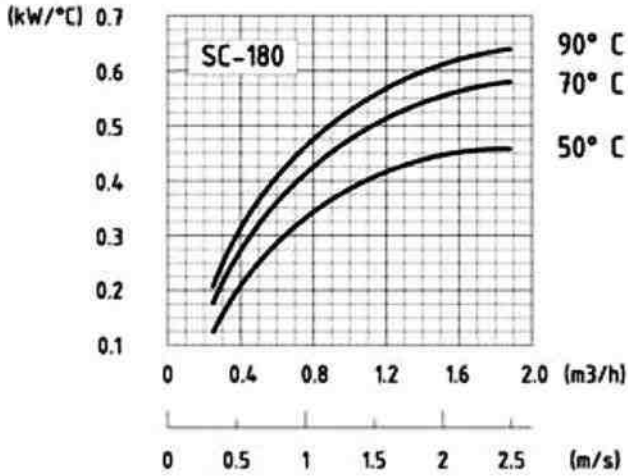
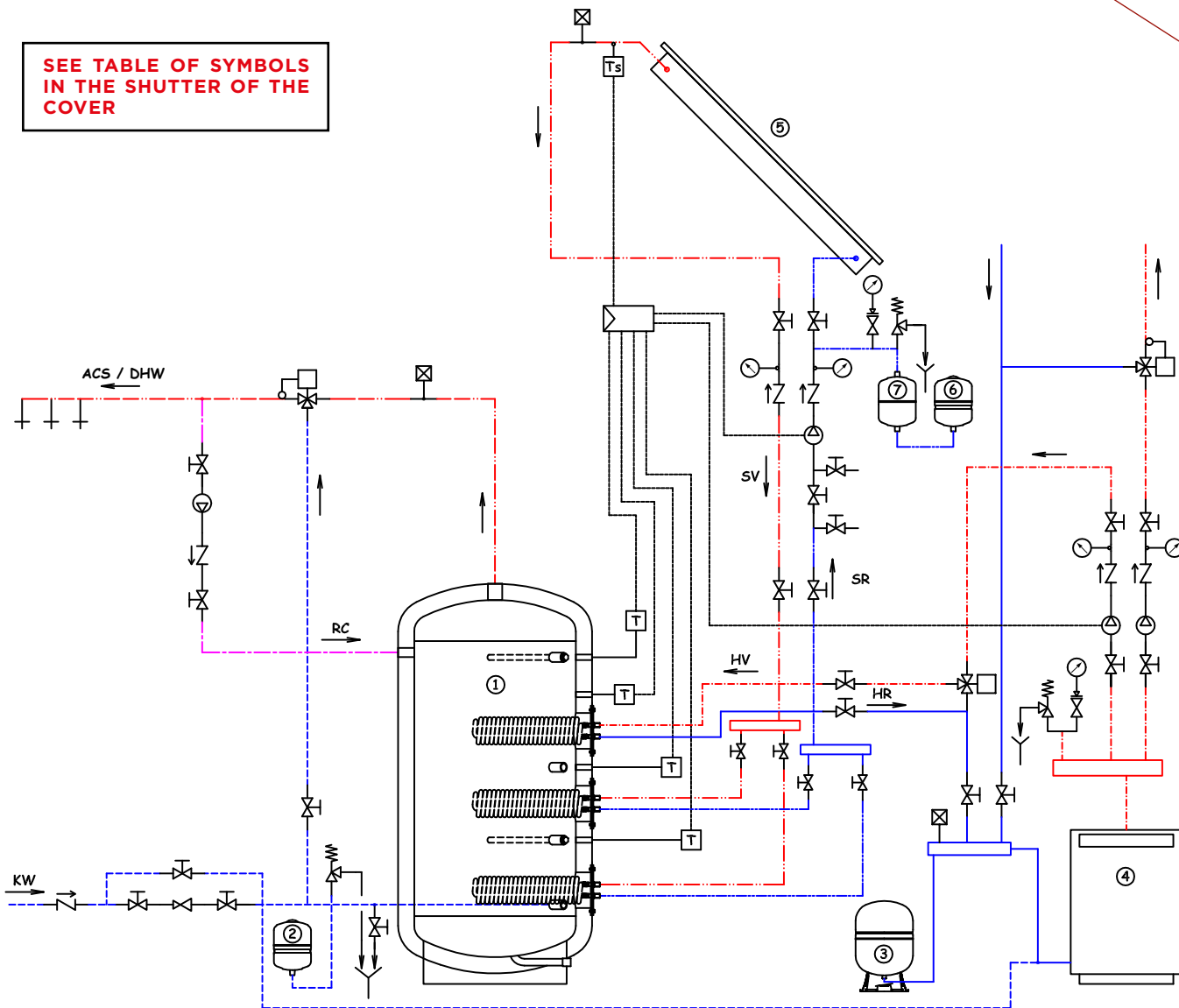

TABLE OF HEATING ELEMENT APPLICABILITY TO CYLINDERS

Heating element model*					Water heating time from 15° C to 60° C (expressed in minutes) <i>The heating times outlined are approximate</i>					
CODE	Power (kW)	Voltage (Volt)	Connection	Length (mm)	BG 800	BG 1000	BG 1500	BG 2000	BG 3000	BG 5000
8601000	1	220 V / MF	G 1.1/4"	295	2520 min.	3150 min.	4720 min.	6300 min.	9420 min.	15750 min.
8601650	1.65	220 V / MF	G 1.1/4"	450	1550 min.	1920 min.	2870 min.	3820 min.	5740 min.	9550 min.
8602000	2	220 V / MF	G 1.1/4"	515	1270 min.	1580 min.	2370 min.	3150 min.	4740 min.	7875 min.
8602600	2.6	220 V / MF	G 1.1/4"	675	980 min.	1230 min.	1830 min.	2450 min.	3660 min.	6125 min.
8602601	2.6	220 V / MF	G 1.1/4"	360	980 min.	1230 min.	1830 min.	2450 min.	3660 min.	6125 min.
8603300	3.3	220 V / MF	G 1.1/4"	825	n.a.	n.a.	1450 min.	1940 min.	2900 min.	4850 min.
8603301	3.3	220 V / MF	G 1.1/4"	435	780 min.	980 min.	1450 min.	1940 min.	2900 min.	4850 min.
8604001	4	220 V / MF	G 1.1/4"	510	640 min.	800 min.	1200 min.	1600 min.	2400 min.	4000 min.
8705000	5	380 V / TF	G 1.1/2"	445	520 min.	640 min.	950 min.	1300 min.	1900 min.	3250 min.
8706000	6	380 V / TF	G 1.1/2"	510	430 min.	540 min.	800 min.	1060 min.	1600 min.	2650 min.
8708000	8	380 V / TF	G 1.1/2"	670	330 min.	420 min.	610 min.	800 min.	1220 min.	2000 min.
8710000	10	380 V / TF	G 1.1/2"	820	n.a.	n.a.	490 min.	640 min.	980 min.	1600 min.
8712000	12	380 V / TF	G 1.1/2"	970	n.a.	n.a.	410 min.	540 min.	820 min.	1350 min.

n.a. = Heating element not applicable

SEE TABLE OF SYMBOLS
IN THE SHUTTER OF THE
COVER



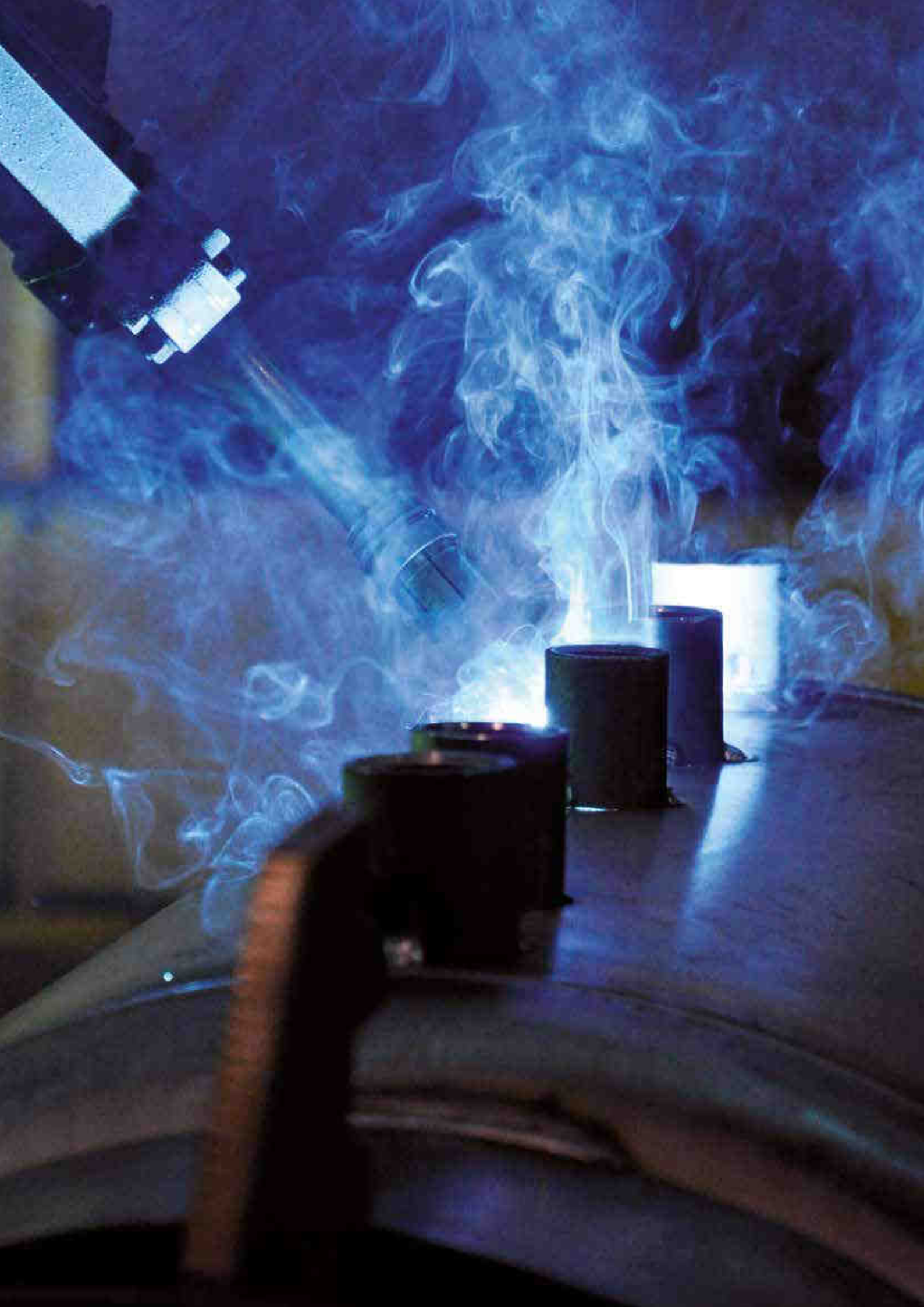



SAC

GLASSLINED ACCUMULATORS
FOR SANITARY HOT WATER (300 - 5.000 LITRES)



SAC 300 - 500 - 800 - 1000

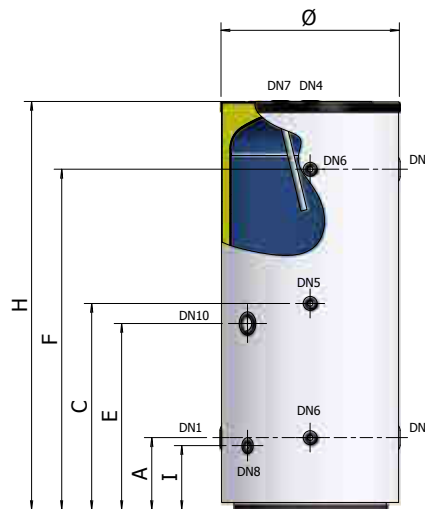
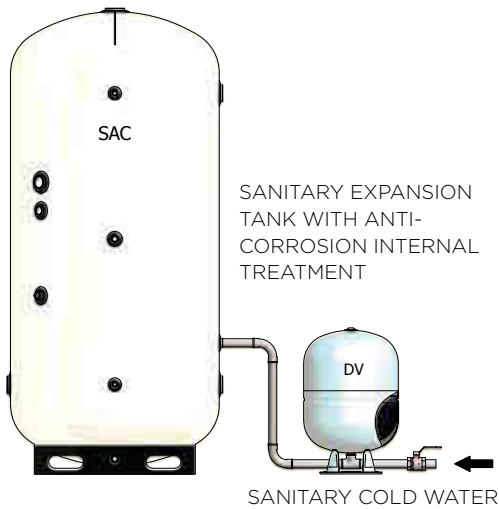

SAC 1500 - 2000 - 3000 - 5000

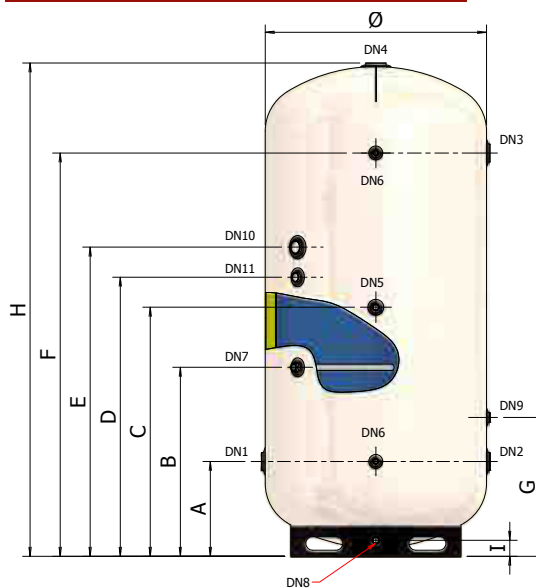

KEYWORD

DN1: Sanitary cold water inlet; **DN2:** Sanitary water outlet (external heat exchanger); **DN3:** Sanitary hot water inlet (from external heat exchanger); **DN4:** Sanitary hot water outlet; **DN5:** Recirculation; **DN6:** Probes; **DN7:** Magnesium anode; **DN8:** Drain; **DN9:** Sanitary expansion tank connection; **DN10:** Heating element; **DN11:** Predisposition for auxiliary magnesium anode.



FOR SANITARY HOT WATER



+ 95°C
WORKING TEMPERATURE



MAGNESIUM ANODE



HANDLING BY FORKLIFT

P_{MAX} 10 bar (300 - 1000)
MAX WORKING PRESSURE



INTERNAL, GLASSLINING
ANTI-CORROSION TREATMENT

P_{MAX} 6 bar (1500 - 5000)
MAX WORKING PRESSURE



POLYURETHANE INSULATION

WARRANTY: 5 YEARS

REFERENCE STANDARDS

ACCUMULATOR:

2014/68/UE Directive - ART. 4.3, without CE marking
Designed and built in accordance with the requirements of the 2009/125/EC.
Labeling in accordance with the requirements of the 2010/30/EU.

INTERNAL GLASSLINING:

DIN 4753
The glasslining treatment makes the accumulator suitable to contain hot water for sanitary and hygienic use and resistant to corrosive phenomena.

INSULATION:

Expanded polyurethane without CFC and HCFC up to 1000L
Expanded flexible polyurethane with open cells

INSTALLATION:

- traditional boilers (wall-hung and/or floor-standing)
- condensing boilers
- solar thermal systems

DIMENSIONS

MODEL	CODE	ENERGY LABEL	LITRES	mm	mm	NOTES
		CL				
SAC-300	A310L51 PGP40	C	300	650	1400	
SAC-500	A310L55 PGP40	D	500	750	1695	
SAC-800	A310L60 PGP40	/	800	900	1780	
SAC-1000	A310L62 PGP40	/	1000	900	2030	
SAC-1500	A310H67 VW050	/	1500	1100	2460	
SAC-2000	A310H70 VW050	/	2000	1200	2445	
SAC-3000	A310H74 VW050	/	3000	1350	2840	
SAC-5000	A310H80 VW050	/	5000	1700	3040	

MODEL	A mm	B mm	C mm	D mm	E mm	F mm	G mm	I mm
SAC-300	280	/	710	/	640	1140	/	245
SAC-500	300	/	855	/	770	1410	/	265
SAC-800	350	/	905	/	860	1460	/	320
SAC-1000	360	/	1030	/	930	1700	/	320
SAC-1500	475	945	1245	1395	1545	2015	695	80
SAC-2000	465	935	1235	1385	1535	2005	685	80
SAC-3000	525	980	1425	1580	1730	2330	730	80
SAC-5000	635	1085	1535	1685	1835	2435	835	80

ANODE

MODEL	Ø x Ø conn. x L	DN1	DN2	DN3	DN4	DN5	DN6	DN7	DN8	DN9	DN10	DN11
SAC-300	32 x 1.1/4" x 350	1.1/4"	1.1/4"	1.1/4"	1.1/4"	3/4"	1/2"	1.1/4"	1/2"	/	2"	/
SAC-500	32 x 1.1/4" x 410	1.1/2"	1.1/2"	1.1/2"	1.1/4"	3/4"	1/2"	1.1/4"	1/2"	/	2"	/
SAC-800	32 x 1.1/4" x 520	1.1/2"	1.1/2"	1.1/2"	1.1/4"	3/4"	1/2"	1.1/4"	3/4"	/	2"	/
SAC-1000	32 x 1.1/4" x 520	2"	2"	2"	1.1/4"	3/4"	1/2"	1.1/4"	3/4"	/	2"	/
SAC-1500	32 x 1.1/4" x 670	2.1/2"	2.1/2"	2.1/2"	3"	3/4"	1/2"	1.1/4"	1"	1.1/4"	2"	1.1/4"
SAC-2000	32 x 1.1/4" x 670	2.1/2"	2.1/2"	2.1/2"	3"	3/4"	1/2"	1.1/4"	1"	1.1/4"	2"	1.1/4"
SAC-3000	32 x 1.1/4" x 700	3"	3"	3"	3"	3/4"	1/2"	1.1/4"	1"	1.1/4"	2"	1.1/4"
SAC-5000	40 x 1.1/2" x 640	3"	3"	3"	3"	3/4"	1/2"	1.1/2"	1"	1.1/4"	2"	1.1/2"

TECHNICAL CHARACTERISTICS

MODEL	MAX WORKING PRESSURE CYLINDER (Secondary circuit)	MAXIMUM WORKING TEMPERATURE
SAC-300	10 bar	95 °C
SAC-500		
SAC-800		
SAC-1000		
SAC-1500	6 bar	95 °C
SAC-2000		
SAC-3000		
SAC-5000		

MODEL	INSULATION TYPE	INSULATION THICKNESS	INSULATION DENSITY	INITIAL THERMAL CONDUCTIVITY	(*) INSULATION THERMAL LOSS	EXTERNAL COVER
SAC 300	95% closed cells rigid expanded polyurethane, CFC - HCFC free	50 mm	40 kg/m ³	23,5 mW/m K	2,208 kWh / 24h	Grey polystyrene RAL 9006
SAC 500					3,192 kWh / 24h	
SAC 800					3,958 kWh / 24h	
SAC 1000					4,449 kWh / 24h	
SAC 1500	Open cells flexible expanded polyurethane	50 mm	15 kg/m ³	39,0 mW/m K	9,969 kWh / 24h	Skay white RAL 9001
SAC 2000					10,856 kWh / 24h	
SAC 3000					13,779 kWh / 24h	
SAC 5000					18,264 kWh / 24h	

(*) Thermal loss calculated with an accumulation temperature equal to 65 °C and with an external temperature equal to 20 °C.

SAFETY DEVICES

- The cylinders must be protected against the effects of over pressure by installing:
- A **SAFETY VALVE** calibrated to pressure below the max pressure of the accumulator
 - A **SANITARY EXPANSION TANK** mod. ELBI **D - DV series**

MODEL	RECOMMENDED SANITARY EXPANSION TANK (mod. ELBI D-DV series)
SAC 300	D - 24
SAC 500	D - 35
SAC 800	DV - 50
SAC 1000	DV - 80
SAC 1500	DV - 150
SAC 2000	DV - 150
SAC 3000	DV - 300
SAC 5000	n°2 pcs DV - 200

Sized using the following parameters: T. accumulation= 85 °C / T. inlet = 15 °C / Pre-charge pressure = 3 bar / Max pressure = 6 bar
The recommended capacity must be verified on the basis of the actual dimensions of the system implemented.

MODEL	MAGNESIUM ANODE SUPPLIED	CATHODIC PROTECTION APPLICABLE
SAC 300	1.1/4" x 320 / Cod. 8560040	Cathodic protection for cylinders 100/400 l. Code 8560170
SAC 500	1.1/4" x 410 / Cod. 8560050	Cathodic protection for cylinders 500/1000 l. Code 8560175
SAC 800	1.1/4" x 520 / Cod. 8560060	
SAC 1000	1.1/4" x 520 / Cod. 8560060	
SAC 1500	1.1/4" x 670 / Cod. 8560070	Cathodic protection for cylinders 1500/2000 l. Code 8560180
SAC 2000	1.1/4" x 670 / Cod. 8560070	Cathodic protection for cylinders 3000/5000 l. Code 8560185
SAC 3000	1.1/4" x 700 / Cod. 8560080	
SAC 5000	1.1/2" x 640 / Cod. 8560100	

TABLE OF HEATING ELEMENT APPLICABILITY TO CYLINDERS

Heating element model*					Water heating time from 15° C to 60° C (expressed in minutes) <i>The heating times outlined are approximate</i>							
CODE	Power (kW)	Voltage (Volt)	Connection	Length (mm)	SAC 300	SAC 500	SAC 800	SAC 1000	SAC 1500	SAC 2000	SAC 3000	SAC 5000
8601000	1	220 V / MF	G 1.1/4"	295	960 min.	1580 min.	2520 min.	3150 min.	4720 min.	6300 min.	9420 min.	15750 min.
8601650	1.65	220 V / MF	G 1.1/4"	450	580 min.	970 min.	1550 min.	1920 min.	2870 min.	3820 min.	5740 min.	9550 min.
8602000	2	220 V / MF	G 1.1/4"	515	480 min.	800 min.	1270 min.	1580 min.	2370 min.	3150 min.	4740 min.	7875 min.
8602600	2.6	220 V / MF	G 1.1/4"	675	n.a.	n.a.	980 min.	1230 min.	1810 min.	2450 min.	3660 min.	6125 min.
8602601	2.6	220 V / MF	G 1.1/4"	360	370 min.	630 min.	980 min.	1230 min.	1830 min.	2450 min.	3660 min.	6125 min.
8603300	3.3	220 V / MF	G 1.1/4"	825	n.a.	n.a.	n.a.	n.a.	1450 min.	1940 min.	2900 min.	4850 min.
8603301	3.3	220 V / MF	G 1.1/4"	435	295 min.	490 min.	780 min.	980 min.	1450 min.	1940 min.	2900 min.	4850 min.
8604001	4	220 V / MF	G 1.1/4"	510	240 min.	410 min.	640 min.	800 min.	1200 min.	1600 min.	2400 min.	4000 min.
8705000	5	380 V / TF	G 1.1/2"	445	200 min.	330 min.	520 min.	640 min.	950 min.	1300 min.	1900 min.	3250 min.
8706000	6	380 V / TF	G 1.1/2"	510	160 min.	280 min.	430 min.	540 min.	800 min.	1060 min.	1600 min.	2650 min.
8708000	8	380 V / TF	G 1.1/2"	670	n.a.	n.a.	330 min.	420 min.	610 min.	800 min.	1220 min.	2000 min.
8710000	10	380 V / TF	G 1.1/2"	820	n.a.	n.a.	n.a.	n.a.	490 min.	640 min.	980 min.	1600 min.
8712000	12	380 V / TF	G 1.1/2"	970	n.a.	n.a.	n.a.	n.a.	410 min.	540 min.	820 min.	1350 min.

n.a. =Heating element not applicable

SEE TABLE OF SYMBOLS
IN THE SHUTTER OF THE
COVER

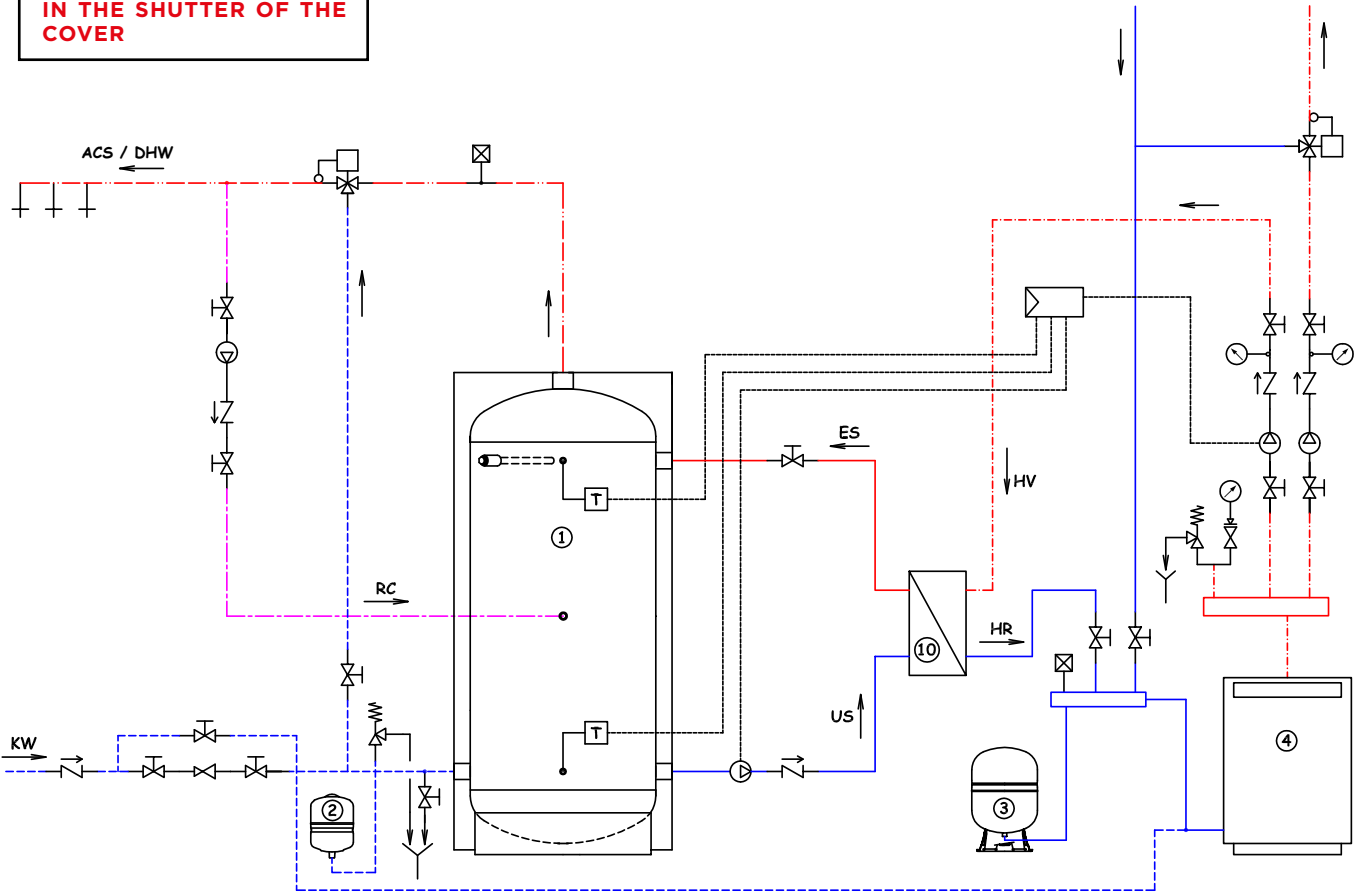

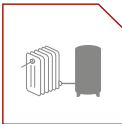

PUFFER

HEATED WATER BUFFER TANKS

FOR HEATING APPLICATIONS (300 - 5.000 LITRES)

PUFFER 300 - 500 - 800 - 1000

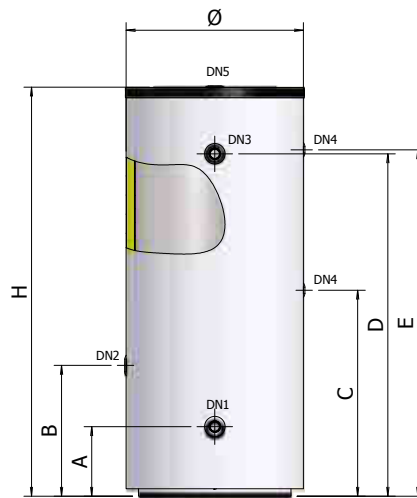
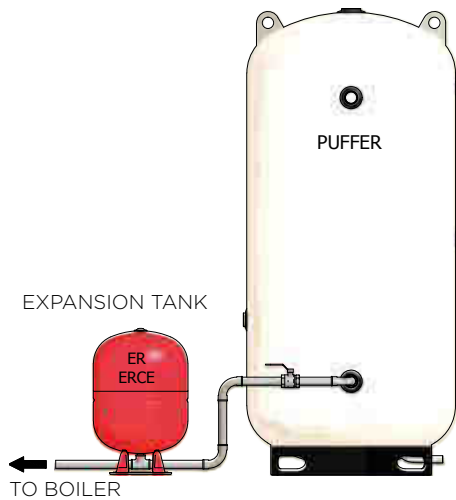

PUFFER 1500 - 5000

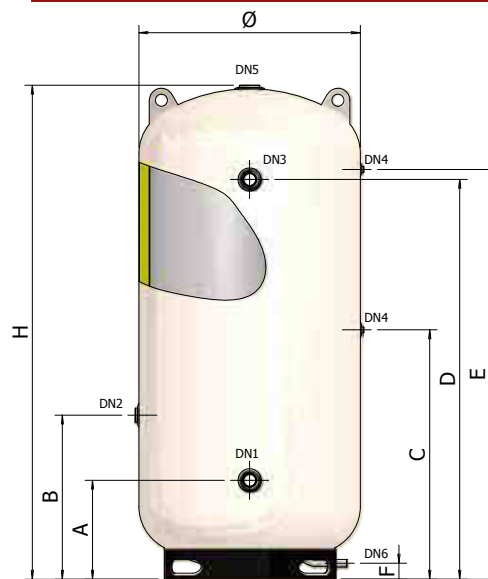

KEYWORD

DN1: To boiler; **DN2:** From plant (heating system); **DN3:** From boiler; **DN4:** Probes; **DN5:** To plant (heating system); **DN6:** Drain.

HOT WATER STORAGE TANK

+ 95°C
WORKING TEMPERATURE

HANDLING BY FORKLIFT

P_{MAX} 10 bar (300 - 1000)
MAX WORKING PRESSURE

FOR HEATING SYSTEMS

P_{MAX} 6 bar (1500 - 2000)
MAX WORKING PRESSURE

POLYURETHANE INSULATION

REFERENCE STANDARDS

ACCUMULATOR:

2014/68/UE Directive - ART. 4.3, without CE marking

WARRANTY: 2 YEARS



INSULATION:

Expanded polyurethane without CFC and HCFC up to 1000L
Expanded flexible polyurethane with open cells

INSTALLATION:

- traditional boilers (wall-hung and/or floor-standing)
- condensing boilers
- solar thermal systems

DIMENSIONS

MODEL	CODE	ENERGY LABEL				NOTES
		CL	LITRES	mm	mm	
PUFFER-300	A3GOL51 PGP40	C	300	650	1395	
PUFFER-500	A3GOL55 PGP40	D	500	750	1695	
PUFFER-800	A3GOL60 PGP40	/	800	900	1795	
PUFFER-1000	A3GOL62 PGP40	/	1000	900	2045	
PUFFER-1500	A3GOH67 P9016	/	1500	1100	2460	
PUFFER-2000	A3GOH70 P9016	/	2000	1200	2445	
PUFFER-3000	A3GOH74 GW050	/	3000	1350	2840	
PUFFER-5000	A3GOH80 GW050	/	5000	1700	3040	

MODEL	A mm	B mm	C mm	D mm	E mm	F mm
PUFFER-300	270	455	705	1140	1155	/
PUFFER-500	295	545	855	1415	1430	/
PUFFER-800	350	595	905	1460	1480	/
PUFFER-1000	350	655	1030	1710	1730	/
PUFFER-1500	495	820	1245	1995	2045	80
PUFFER-2000	485	810	1235	1985	2035	80
PUFFER-3000	530	930	1430	2330	2380	80
PUFFER-5000	635	1035	1535	2480	2485	80

MODEL	DN1	DN2	DN3	DN4	DN5	DN6
PUFFER-300	1.1/4"	1.1/4"	1.1/4"	1/2"	1.1/4"	/
PUFFER-500	1.1/4"	1.1/4"	1.1/4"	1/2"	1.1/4"	/
PUFFER-800	1.1/2"	1.1/2"	1.1/2"	1/2"	1.1/2"	/
PUFFER-1000	1.1/2"	1.1/2"	1.1/2"	1/2"	1.1/2"	/
PUFFER-1500	2"	2"	2"	1/2"	3"	1"
PUFFER-2000	2"	2"	2"	1/2"	3"	1"
PUFFER-3000	2"	2"	2"	1/2"	3"	1"
PUFFER-5000	2"	2"	2"	1/2"	3"	1"

TECHNICAL CHARACTERISTICS

MODEL	MAX WORKING PRESSURE	MAXIMUM WORKING TEMPERATURE
PUFFER 300	10 bar	95 °C
PUFFER 500		
PUFFER 800		
PUFFER 1000		
PUFFER 1500	6 bar	
PUFFER 2000		
PUFFER 3000		
PUFFER 5000		

MODEL	INSULATION TYPE	INSULATION THICKNESS	INSULATION DENSITY	INITIAL THERMAL CONDUCTIVITY	(*) INSULATION THERMAL LOSS	EXTERNAL COVER
PUFFER 300	95% closed cells rigid expanded polyurethane, CFC - HCFC free	50 mm	40 kg/m ³	23,5 mW/m K	2,208 kWh / 24h	Grey polystyrene RAL 9006
PUFFER 500					3,192 kWh / 24h	
PUFFER 800					3,958 kWh / 24h	
PUFFER 1000					4,449 kWh / 24h	
PUFFER 1500	Open cells flexible expanded polyurethane	50 mm	15 kg/m ³	39,0 mW/m K	9,969 kWh / 24h	Skay white RAL 9001
PUFFER 2000					10,856 kWh / 24h	
PUFFER 3000					13,799 kWh / 24h	
PUFFER 5000					18,264 kWh / 24h	

(*) Thermal loss calculated with an accumulation temperature equal to 65 °C and with an external temperature equal to 20 °C.

SEE TABLE OF SYMBOLS
IN THE SHUTTER OF THE
COVER

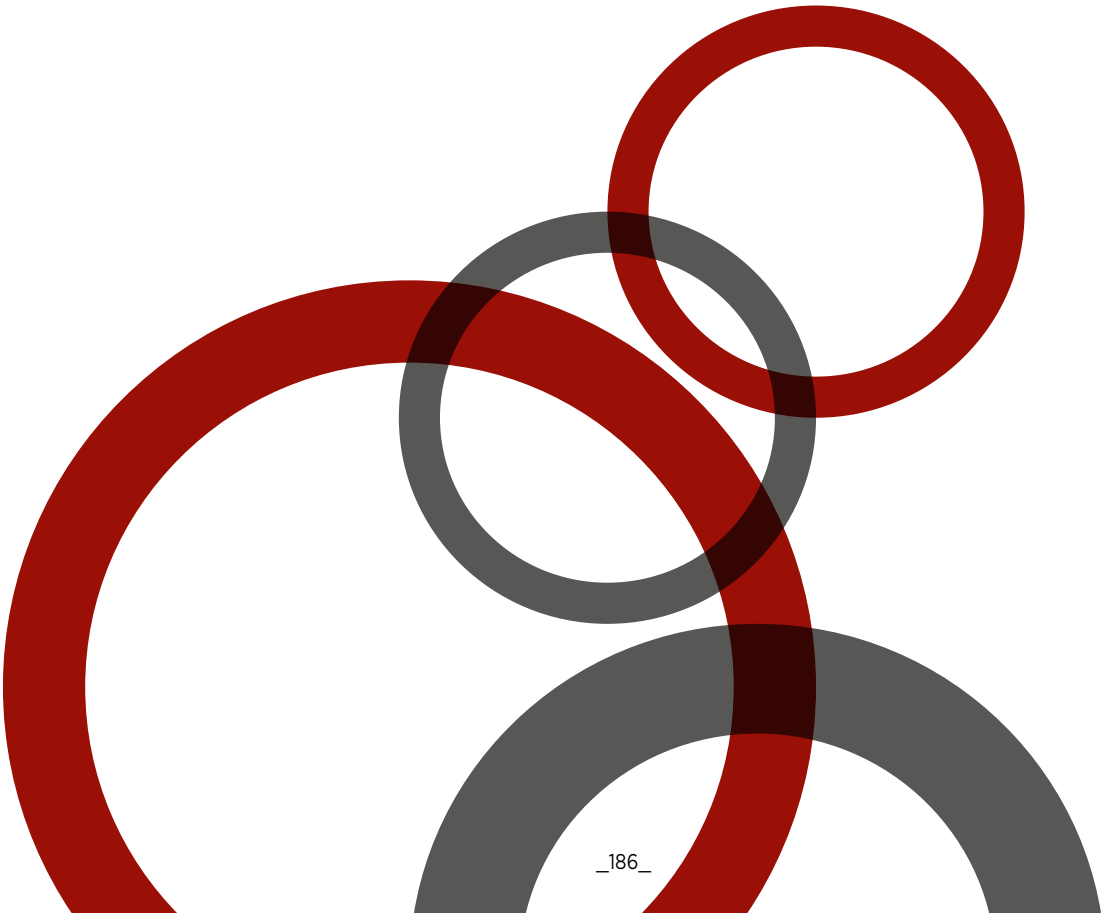
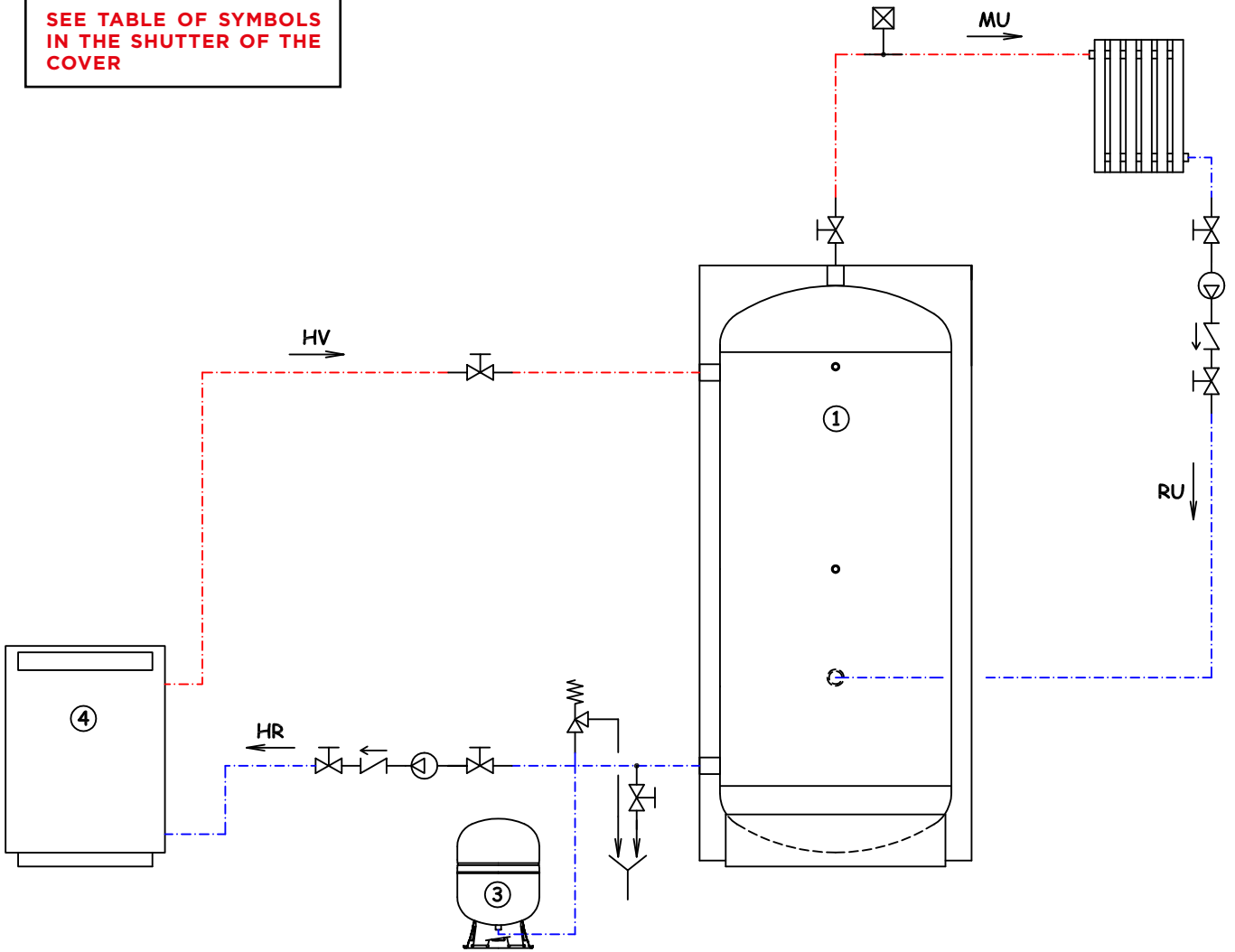



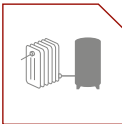

PUFFER PLUS

HEATED WATER BUFFER TANKS

FOR HEATING APPLICATIONS WITH MULTIPLE CONNECTIONS (100 - 5.000 LITRES)



PUFFER PLUS 1500 - 5000

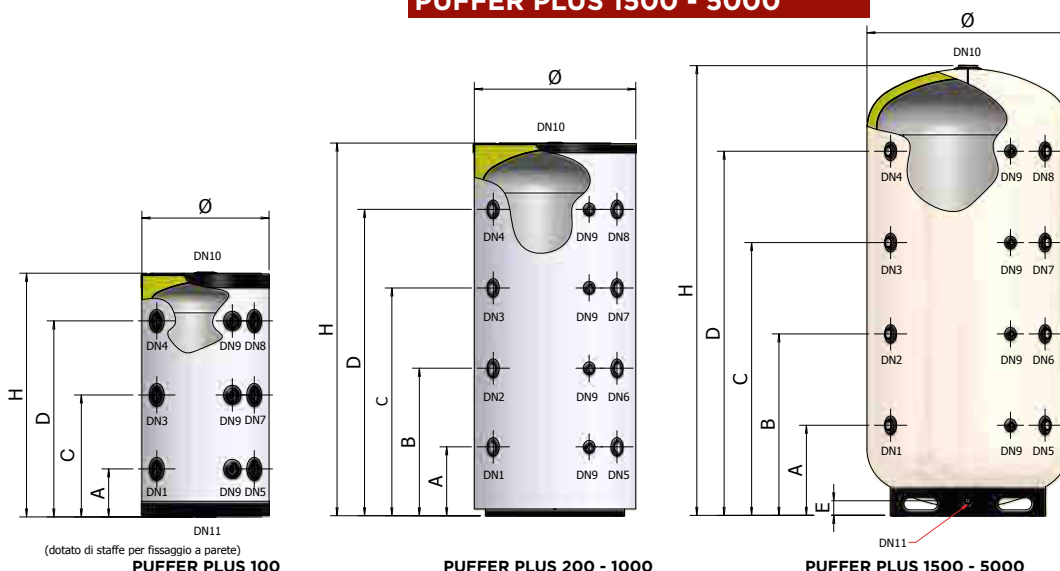

KEYWORD

DN1: To boiler; **DN2:** Auxiliary connection; **DN3:** To floor plant; **DN4:** From boiler; **DN5:** From floor plant; **DN6:** Auxiliary connection; **DN7:** From plant (heating system); **DN8:** To plant; **DN9:** Probes; **DN10:** Auxiliary connection; **DN11:** Drain.

HOT WATER STORAGE TANK

HANDLING BY FORKLIFT

FOR HEATING SYSTEMS

POLYURETHANE INSULATION

+ 95°C WORKING TEMPERATURE

P_{MAX} 10 bar (100 - 1000) MAX WORKING PRESSURE

P_{MAX} 6 bar (1500 - 2000) MAX WORKING PRESSURE

REFERENCE STANDARDS

ACCUMULATOR:

2014/68/UE Directive - ART. 4.3, without CE marking

WARRANTY: 2 YEARS

INSULATION:

Expanded polyurethane without CFC and HCFC up to 1000L
Expanded flexible polyurethane with open cells

INSTALLATION:

- traditional boilers (wall-hung and/or floor-standing)
- condensing boilers
- solar thermal systems

DIMENSIONS

MODEL	CODE	ENERGY LABEL	LITRES	mm	mm	DN1/* DN8	DN9	DN10	DN11	NOTES
		CL								
PUFFER PLUS-100	A3H0L38 PGP30	C	100	460	885	1"	1/2"	1,1/4"	1,1/4"	
PUFFER PLUS-200	A3H0L47 PGP40	C	200	600	1160	1,1/2"	1/2"	1,1/4"	/	
PUFFER PLUS-300	A3H0L51 PGP40	C	300	650	1395	1,1/2"	1/2"	1,1/4"	/	
PUFFER PLUS-500	A3H0L55 PGP40	D	500	750	1695	1,1/2"	1/2"	1,1/4"	/	
PUFFER PLUS-500	A3H0L60 PGP40	/	800	900	1795	1,1/2"	1/2"	1,1/2"	/	
PUFFER PLUS-1000	A3H0L62 PGP40	/	1000	900	2045	1,1/2"	1/2"	1,1/2"	/	
PUFFER PLUS-1500	A3H0H67 P9016	/	1500	1100	2460	1,1/2"	1/2"	3"	1"	
PUFFER PLUS-2000	A3H0H70 P9016	/	2000	1200	2445	1,1/2"	1/2"	3"	1"	
PUFFER PLUS-3000	A3H0H74 GW050	/	3000	1350	2840	1,1/2"	1/2"	3"	1"	
PUFFER PLUS-5000	A3H0H80 GW050	/	5000	1700	3040	1,1/2"	1/2"	3"	1"	

*DN2 and DN6 only for models from 300 to 5000 litres

MODEL	A mm	B mm	C mm	D mm	E mm
PUFFER PLUS-100	170	/	440	710	/
PUFFER PLUS-200	250	/	590	930	/
PUFFER PLUS-300	265	560	860	1150	/
PUFFER PLUS-500	290	665	1045	1420	/
PUFFER PLUS-800	380	730	1080	1430	/
PUFFER PLUS-1000	380	810	1250	1680	/
PUFFER PLUS-1500	495	995	1495	1995	80
PUFFER PLUS-2000	485	985	1485	1985	80
PUFFER PLUS-3000	530	930	1430	2330	80
PUFFER PLUS-5000	635	1235	1835	2435	80

TECHNICAL CHARACTERISTICS

MODEL	MAX WORKING PRESSURE	MAXIMUM WORKING TEMPERATURE
PUFFER PLUS 100	10 bar	95 °C
PUFFER PLUS 200		
PUFFER PLUS 300		
PUFFER PLUS 500		
PUFFER PLUS 800		
PUFFER PLUS 1000		
PUFFER PLUS 1500	6 bar	
PUFFER PLUS 2000		
PUFFER PLUS-3000		
PUFFER PLUS-5000		

MODEL	INSULATION TYPE	INSULATION THICKNESS	INSULATION DENSITY	INITIAL THERMAL CONDUCTIVITY	(*) INSULATION THERMAL LOSS	EXTERNAL FINISH
PUFFER PLUS 100	95% closed cells rigid expanded polyurethane, CFC - HCFC free	30 mm	40 kg/m ³	23,5 mW/m K	1,512 kWh / 24h	Grey polystyrene RAL 9006
PUFFER PLUS 200		50 mm			1,992 kWh / 24h	
PUFFER PLUS 300					2,208 kWh / 24h	
PUFFER PLUS 500					3,192 kWh / 24h	
PUFFER PLUS 800					3,958 kWh / 24h	
PUFFER PLUS 1000		4,449 kWh / 24h				
PUFFER PLUS 1500	Open cells flexible expanded polyurethane	50 mm	15 kg/m ³	39,0 mW/m K	9,969 kWh / 24h	Skay white RAL 9001
PUFFER PLUS 2000					10,865 kWh / 24h	
PUFFER PLUS 3000					13,799 kWh / 24h	
PUFFER PLUS 5000					18,264 kWh / 24h	

(*) Thermal loss calculated with an accumulation temperature equal to 60 °C and with an external temperature equal to 15 °C.

TABLE OF HEATING ELEMENT APPLICABILITY TO CYLINDERS

Heating element model*					Water heating time from 15° C to 60° C (expressed in minutes) <i>The heating times outlined are approximate</i>									
CODE	Power (kW)	Voltage (Volt)	Connection	Length (mm)	PUFFER PLUS 100	PUFFER PLUS 200	PUFFER PLUS 300	PUFFER PLUS 500	PUFFER PLUS 800	PUFFER PLUS 1000	PUFFER PLUS 1500	PUFFER PLUS 2000	PUFFER PLUS 3000	PUFFER PLUS 5000
8601000	1	220 V / MF	G 1.1/4"	295	320 min.	630 min.	960 min.	1580 min.	2520 min.	3150 min.	4720 min.	6300 min.	9420 min.	15750 min.
8601650	1.65	220 V / MF	G 1.1/4"	450	200 min.	380 min.	580 min.	970 min.	1550 min.	1920 min.	2870 min.	3820 min.	5740 min.	9550 min.
8602000	2	220 V / MF	G 1.1/4"	515	165 min.	315 min.	n.a.	800 min.	1270 min.	1580 min.	2370 min.	3150 min.	4740 min.	7875 min.
8602600	2.6	220 V / MF	G 1.1/4"	675	n.a.	242 min.	n.a.	n.a.	980 min.	1230 min.	1830 min.	2450 min.	3660 min.	6125 min.
8602601	2.6	220 V / MF	G 1.1/4"	360	130 min.	242 min.	370 min.	630 min.	980 min.	1230 min.	1830 min.	2450 min.	3660 min.	6125 min.
8603300	3.3	220 V / MF	G 1.1/4"	825	n.a.	190 min.	n.a.	n.a.	n.a.	n.a.	1450 min.	1940 min.	2900 min.	4850 min.
8603301	3.3	220 V / MF	G 1.1/4"	435	100 min.	190 min.	295 min.	490 min.	780 min.	980 min.	1450 min.	1940 min.	2900 min.	4850 min.
8604001	4	220 V / MF	G 1.1/4"	510	85 min.	157 min.	n.a.	410 min.	640 min.	800 min.	1200 min.	1600 min.	2400 min.	4000 min.
8705000	5	380 V / TF	G 1.1/2"	445	n.a.	n.a.	200 min.	330 min.	520 min.	640 min.	950 min.	1300 min.	1900 min.	3250 min.
8706000	6	380 V / TF	G 1.1/2"	510	n.a.	n.a.	n.a.	280 min.	430 min.	540 min.	800 min.	1060 min.	1600 min.	2650 min.
8708000	8	380 V / TF	G 1.1/2"	670	n.a.	n.a.	n.a.	n.a.	330 min.	420 min.	610 min.	800 min.	1220 min.	2000 min.
8710000	10	380 V / TF	G 1.1/2"	820	n.a.	n.a.	n.a.	n.a.	n.a.	n.a.	490 min.	640 min.	980 min.	1600 min.
8712000	12	380 V / TF	G 1.1/2"	970	n.a.	n.a.	n.a.	n.a.	n.a.	n.a.	410 min.	540 min.	820 min.	1350 min.

n.a. = Heating element not applicable

HYDRAULIC DIAGRAM

**SEE TABLE OF SYMBOLS
IN THE SHUTTER OF THE
COVER**

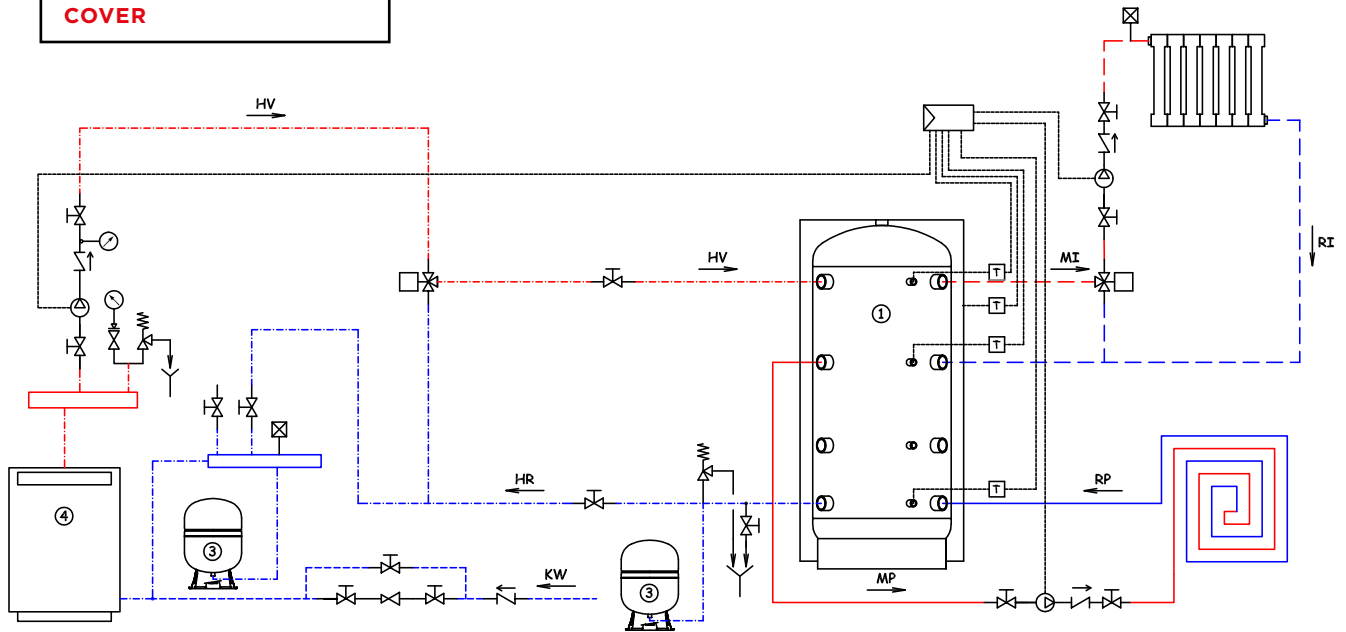



ACP

INERTIAL ACCUMULATORS FOR HEAT PUMPS

WALL MOUNTING (35 - 50 LITRES)

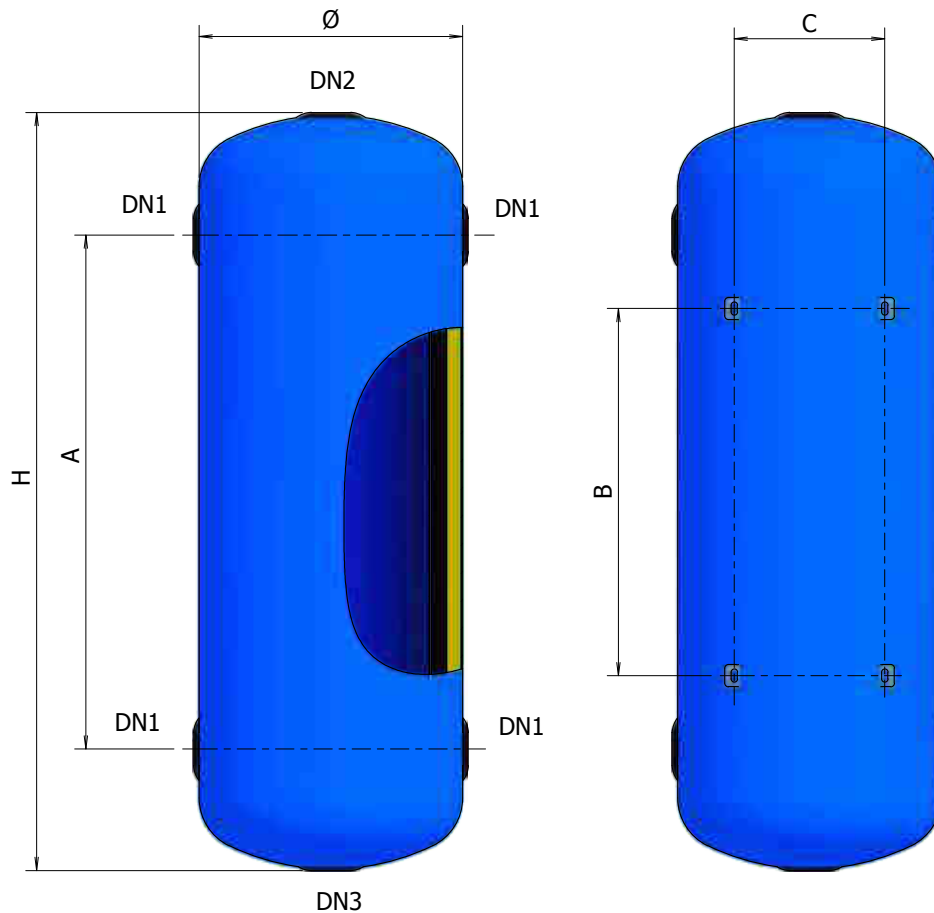

FOR CHILLED WATER



NOT FOR DRINKING WATER



FOR AIR CONDITIONING SYSTEMS



FOR HEATING SYSTEMS



HOT WATER STORAGE TANK



POLYURETHANE INSULATION



FOR HEATING PUMPS

CHARACTERISTICS:

- Min./max. working temperature: -10° / +95°C
 - Equipped with brackets for wall mounting
 - Internal, anti-corrosive teflon treatment.
- Internal, anti-corrosive teflon treatment ensures protection against corrosion of the inner surface of the accumulators

REFERENCE STANDARDS

- Complies with Art. 4.3 of the 2014/68/UE Directive without CE marking.

INSTALLATION:

- Use as a thermal flywheel in air conditioning / heating systems to optimise thermal inertia and increase the volume of chilled / hot water.
- Reduce the number of start-ups of the heat pump.

WARRANTY: 5 YEARS

INSULATION:

Closed cell cross-linked polyethylene and open cells flexible expanded polyurethane.

DIMENSIONS

MODEL	CODE	ENERGY LABEL	LITRES	mm	mm	A	B	C	DN1	DN2	DN3	NOTES
		CL										
ACP 35	A460L31	C	35	353	735	145	300	310	1"	1 1/4"	1 1/4"	
ACP 50	A460L34	C	50	353	1035	175	400	370	1"	1 1/4"	1 1/4"	

TECHNICAL CHARACTERISTICS

MODEL	MAX WORKING PRESSURE bar	MAXIMUM WORKING TEMPERATURE
ACP 35	10 bar	95 °C
ACP 50		

MODEL	INSULATION TYPE	INSULATION THICKNESS	INSULATION DENSITY	INITIAL THERMAL CONDUCTIVITY	EXTERNAL COVER
ACP 35	Closed cell cross-linked polyethylene and open cells flexible expanded polyurethane	20 mm and 20 mm	30 kg/m ³ and 15 kg/m ³	37mW/m K	Skay blu RAL 9006
ACP 50				39mW/m K	

The ACP accumulators are designed to be installed as a thermal flywheel in air conditioning / heating systems in order to optimize the overall thermal inertia by increasing the volume of water processed.

The additional accumulation also enables less frequent start-ups of the heat pump.

They are equipped with brackets for wall mounting.

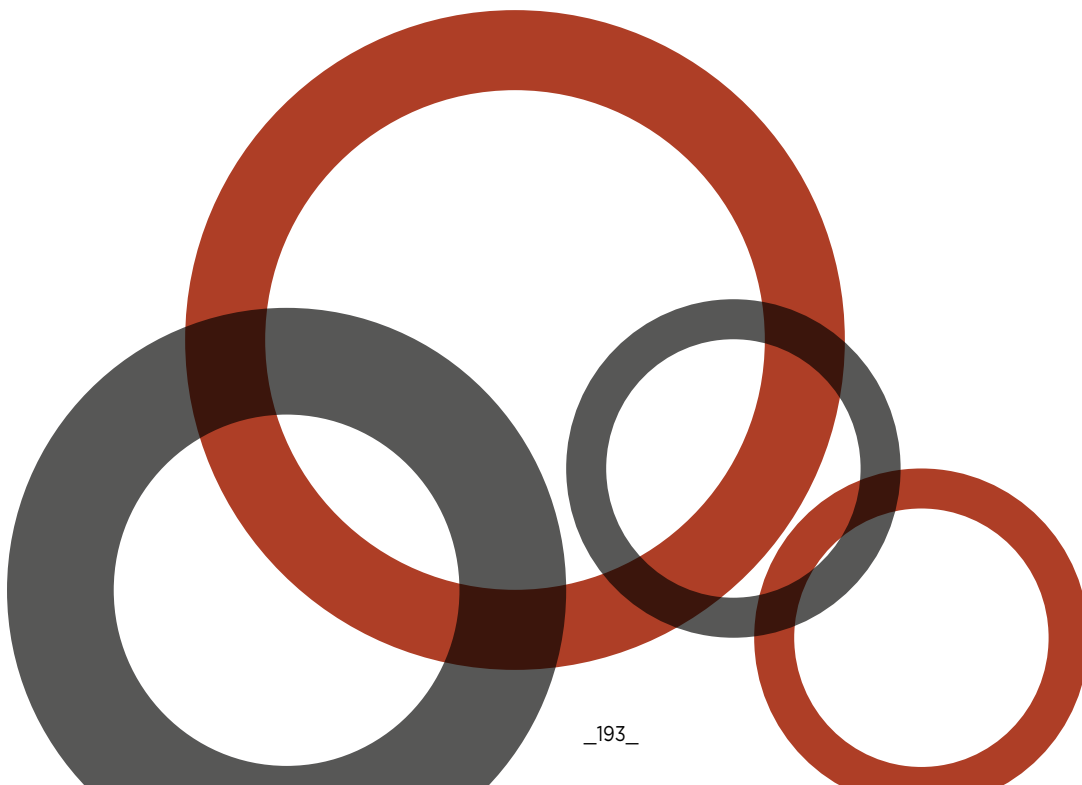

ACF

THERMAL FLYWHEEL FOR AIR CONDITIONING/ HEATING SYSTEMS

(100 - 5.000 LITRES)



ACF 100÷1000

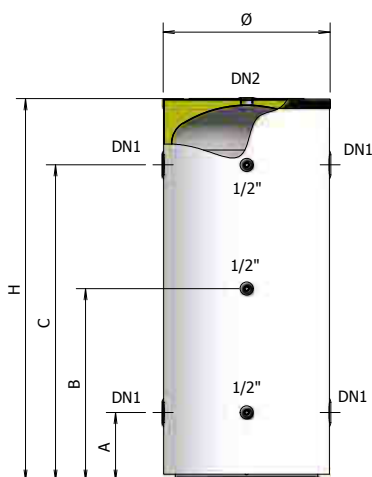

ACF 1500÷5000

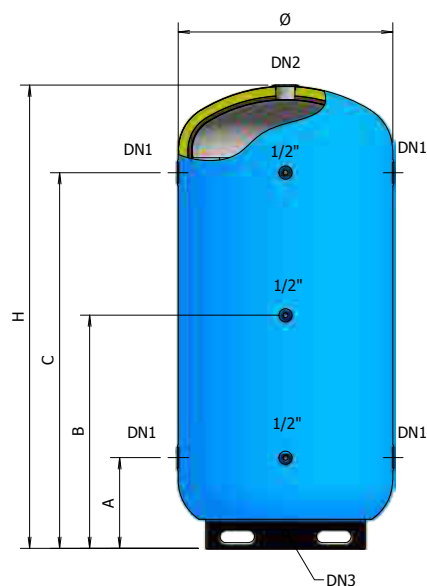

HOT WATER STORAGE TANK

FOR CHILLED WATER

NOT FOR DRINKING WATER

FOR AIR CONDITIONING SYSTEMS

FOR HEATING SYSTEMS

POLYURETHANE INSULATION

HANDLING BY FORKLIFT

+ 95°C
WORKING TEMPERATURE

REFERENCE STANDARDS

TANKS:

- Complies with Art. 4.3 of the 2014/68/UE Directive without CE marking.

INSTALLATION:

- Use as a thermal flywheel in air conditioning / heating systems to optimise thermal inertia and increase the volume of chilled / hot water.

WARRANTY: 5 YEARS

INSULATION:

Expanded polyurethane without CFC and HCFC up to 1000L
1500-500 L. closed cell polyurethane and soft polyurethane.

DIMENSIONS

MODEL	CODE	ENERGY LABEL	P max	A	B	C	E	DN1	DN2	DN3	NOTES			
		CL										LITRES	bar	mm
ACF 100	A480L38 GG230	C	100	10	500	925	185	425	665	-	1"1/2	1"1/4	-	
ACF 200	A480L47 GG250	C	200	10	620	1180	260	590	920	-	1"1/2	1"1/4	-	
ACF 300	A480L51 GG250	C	300	10	670	1420	285	710	1135	-	2"	1"1/4	-	
ACF 500	A480L55 GG250	D	500	10	770	1715	320	855	1390	-	3"	1"1/4	-	
ACF 800	A480L60 GG250	/	800	10	920	1805	370	905	1440	-	3"	1"1/2	-	
ACF 1000	A480L62 GG250	/	1000	10	920	2055	370	1030	1690	-	3"	1"1/2	-	
ACF 1500	A480H67 GB370	/	1500	6	1060	2485	485	1245	2005	80	3"	3"	1"	
ACF 2000	A480H70 GB370	/	2000	6	1160	2465	475	1235	1995	80	3"	3"	1"	
ACF 3000	A480H74 GB370	/	3000	6	1310	2860	540	1430	2320	80	4"	3"	1"	
ACF 5000	A480H80 GB370	/	5000	6	1660	3065	645	1535	2425	80	4"	3"	1"	

The ACF accumulators are designed to be installed as a thermal flywheel in air conditioning / heating systems in order to optimize the overall thermal inertia by increasing the volume of water processed.

The additional accumulation also enables less frequent intervention on the cooling units (in air conditioning systems) and on the thermal groups (in heating systems), making them therefore easier on the motors and the equipment. The accumulators were built using quality sheet metal and are welded using automatic procedures that guarantee a high level of quality.

They are supplied with threaded connections suitable for their type of use.

GENERAL INSTRUCTIONS FOR THE CHOICE OF AN ACCUMULATOR

A practical and useful formula to determine the accumulation volume is as follows:

$$C = \frac{W \cdot 4}{60 \Delta T}$$

where:

C = is the necessary accumulator volume (litres)

W = is the power of the cooling unit (W)

ΔT = is the difference between the minimum and maximum working temperature (°C)

Another practical method, used to choose the accumulation volume, is to foresee the total volume (accumulator + system) proportional to the power according to the values outlined below:

- | | |
|---|---------------------------|
| 1) ON-OFF systems: | 24 litres per kW of power |
| 2) systems with two partialisation levels: | 12 litres per kW of power |
| 3) systems with four partialisation levels: | 6 litres per kW of power |

TECHNICAL CHARACTERISTICS

MODEL	TYPE OF INSULATION	THICKNESS OF INSULATION	DENSITY OF INSULATION	INITIAL THERMAL CONDUCTIVITY	(*) INSULATION THERMAL LOSS	EXTERNAL COVER
ACF 100	95% closed cells rigid expanded polyurethane, CFC - HCFC free	30 mm	40 kg/m ³	23,5 mW/m K	1,512 kWh / 24h	Grey polystyrene RAL 9006
ACF 200		50 mm			1,992 kWh / 24h	
ACF 300					2,208 kWh / 24h	
ACF 500					3,192 kWh / 24h	
ACF 800					3,958 kWh / 24h	
ACF 1000		4,449 kWh / 24h				
ACF 1500	EXTERNAL: Closed cell, cross-linked polyethylene INTERNAL: open cells flexible expanded polyurethane	EXTERNAL: 20 mm	EXTERNAL: 30 kg/m ³	EXTERNAL: 37 mW/m K	9,969 kWh / 24h	Skay blue RAL 5015
ACF 2000		INTERNAL: 50 mm	INTERNAL: 15 kg/m ³	INTERNAL: 39 mW/m K	10,865 kWh / 24h	
ACF 3000			13,799 kWh / 24h			
ACF 5000			18,264 kWh / 24h			

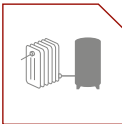

PPS1

BUFFER TANK FOR HEATING SYSTEMS

WITH FIXED SPIRAL COIL FOR HEATING APPLICATIONS (300 - 2.000 LITRES)

PPS1 300 - 500

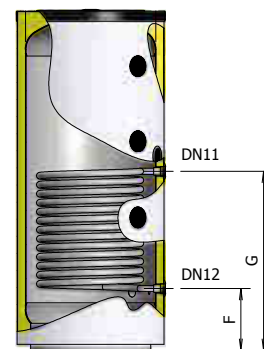
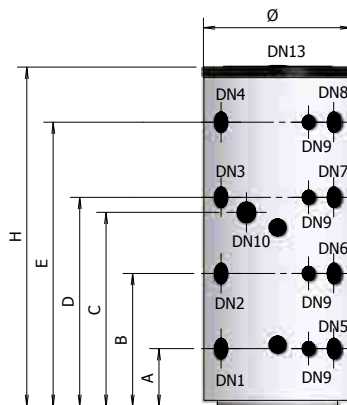
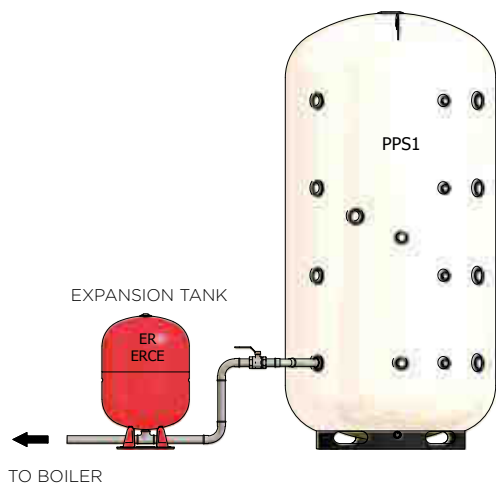

PPS1 800 - 1000 - 1500 - 2000

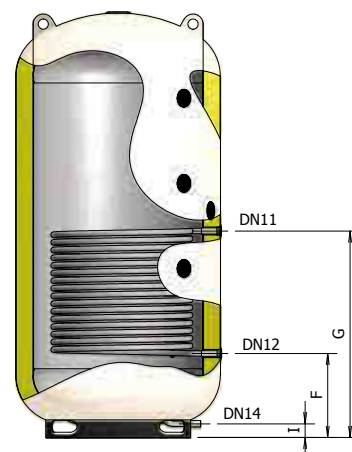
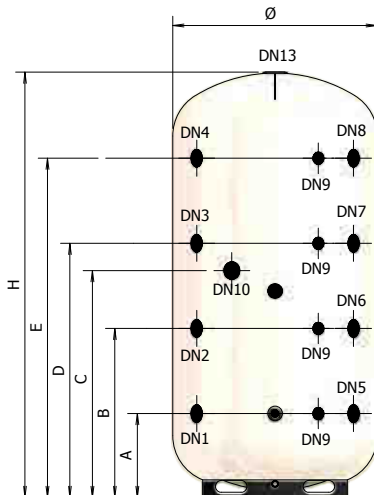

KEYWORD

DN1: from heating system; **DN2:** auxiliary connection; **DN3:** auxiliary connection; **DN4:** to heating system; **DN5:** from floor heating system; **DN6:** to biomass boiler; **DN7:** to floor heating system; **DN8:** from biomass boiler; **DN9:** probes; **DN10:** electric heating element; **DN11:** (solar) heat exchanger inlet; **DN12:** (solar) heat exchanger outlet; **DN13:** auxiliary connection; **DN14:** drain.

- HOT WATER STORAGE TANK
- HANDLING BY FORKLIFT
- FOR HEATING SYSTEMS
- POLYURETHANE INSULATION
- HOT WATER CYLINDER
- SUITABLE FOR SOLAR SYSTEMS

- + 95°C
CYLINDER MAX WORKING TEMPERATURE
- +110°C
HEAT EXCHANGER MAX TEMPERATURE
- P_{MAX}** 10 bar (300 - 1000)
6 bar (1500 - 2000)
MAX WORKING PRESSURE
- P_{SCA}** 12 bar
HEAT EXCHANGER MAX WORKING PRESSURE

WARRANTY: 2 YEARS

REFERENCE STANDARDS

ACCUMULATOR:

2014/68/UE Directive - ART. 4.3, without CE marking

INSULATION:

Expanded polyurethane without CFC and HCFC up to 100L
Expanded flexible polyurethane with open cells

INSTALLATION:

- traditional boilers (wall-hung and/or floor-standing)
- pellet boilers
- biomass boilers
- burning thermo-fireplaces
- solar heating systems

DIMENSIONS

MODEL	CODE	ENERGY LABEL	HEAT EXCHANGER							NOTES
			CL	LITRES	m ²	LITRES	mm	mm	DN 1	
PPSI-300	A3Z1L51 PGP40	C	300	1,5	9	650	1400	1"1/2	1"1/2	
PPSI-500	A3Z1L55 PGP40	D	500	2,1	14	750	1695	1"1/2	1"1/2	
PPSI-800	A3Z1L60 PGP40	/	800	2,4	16	900	1835	1"1/2	1"1/2	
PPSI-1000	A3Z1L62 PGP40	/	1000	3,0	20	900	2285	1"1/2	1"1/2	
PPSI-1500	A3Z1H67 P9016	/	1500	4,1	26	1100	2495	1"1/2	1"1/2	
PPSI-2000	A3Z1H70 P9016	/	2000	4,6	30	1200	2475	1"1/2	1"1/2	

MODEL	DN3	DN4	DN5	DN6	DN7	DN8	DN9	DN10	DN11	DN12
PPSI-300	1"1/2	1"1/2	1"1/2	1"1/2	1"1/2	1"1/2	1/2"	1"1/2	1"	1"
PPSI-500	1"1/2	1"1/2	1"1/2	1"1/2	1"1/2	1"1/2	1/2"	1"1/2	1"	1"
PPSI-800	1"1/2	1"1/2	1"1/2	1"1/2	1"1/2	1"1/2	1/2"	1"1/2	1"1/4	1"1/4
PPSI-1000	1"1/2	1"1/2	1"1/2	1"1/2	1"1/2	1"1/2	1/2"	1"1/2	1"1/4	1"1/4
PPSI-1500	1"1/2	1"1/2	1"1/2	1"1/2	1"1/2	1"1/2	1/2"	1"1/2	1"1/4	1"1/4
PPSI-2000	1"1/2	1"1/2	1"1/2	1"1/2	1"1/2	1"1/2	1/2"	1"1/2	1"1/4	1"1/4

MODEL	DN13	DN14	A	B	C	D	E	F	G	I
			mm	mm	mm	mm	mm	mm	mm	mm
PPSI-300	1"1/4	/	270	560	825	860	1150	285	780	/
PPSI-500	1"1/4	/	290	665	970	1045	1420	310	895	/
PPSI-800	1"1/2	/	380	730	960	1080	1430	380	875	/
PPSI-1000	1"1/2	/	380	810	1115	1250	1680	380	1040	/
PPSI-1500	3"	1"	495	995	1330	1495	1995	495	1155	80
PPSI-2000	3"	1"	485	985	1320	1485	1985	485	1160	80

TECHNICAL CHARACTERISTICS

MODEL	CYLINDER		HEAT EXCHANGER	
	MAX WORKING PRESSURE	MAX WORKING TEMPERATURE	MAX WORKING PRESSURE	MAX WORKING TEMPERATURE
PPSI-300	10 bar	95 °C	12 bar	110 °C
PPSI-500				
PPSI-800				
PPSI-1000				
PPSI-1500	6 bar			
PPSI-2000				

MODEL	INSULATION TYPE	INSULATION THICKNESS	INSULATION DENSITY	INITIAL THERMAL CONDUCTIVITY	(*) INSULATION THERMAL LOSS	EXTERNAL COVER
PPSI-300	95% closed cells rigid expanded polyurethane, CFC - HCFC free	50 mm	40 Kg/m ³	23,5 mW/m K	2,208 kW / 24h	Grey polystyrene RAL 9006
PPSI-500					3,192 kW / 24h	
PPSI-800					3,958 kW / 24h	
PPSI-1000					4,449 kW / 24h	
PPSI-1500	Open cells flexible expanded polyurethane		15 Kg/m ³	39 mW/m K	9,969 kW / 24h	White Sky RAL 9001
PPSI-2000					10,865 kW / 24h	

(*) Thermal loss calculated with an accumulation temperature equal to 65 °C and with an external temperature equal to 20 °C.

THERMAL YIELD WITH ACCUMULATION AT 65 °C

ACCUMULATION AT 65 °C

LOWER HEAT EXCHANGER: $T_{inlet} = 80^{\circ}\text{C}$; $\Delta T = 10^{\circ}\text{C}$

STORAGE TANK: $T_{inlet} = 55^{\circ}\text{C}$; $T_{accumulation} = 65^{\circ}\text{C}$

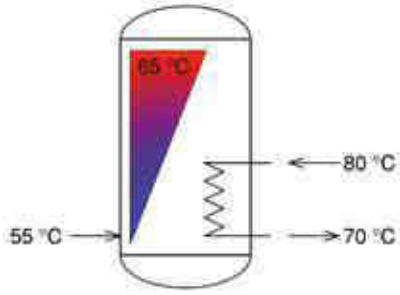

MODEL	HEAT EXCHANGER [m ²]	THERMAL POWER [kW]	PUMP CAPACITY [l/hour]
PPSI-300	1,5	13,1	1150
PPSI-500	2,1	18,3	1610
PPSI-800	2,4	21,0	1840
PPSI-1000	3,0	26,2	2300
PPSI-1500	4,1	35,8	3140
PPSI-2000	4,6	40,1	3520

HYDRAULIC DIAGRAM

SEE TABLE OF SYMBOLS IN THE SHUTTER OF THE COVER

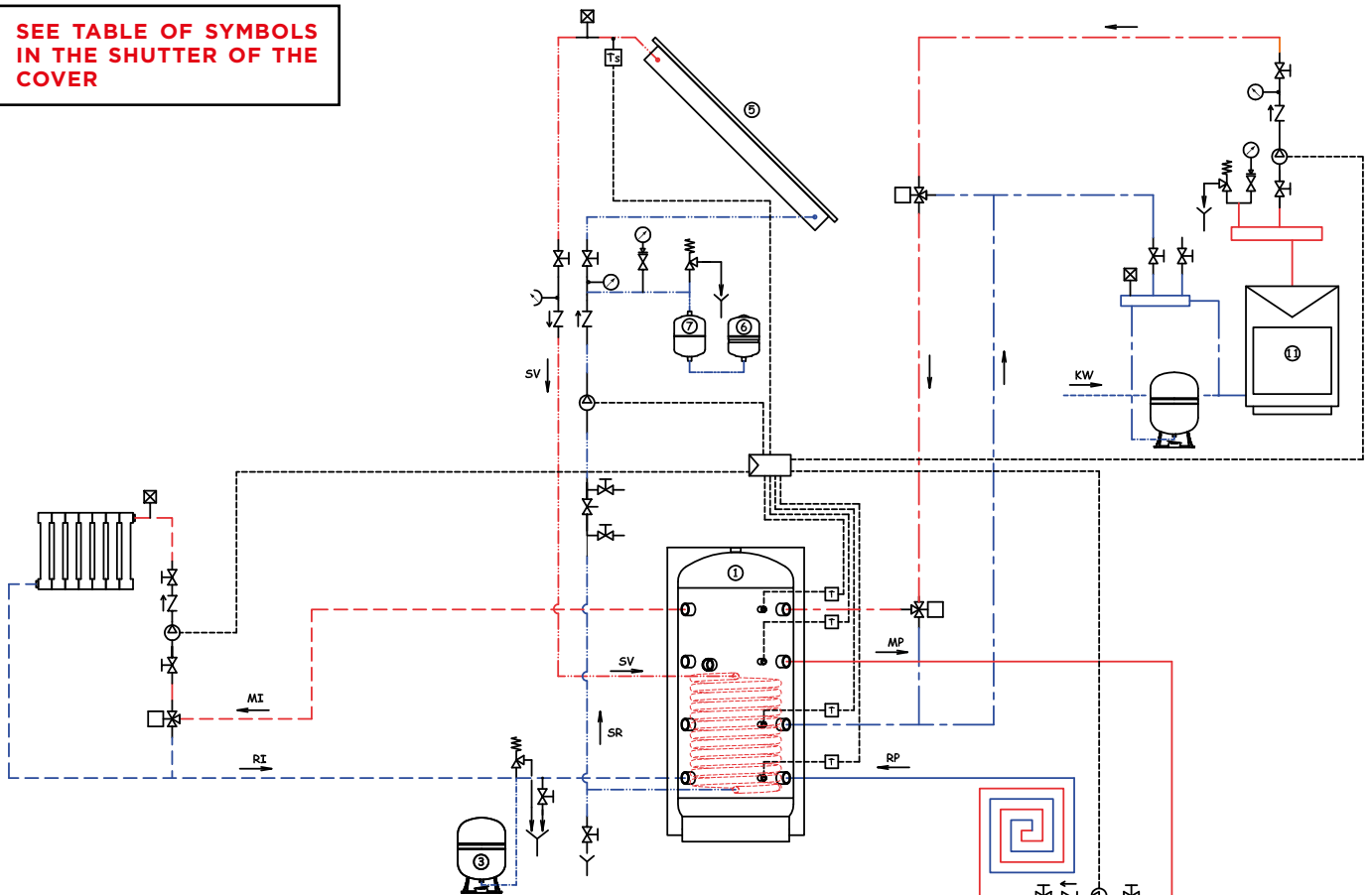



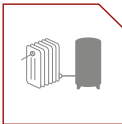

PPS2

BUFFER TANK FOR HEATING SYSTEMS

WITH TWO FIXED SPIRAL COILS FOR HEATING APPLICATIONS (300 - 2.000 LITRES)

PPS2 300 - 500

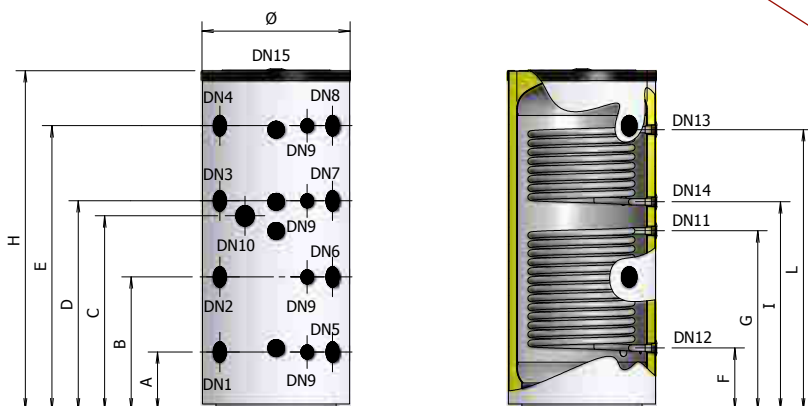
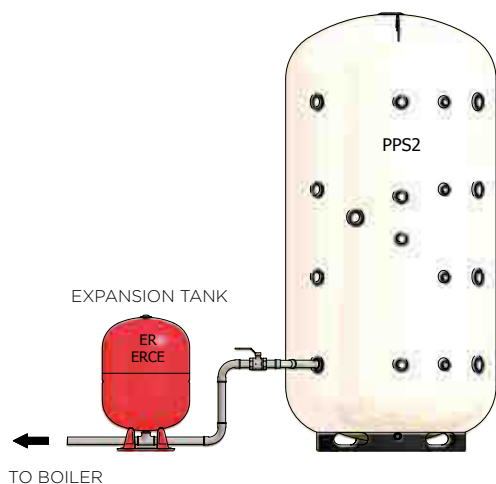

PPS2 800 - 1000 - 1500 - 2000

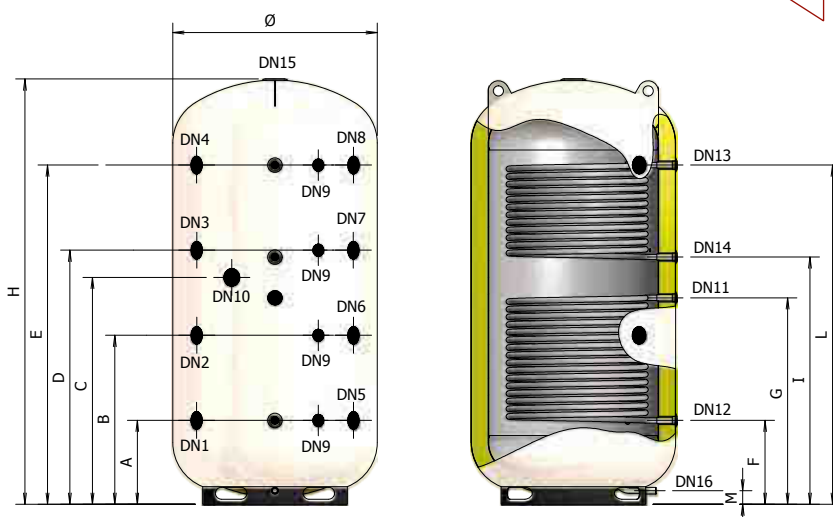

KEYWORD

DN1: from heating system; **DN2:** auxiliary connection; **DN3:** auxiliary connection; **DN4:** to heating system; **DN5:** from floor heating system; **DN6:** to biomass boiler; **DN7:** to floor heating system; **DN8:** from biomass boiler; **DN9:** probes; **DN10:** electric heating element; **DN11:** low solar heat exchanger inlet; **DN12:** low solar heat exchanger outlet; **DN13:** boiler heat exchanger inlet; **DN14:** boiler heat exchanger outlet; **DN15:** auxiliary connection; **DN16:** drain.

- HOT WATER STORAGE TANK
- HANDLING BY FORKLIFT
- FOR HEATING SYSTEMS
- POLYURETHANE INSULATION
- HOT WATER CYLINDER
- SUITABLE FOR SOLAR SYSTEMS

- + 95°C
CYLINDER MAX WORKING TEMPERATURE
- +110°C
HEAT EXCHANGER MAX TEMPERATURE
- P_{MAX}** 10 bar (300 - 1000)
6 bar (1500 - 2000)
MAX WORKING PRESSURE
- P_{SICA}** 12 bar
HEAT EXCHANGER MAX WORKING PRESSURE

WARRANTY: 2 YEARS

REFERENCE STANDARDS

ACCUMULATOR:

2014/68/UE Directive - ART. 4.3, without CE marking

INSULATION:

Expanded polyurethane without CFC and HCFC up to 1000L
Expanded flexible polyurethane with open cells

INSTALLATION:

- traditional boilers (wall-hung and/or floor-standing)
- pellet boilers
- biomass boilers
- burning thermo-fireplaces
- solar heating systems

DIMENSIONS

MODEL	CODE	ENERGY LABEL	HEAT EXCHANGER				HEAT EXCHANGER				DN 1	DN 2	NOTES
			LOWER		UPPER		mm	mm	mm	mm			
			CL	LITRES	m ²	LITRES							
PPS2-300	A3Z2L51 PGP40	C	300	1,5	9	0,8	5	650	1400	1"1/2	1"1/2		
PPS2-500	A3Z2L55 PGP40	D	500	2,1	14	1,3	8	750	1695	1"1/2	1"1/2		
PPS2-800	A3Z2L60 PGP40	/	800	2,4	16	1,8	10	900	1835	1"1/2	1"1/2		
PPS2-1000	A3Z2L62 PGP40	/	1000	3,0	20	2,4	15	900	2285	1"1/2	1"1/2		
PPS2-1500	A3Z2H67 P9016	/	1500	4,1	26	3,0	19	1100	2495	1"1/2	1"1/2		
PPS2-2000	A3Z2H70 P9016	/	2000	4,6	30	3,4	21	1200	2475	1"1/2	1"1/2		

MODEL	DN3	DN4	DN5	DN6	DN7	DN8	DN9	DN10	DN11	DN12	DN13	DN14
PPS2-300	1"1/2	1"1/2	1"1/2	1"1/2	1"1/2	1"1/2	1/2"	1"1/2	1"	1"	1"	1"
PPS2-500	1"1/2	1"1/2	1"1/2	1"1/2	1"1/2	1"1/2	1/2"	1"1/2	1"	1"	1"	1"
PPS2-800	1"1/2	1"1/2	1"1/2	1"1/2	1"1/2	1"1/2	1/2"	1"1/2	1"1/4	1"1/4	1"1/4	1"1/4
PPS2-1000	1"1/2	1"1/2	1"1/2	1"1/2	1"1/2	1"1/2	1/2"	1"1/2	1"1/4	1"1/4	1"1/4	1"1/4
PPS2-1500	1"1/2	1"1/2	1"1/2	1"1/2	1"1/2	1"1/2	1/2"	1"1/2	1"1/4	1"1/4	1"1/4	1"1/4
PPS2-2000	1"1/2	1"1/2	1"1/2	1"1/2	1"1/2	1"1/2	1/2"	1"1/2	1"1/4	1"1/4	1"1/4	1"1/4

MODEL	DN15	DN16	A	B	C	D	E	F	G	I	L	M
			mm	mm	mm	mm	mm	mm	mm	mm	mm	mm
PPS2-300	1"1/4	/	270	560	845	860	1150	285	780	870	1140	/
PPS2-500	1"1/4	/	290	665	970	1045	1420	310	895	1040	1400	/
PPS2-800	1"1/2	/	380	730	975	1080	1430	380	875	1070	1430	/
PPS2-1000	1"1/2	/	380	810	1100	1250	1680	380	1010	1185	1680	/
PPS2-1500	3"	1"	495	995	1335	1495	1995	495	1170	1500	1995	80
PPS2-2000	3"	1"	485	985	1325	1485	1985	485	1160	1490	1985	80

TECHNICAL CHARACTERISTICS

MODEL	CYLINDER		HEAT EXCHANGERS	
	MAX WORKING PRESSURE	MAX WORKING TEMPERATURE	MAX WORKING PRESSURE	MAX WORKING TEMPERATURE
PPS2-300	10 bar	95 °C	12 bar	110 °C
PPS2-500				
PPS2-800				
PPS2-1000				
PPS2-1500	6 bar			
PPS2-2000				

MODEL	INSULATION TYPE	INSULATION THICKNESS	INSULATION DENSITY	INITIAL THERMAL CONDUCTIVITY	(*) INSULATION THERMAL LOSS	EXTERNAL COVER
PPS2-300	95% closed cells rigid expanded polyurethane, CFC - HCFC free	50 mm	40 Kg/m ³	23,5 mW/m K	2,208 kW / 24h	Grey polystyrene RAL 9006
PPS2-500					3,192 kW / 24h	
PPS2-800					3,958 kW / 24h	
PPS2-1000					4,449 kW / 24h	
PPS2-1500	Open cells flexible expanded polyurethane		15 Kg/m ³	39 mW/m K	9,969 kW / 24h	White Sky RAL 9001
PPS2-2000					10,865 kW / 24h	

(*) Thermal loss calculated with an accumulation temperature equal to 65 °C and with an external temperature equal to 20 °C.

ACCUMULATION AT 65 °C

LOWER HEAT EXCHANGER: $T_{inlet} = 80^{\circ}\text{C}$; $\Delta T = 10^{\circ}\text{C}$

STORAGE TANK: $T_{inlet} = 55^{\circ}\text{C}$; $T_{accumulation} = 65^{\circ}\text{C}$

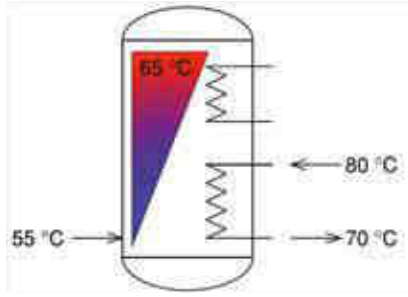

MODEL	HEAT EXCHANGER [m ²]	THERMAL POWER [kW]	PUMP CAPACITY [l/hour]
PPS2-300	1,5	13,1	1150
PPS2-500	2,1	18,3	1610
PPS2-800	2,4	21,0	1840
PPS2-1000	3,0	26,2	2300
PPS2-1500	4,1	35,8	3140
PPS2-2000	4,6	40,1	3520

ACCUMULATION AT 65 °C

UPPER HEAT EXCHANGER: $T_{inlet} = 80^{\circ}\text{C}$; $\Delta T = 10^{\circ}\text{C}$

STORAGE TANK: $T_{inlet} = 55^{\circ}\text{C}$; $T_{accumulation} = 65^{\circ}\text{C}$

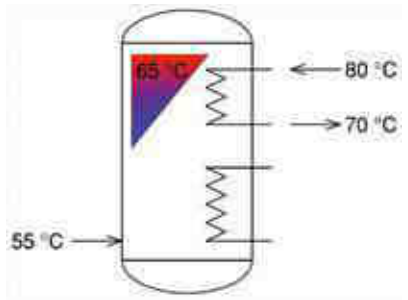

MODEL	HEAT EXCHANGER [m ²]	THERMAL POWER [kW]	PUMP CAPACITY [l/hour]
PPS2-300	0,8	7,0	610
PPS2-500	1,3	11,3	995
PPS2-800	1,8	15,7	1300
PPS2-1000	2,4	21,0	1840
PPS2-1500	3	26,2	2300
PPS2-2000	3,4	29,6	2600

SEE TABLE OF SYMBOLS
IN THE SHUTTER OF THE
COVER

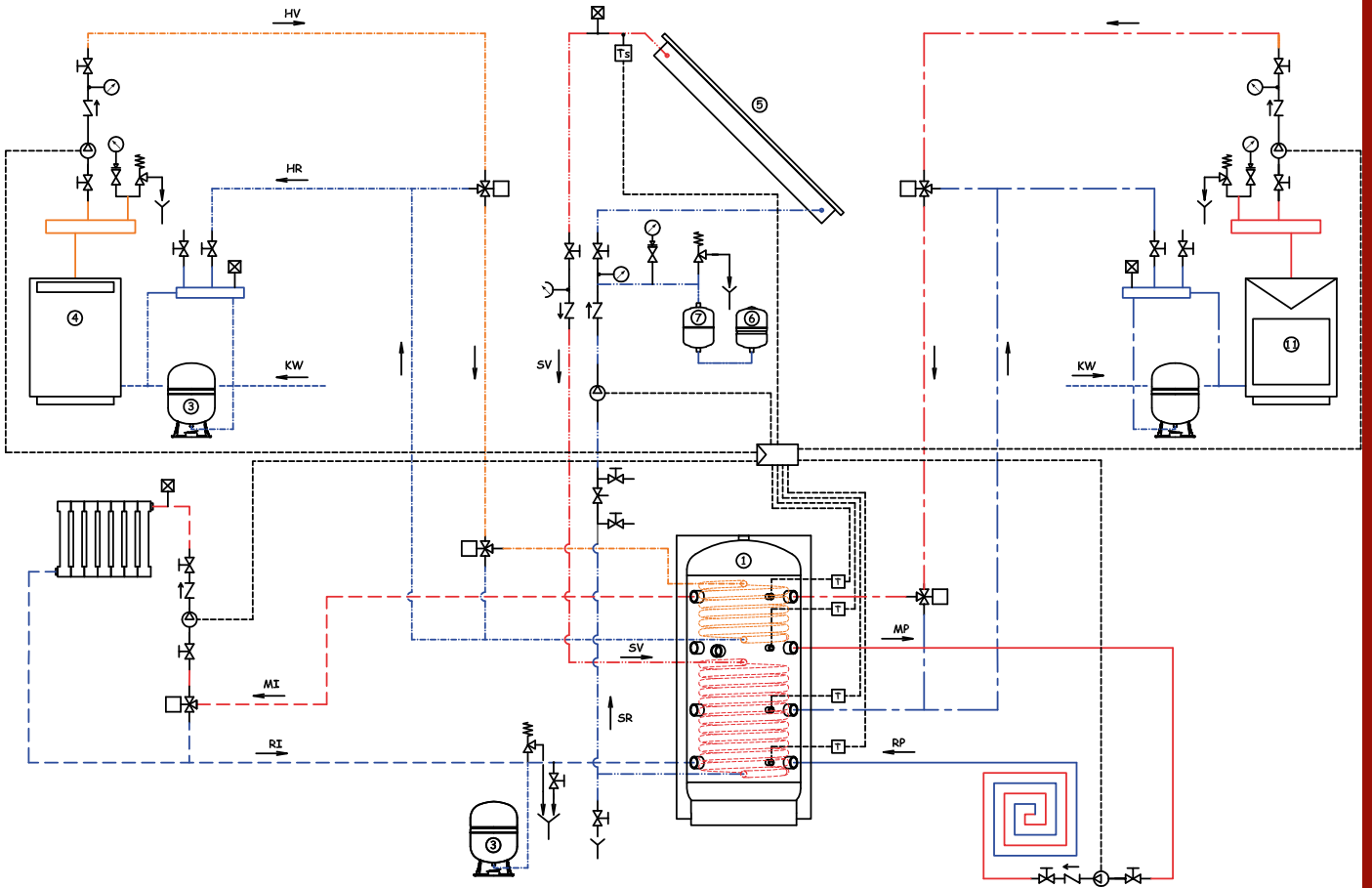



BSE

GLASSLINED ACCUMULATORS FOR SANITARY HOT WATER WITH PLATE HEAT EXCHANGERS

(300 - 2000 LITRES)

BSE 300 - 1000 litri

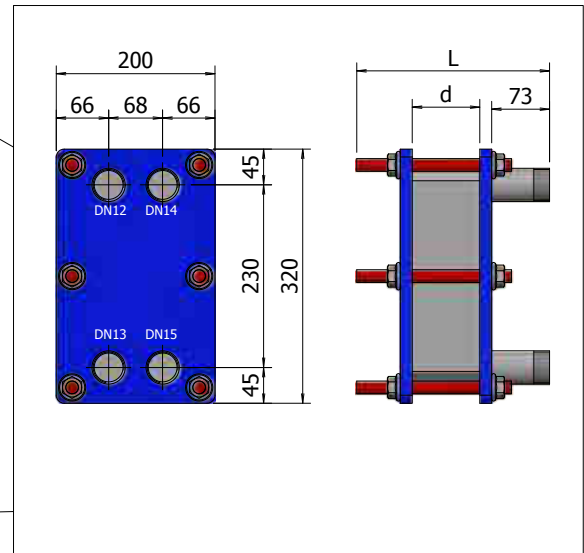
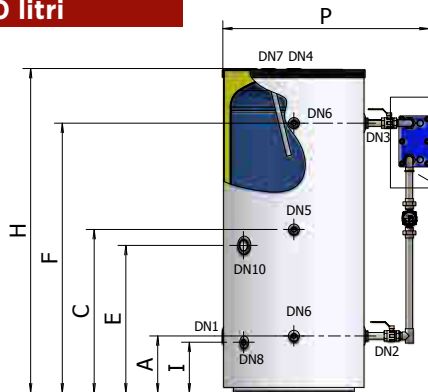

BSE 1.500 - 2000 litri

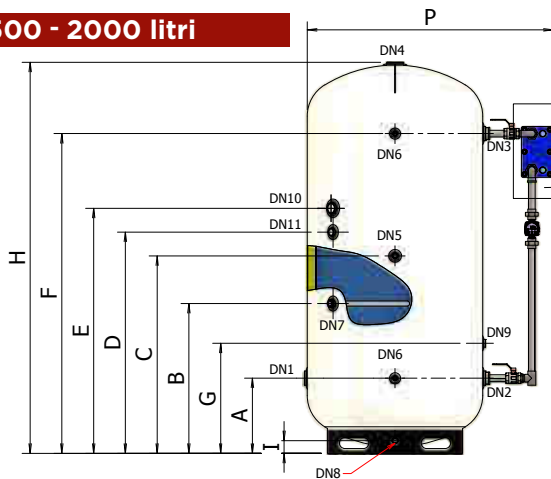

KEYWORD

DN1: Sanitary cold water inlet; **DN2:** Sanitary water inlet to plate heat exchangers; **DN3:** Sanitary hot water outlet from external heat exchanger; **DN4:** Sanitary hot water outlet; **DN5:** Recirculation; **DN6:** Probes; **DN7:** Magnesium anode; **DN8:** Drain; **DN9:** Sanitary expansion tank connection; **DN10:** Heating element; **DN11:** Predisposition for auxiliary magnesium anode; **DN12:** Secondary circuit exchanger inlet; **DN13:** Secondary circuit exchanger outlet; **DN14:** Primary circuit exchanger inlet; **DN15:** Primary circuit exchanger outlet.

FOR SANITARY HOT WATER

MAGNESIUM ANODE

HANDLING BY FORKLIFT

INTERNAL, ANTI-CORROSIVE
GLASSLINING PROCESS

POLYURETHANE INSULATION

+ 95°C
CYLINDER MAX WORKING
TEMPERATURE

+ 110°C
HEAT EXCHANGER
MAX TEMPERATURE

P_{MAX} 10 bar (300 - 1000)
6 bar (1500 - 2000)
MAX WORKING PRESSURE

P_{PCA} 10 bar
HEAT EXCHANGER
MAX WORKING PRESSURE

WARRANTY: 2 YEARS (HEAT EXCHANGERS
CIRCULATION UNIT)
5 YEARS (SAC)

INSULATION:

- Heat exchangers not insulated
- Cylinder, see SAC model

REFERENCE STANDARDS

ACCUMULATOR - HEAT EXCHANGER:

2014/68/UE Directive - ART. 4.3, without CE marking

THE KITS ARE EQUIPPED WITH:

- plate heat exchangers in stainless steel AISI 316 (see pag. 208 for details of the available exchanger models);
- recirculation pump (sanitary circuit);
- fitting connection between heat exchanger and accumulator.

INSTALLATION:

- traditional boilers(wall-hung and/or floor-standing)
- pellet boilers
- biomass boilers
- burning thermo-fireplaces
- solar heating systems

DIMENSIONS

MODEL	CODE	ACCUMULATOR MODEL	ENERGY LABEL	P	PLATE HEAT EXCHANGER	TIGHTENING MESURE(D)	L	NOTES
			CLASS		mm	NR		
BSE 300-09	A3IOL51 SBA09	SAC 300	C	1070	9	28	251	
BSE 300-13	A3IOL51 SBA13				13	39		
BSE 300-17	A3IOL51 SBA17				17	50		
BSE 300-21	A3IOL51 SBA21				21	61		
BSE 300-25	A3IOL51 SBA25				25	72		
BSE 300-29	A3IOL51 SBA29				29	84		
BSE 300-33	A3IOL51 SBA33				33	95	351	
BSE 500-09	A3IOL55 SBA09	SAC 500	D	1170	9	28	251	
BSE 500-13	A3IOL55 SBA13				13	39		
BSE 500-17	A3IOL55 SBA17				17	50		
BSE 500-21	A3IOL55 SBA21				21	61		
BSE 500-25	A3IOL55 SBA25				25	72		
BSE 500-29	A3IOL55 SBA29				29	84		
BSE 500-33	A3IOL55 SBA33				33	95	351	
BSE 800-09	A3IOL60 SBA09	SAC 800	/	1320	9	28	251	
BSE 800-13	A3IOL60 SBA13				13	39		
BSE 800-17	A3IOL60 SBA17				17	50		
BSE 800-21	A3IOL60 SBA21				21	61		
BSE 800-25	A3IOL60 SBA25				25	72		
BSE 800-29	A3IOL60 SBA29				29	84		
BSE 800-33	A3IOL60 SBA33				33	95	351	
BSE 1000-09	A3IOL62 SBA09	SAC 1000	/	1320	9	28	251	
BSE 1000-13	A3IOL62 SBA13				13	39		
BSE 1000-17	A3IOL62 SBA17				17	50		
BSE 1000-21	A3IOL62 SBA21				21	61		
BSE 1000-25	A3IOL62 SBA25				25	72		
BSE 1000-29	A3IOL62 SBA29				29	84		
BSE 1000-33	A3IOL62 SBA33				33	95	351	
BSE 1500-09	A3IOH67 SBA09	SAC 1500	/	1520	9	28	251	
BSE 1500-13	A3IOH67 SBA13				13	39		
BSE 1500-17	A3IOH67 SBA17				17	50		
BSE 1500-21	A3IOH67 SBA21				21	61		
BSE 1500-25	A3IOH67 SBA25				25	72		
BSE 1500-29	A3IOH67 SBA29				29	84		
BSE 1500-33	A3IOH67 SBA33				33	95	351	
BSE 2000-09	A3IOH70 SBA09	SAC 2000	/	1620	9	28	251	
BSE 2000-13	A3IOH70 SBA13				13	39		
BSE 2000-17	A3IOH70 SBA17				17	50		
BSE 2000-21	A3IOH70 SBA21				21	61		
BSE 2000-25	A3IOH70 SBA25				25	72		
BSE 2000-29	A3IOH70 SBA29				29	84		
BSE 2000-33	A3IOH70 SBA33				33	95	351	

For dimensional data and performance relative to SAC model, see pag. 180)

ACCUMULATION AT 45 °C

HEAT EXCHANGER: $T_{inlet} = 80^{\circ}C$; $\Delta T = 20^{\circ}C$

STORAGE TANK: $T_{inlet} = 15^{\circ}C$; $T_{accumulation} = 45^{\circ}C$

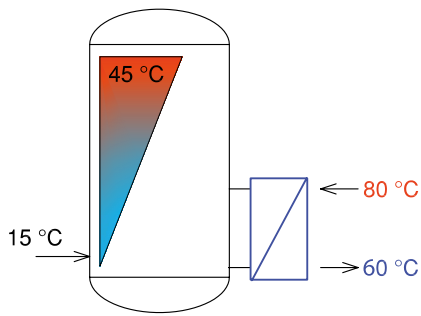

PLATE HEAT EXCHANGERS NR.	THERMAL POWER [kW]	PRIMARY		SECONDARY	
		CAPACITY [lt/h]	PRESSURE DROP m.c.a.	CAPACITY [lt/h]	PRESSURE DROP m.c.a.
9	47	2065	2,489	1355	1,096
13	70	3076	2,504	2019	1,103
17	92	4042	2,503	2653	1,102
21	114	5009	2,545	3288	1,120
25	145	6371	2,964	4182	1,304
29	166	7294	2,989	4787	1,315
33	185	8128	2,992	5335	1,316

ACCUMULATION AT 45 °C

HEAT EXCHANGER: $T_{inlet} = 65^{\circ}C$; $\Delta T = 20^{\circ}C$

STORAGE TANK: $T_{inlet} = 15^{\circ}C$; $T_{accumulation} = 45^{\circ}C$

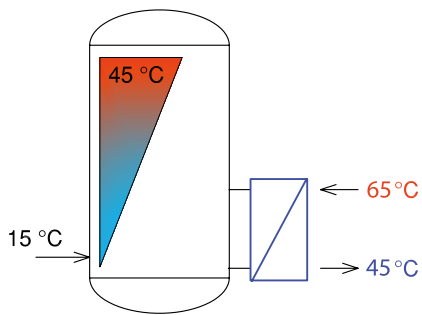
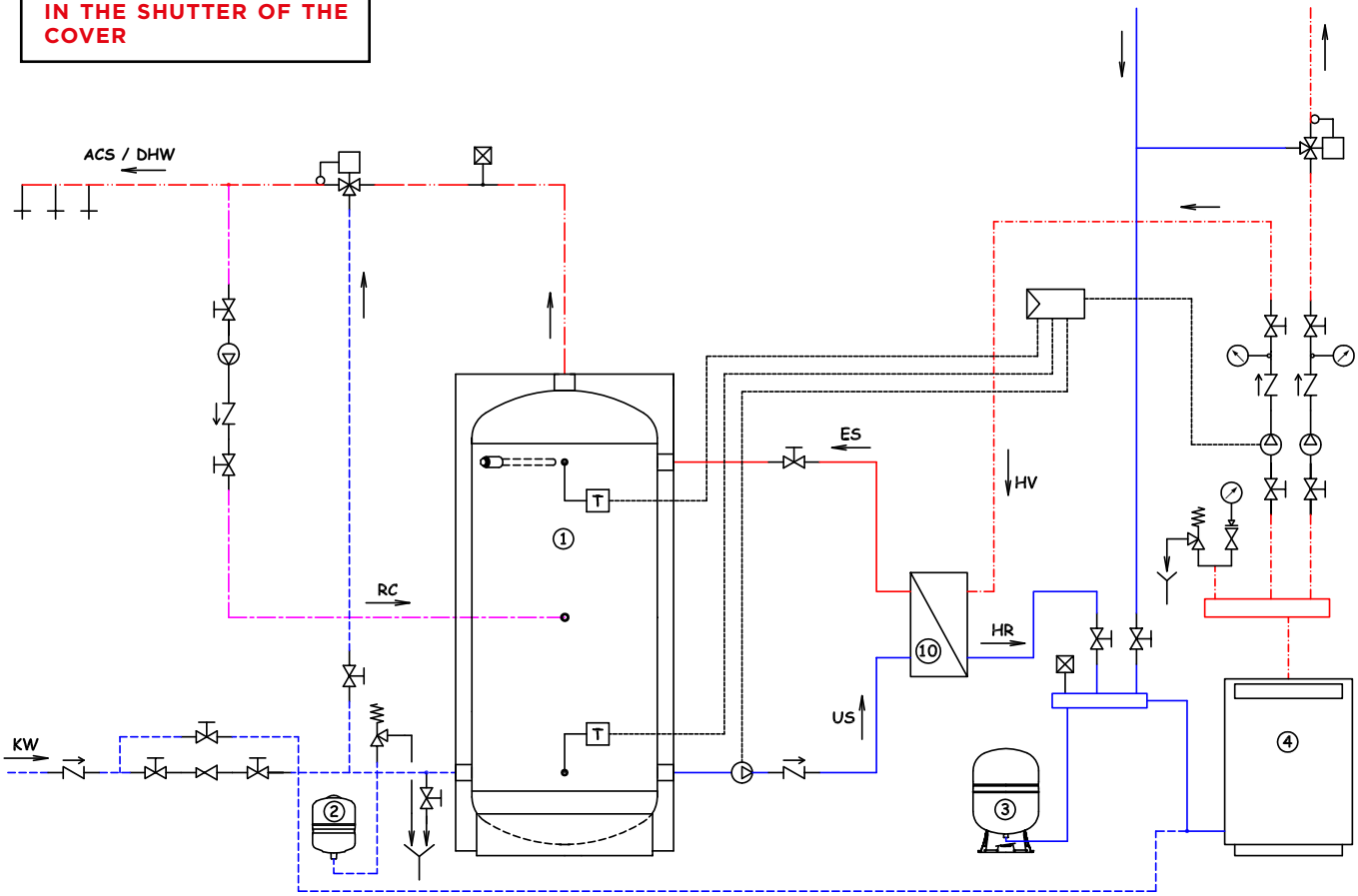

PLATE HEAT EXCHANGERS NR.	THERMAL POWER [kW]	PRIMARY		SECONDARY	
		CAPACITY [lt/h]	PRESSURE DROP m.c.a.	CAPACITY [lt/h]	PRESSURE DROP m.c.a.
9	19	830	0,441	548	0,200
13	32	1397	0,560	923	0,254
17	42	1834	0,557	1211	0,252
21	58	2532	0,696	1673	0,314
25	70	3056	0,731	2019	0,330
29	83	3624	0,786	2394	0,354
33	96	4191	0,844	2768	0,380

SEE TABLE OF SYMBOLS
IN THE SHUTTER OF THE
COVER



SPI

GASKETED PLATE HEAT EXCHANGERS



Mod. SPI-A

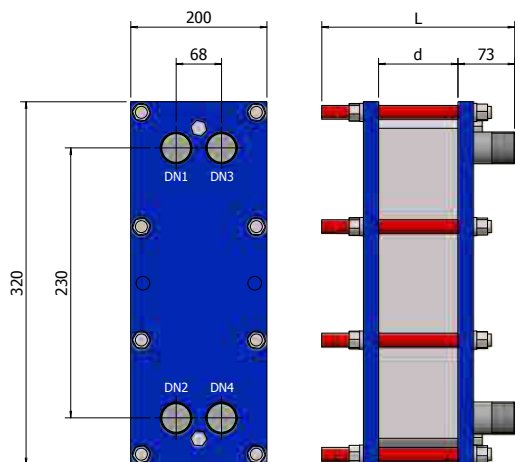

Mod. SPI-B

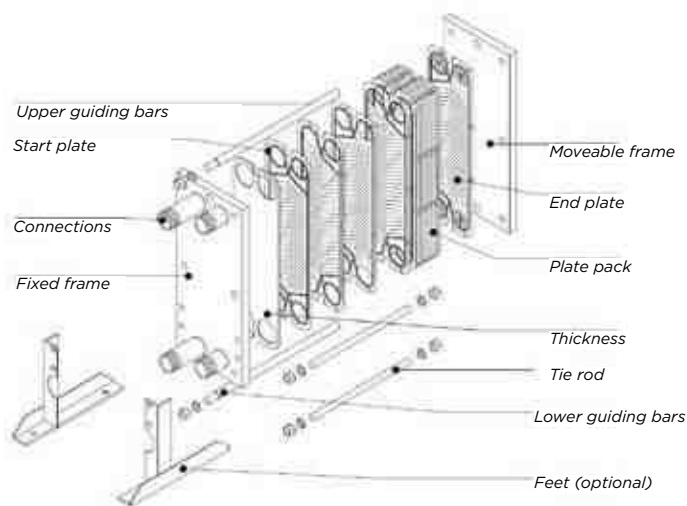
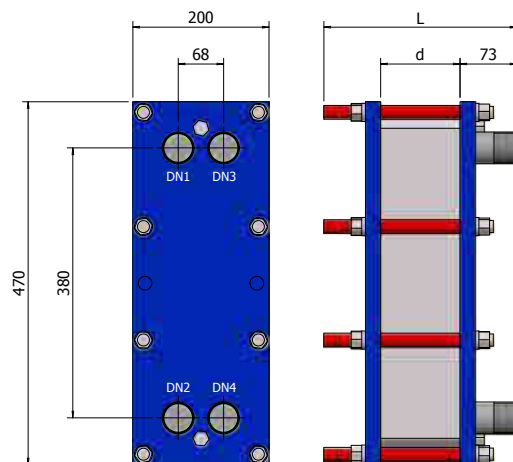

KEYWORD

DN1 (G 1 1/4): Secondary circuit heat exchanger inlet; **DN2 (G 1 1/4):** Secondary circuit heat exchanger outlet;
DN3 (G 1 1/4): Primary circuit heat exchanger inlet; **DN4 (G 1 1/4):** Primary circuit heat exchanger outlet.

+ 110°C
 HEAT EXCHANGER
 MAX TEMPERATURE

10 bar
 HEAT EXCHANGER
 MAX WORKING PRESSURE

REFERENCE STANDARDS

2014/68/UE Directive - ART. 4.3 without CE marking

CHARACTERISTICS:

- STRUCTURE: painted carbon steel
- PLATE: stainless steel AISI 316L
- CONNECTION: stainless steel AISI 316L
- GASKETS: EPDM

WARRANTY: 2 YEARS

DESCRIPTION:

Gasketed plate heat exchangers of SPI series can be used in different types of systems: production of sanitary hot water, heat pumps, heating and / or cooling systems, solar heating etc.

Advantages

- Ease in maintenance and cleaning operations;
- high efficiency;
- wide variety of applications.

DIMENSIONS SPI-A

MODEL	CODE	PLATE	TIGHTENING MEASURE (d) mm.	L mm.	PRIMARY: 80-60 SECONDARY: 15-45					PRIMARY: 65-45 SECONDARY: 15-45					NOTES
					POWER	PRIMARY		SECONDARY		POWER	PRIMARY		SECONDARY		
						CAPACITY	PRESSURE DROP	CAPACITY	PRESSURE DROP		CAPACITY	PRESSURE DROP	CAPACITY	PRESSURE DROP	
mm.	NR.	mm.	mm.	kW	lt/h	m.c.a.	lt/h	m.c.a.	kW	lt/h	m.c.a.	lt/h	m.c.a.		
SPI A09	L24BA09	9	28	251	47	2065	2,489	1355	1,096	19	830	0,441	548	0,200	
SPI A13	L24BA13	13	39		70	3076	2,504	2019	1,103	32	1397	0,560	923	0,254	
SPI A17	L24BA17	17	50		92	4042	2,503	2653	1,102	42	1834	0,557	1211	0,252	
SPI A21	L24BA21	21	61		114	5009	2,545	3288	1,120	58	2532	0,696	1673	0,314	
SPI A25	L24BA25	25	72		145	6371	2,964	4182	1,304	70	3056	0,731	2019	0,330	
SPI A29	L24BA29	29	84		166	7294	2,989	4787	1,315	83	3624	0,786	2394	0,354	
SPI A33	L24BA33	33	95	351	185	8128	2,992	5335	1,316	96	4191	0,844	2768	0,380	

DIMENSIONS SPI-B

MODEL	CODE	PLATE	TIGHTENING MEASURE (d) mm.	L mm.	PRIMARY: 80-60 SECONDARY: 15-45					NOTES
					POWER	PRIMARY		SECONDARY		
						CAPACITY	PRESSURE DROP	CAPACITY	PRESSURE DROP	
mm.	NR.	mm.	mm.	kW	lt/h	m.c.a.	lt/h	m.c.a.		
SPI B09	L24BB09	9	28	251	14	811	0,705	404	0,189	
SPI B13	L24BB13	13	39		24	1390	0,919	692	0,246	
SPI B17	L24BB17	17	50		34	1970	1,048	981	0,279	
SPI B21	L24BB21	21	61		44	2549	1,142	1269	0,304	
SPI B25	L24BB25	25	72		54	3128	1,220	1557	0,324	
SPI B29	L24BB29	29	84		64	3708	1,292	1846	0,342	
SPI B33	L24BB33	33	95	351	74	4287	1,362	2134	0,360	

The data in the tables are guidelines only. For other operating conditions (different fluids, different temperatures and / or different power) and specific sizing please contact our technical department: ut@elbi.it

Mod. SSB-A

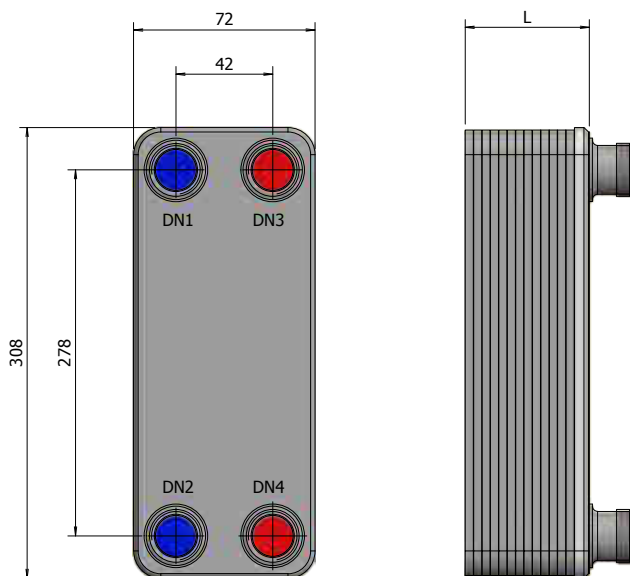

Mod. SSB-B

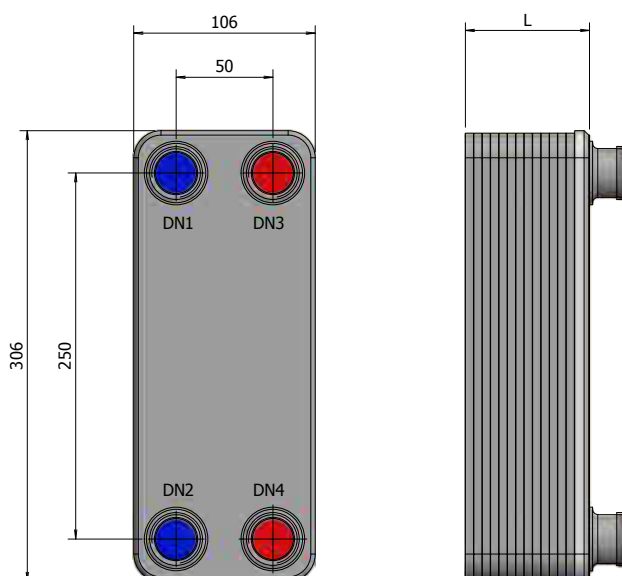

KEYWORD

DN1: Secondary circuit exchanger inlet/outlet (G3/4" in SSB-A; G 1" in SSB-B); **DN2:** Secondary circuit exchanger inlet/outlet (G3/4" in SSB-A; G 1" in SSB-B); **DN3:** Primary circuit exchanger inlet/outlet (G3/4" in SSB-A; G 1" in SSB-B); **DN4:** Primary circuit exchanger inlet/outlet (G3/4" in SSB-A; G 1" in SSB-B)

 + 195°C
HEAT EXCHANGER
MAX TEMPERATURE

 30 bar
HEAT EXCHANGER
MAX WORKING PRESSURE

REFERENCE STANDARDS

2014/68/UE Directive - ART. 4,3 without CE marking

CHARACTERISTICS:

- PLATE: stainless steel AISI 316L
- CONNECTION: stainless steel AISI 316L
- BRAZING: copper

WARRANTY: 2 YEARS

DESCRIPTION:

SSB brazed plate heat exchangers represent the most economical solution than the plate heat exchangers version. They can be used in different types of systems: production of sanitary hot water, heat pumps, heating and / or cooling systems, solar heating etc.

Advantages

- Compact size
- Affordability;
- Excellent resistance to corrosion;
- High efficiency;
- Wide variety of applications.

DIMENSIONS SSB-A

MODEL	CODE	PLATES	L	PRIMARY: 80-60 SECONDARY: 15-45					NOTES
				POWER	PRIMARY		SECONDARY		
					CAPACITY	PRESSURE DROP	CAPACITY	PRESSURE DROP	
mm.	NR.	mm.	kW	lt/h	m.c.a.	lt/h	m.c.a.		
SSB A14	L24WA14	14	36	36	1580	1,836	1040	1,326	
SSB A18	L24WA18	18	45	45	1980	1,734	1300	1,224	
SSB A20	L24WA20	20	50	54	2370	2,040	1560	1,326	
SSB A24	L24WA24	24	59	62	2720	1,938	1790	1,224	
SSB A30	L24WA30	30	73	71	3120	1,632	2050	1,020	
SSB A40	L24WA40	40	96	80	3520	1,224	2310	0,714	
SSB A50	L24WA50	50	119	118	5190	1,632	3410	0,918	
SSB A60	L24WA60	60	142	150	6590	1,836	4330	1,020	
SSB A80	L24WA80	80	188	197	8660	1,734	5690	1,020	

DIMENSIONS SSB-B

MODEL	CODE	PLATES	L	PRIMARY: 50-35 SECONDARY: 15-45					NOTES
				POWER	PRIMARY		SECONDARY		
					CAPACITY	PRESSURE DROP	CAPACITY	PRESSURE DROP	
mm.	NR.	mm.	kW	lt/h	m.c.a.	lt/h	m.c.a.		
SSB B10	L24WB10	10	27	19	1100	1,938	550	0,816	
SSB B20	L24WB20	20	50	39	2260	2,040	1130	0,714	
SSB B40	L24WB40	40	96	63	3650	1,428	1820	0,510	
SSB B50	L24WB50	50	119	88	5100	1,734	2540	0,612	
SSB B60	L24WB60	60	142	111	6430	1,836	3200	0,612	
SSB B80	L24WB80	80	188	147	8520	1,836	4240	0,612	

The data in the tables are guidelines only. For other operating conditions (different fluids, different temperatures and / or different power) and specific sizing please contact our technical department: ut@elbi.it

Heating element model **WITHOUT THERMOSTAT**

Water heating time from 15° C to 60 °C
(expressed in minutes) / The heating times outlined are approximate

CODE	Power (kW)	Voltage (Volt)	Connection	Length (mm)	150	200	300	400	500	800	1000	1500	2000	3000	5000
8601000	1	220 V / MF	G 1 1/4"	295	480 min.	630 min.	960 min.	1270 min.	1580 min.	2520 min.	3150 min.	4720 min.	6300 min.	9420 min.	15750 min.
8601650	1.65	220 V / MF	G 1 1/4"	450	285 min.	380 min.	580 min.	770 min.	970 min.	1550 min.	1920 min.	2870 min.	3820 min.	5740 min.	9550 min.
8602000	2	220 V / MF	G 1 1/4"	515	n.a.	n.a.	n.a.	640 min.	800 min.	1270 min.	1580 min.	2370 min.	3150 min.	4740 min.	7875 min.
8602600	2.6	220 V / MF	G 1 1/4"	675	n.a.	n.a.	n.a.	n.a.	n.a.	980 min.	1230 min.	1830 min.	2450 min.	3660 min.	6125 min.
8602601	2.6	220 V / MF	G 1 1/4"	360	180 min.	250 min.	370 min.	490 min.	630 min.	980 min.	1230 min.	1830 min.	2450 min.	3660 min.	6125 min.
8603300	3.3	220 V / MF	G 1 1/4"	825	n.a.	n.a.	n.a.	n.a.	n.a.	n.a.	n.a.	1450 min.	1940 min.	2900 min.	4850 min.
8603301	3.3	220 V / MF	G 1 1/4"	435	145 min.	200 min.	295 min.	390 min.	490 min.	780 min.	980 min.	1450 min.	1940 min.	2900 min.	4850 min.
8604001	4	220 V / MF	G 1 1/4"	510	n.a.	n.a.	n.a.	320 min.	410 min.	640 min.	800 min.	1200 min.	1600 min.	2400 min.	4000 min.
8705000	5	380 V / TF	G 1 1/2"	445	95 min.	140 min.	200 min.	260 min.	330 min.	520 min.	640 min.	950 min.	1300 min.	1900 min.	3250 min.
8706000	6	380 V / TF	G 1 1/2"	510	n.a.	n.a.	n.a.	220 min.	280 min.	430 min.	540 min.	800 min.	1060 min.	1600 min.	2650 min.
8708000	8	380 V / TF	G 1 1/2"	670	n.a.	n.a.	n.a.	n.a.	n.a.	330 min.	420 min.	610 min.	800 min.	1220 min.	2000 min.
8710000	10	380 V / TF	G 1 1/2"	820	n.a.	n.a.	n.a.	n.a.	n.a.	n.a.	n.a.	490 min.	640 min.	980 min.	1600 min.
8712000	12	380 V / TF	G 1 1/2"	970	n.a.	n.a.	n.a.	n.a.	n.a.	n.a.	n.a.	410 min.	540 min.	820 min.	1350 min.

n.a. = Heating element not applicable

Heating element model **WITH THERMOSTAT**

Water heating time from 15° C to 60 °C
(expressed in minutes) / The heating times outlined are approximate

CODE	Power (kW)	Voltage (Volt)	Connection	Length (mm)	150	200	300	400	500	800	1000	1500	2000	3000	5000
8T01500	1.5	230 V / MF	G 1 1/2"	320	320 min.	430 min.	640 min.	850 min.	1060 min.	1690 min.	2110 min.	3150 min.	4200 min.	6300 min.	10500 min.
8T02000	2.0	230 V / MF	G 1 1/2"	320	250 min.	330 min.	490 min.	640 min.	800 min.	1270 min.	1590 min.	2370 min.	3160 min.	4750 min.	7870 min.
8T02200	2.2	230 V / MF	G 1 1/2"	320	230 min.	300 min.	440 min.	590 min.	730 min.	1160 min.	1440 min.	2170 min.	2870 min.	4300 min.	7150 min.
8T02500	2.5	230 V / MF	G 1 1/2"	320	200 min.	270 min.	390 min.	520 min.	640 min.	1020 min.	1270 min.	1910 min.	2530 min.	3800 min.	6300 min.
8T03000	3	230 V / MF	G 1 1/2"	320	170 min.	220 min.	330 min.	430 min.	540 min.	850 min.	1060 min.	1600 min.	2110 min.	3160 min.	5250 min.
8T04000	4	400 V / TF	G 1 1/2"	400	130 min.	170 min.	250 min.	320 min.	410 min.	640 min.	800 min.	1200 min.	1600 min.	2400 min.	4000 min.
8T05000	5	400 V / TF	G 1 1/2"	500	n.a.	n.a.	n.a.	260 min.	330 min.	520 min.	640 min.	950 min.	1300 min.	1900 min.	3250 min.
8T06000	6	400 V / TF	G 1 1/2"	600	n.a.	n.a.	n.a.	220 min.	280 min.	430 min.	540 min.	800 min.	1060 min.	1600 min.	2650 min.
8T09000	9	400 V / TF	G 1 1/2"	700	n.a.	n.a.	n.a.	n.a.	n.a.	290 min.	360 min.	540 min.	710 min.	1060 min.	1760 min.
8T12000	12	400 V / TF	G 1 1/2"	850	n.a.	n.a.	n.a.	n.a.	n.a.	n.a.	n.a.	410 min.	540 min.	820 min.	1350 min.

n.a. = Heating element not applicable

MAINTENANCE:

The CUSTOMER HAS THE RIGHT to ask his trusted installation technician to carry out maintenance. It is the DUTY OF THE INSTALLATION TECHNICIAN to guarantee maintenance is STATE OF THE ART.

What points ensure state of the art maintenance?

1. SAFETY DEVICES

1.a EXPANSION TANKS ON THE PRIMARY CIRCUIT (HEATING SIDE): should be sized correctly and the suitable model chosen (e.g. ELBI ERCE series). Furthermore, the correct pre-charge value applied to the tank should be periodically checked.

1.b EXPANSION TANKS ON THE SECONDARY CIRCUIT (SANITARY SIDE): they should be correctly sized and the suitable model chosen (e.g. ELBI D-DV series). Furthermore, the correct pre-charge value applied to the vase should be periodically checked.

1.c SAFETY VALVE ON THE SECONDARY CIRCUIT (SANITARY SIDE): its functionality should be periodically controlled.

2. STORAGE TEMPERATURE

You are advised to store water at a temperature between 55 °C and 60 °C.

This is because at 55 °C you eliminate problems relating to Legionella and bacteria proliferation, while storage water at a temperature over 60 °C increases the formation of lime scale deposits and increases water abrasion.

Furthermore, with the temperature too high wear of the anode is increased and more frequent cylinder maintenance will be required.

3. WATER QUALITY

Sanitary water contained in the cylinders must comply with the parameters:

pH = 6,5 ÷ 8,0: this ensures you are not using water that is too aggressive for the internal glasslined surfaces of the cylinders.

Hardness = 15 °f ÷ 30 °f : this avoids excess lime scale deposits forming that can accumulate in the cylinder and on the magnesium anode isolating it electrically and making it inefficient. You are also advised to filter the inbound sanitary water in the cylinders to avoid sand, soil, rust, lime scale etc. particles building up on the bottom of the cylinder which can be found in the water mains.

4. MAGNESIUM ANODE

Before operating the cylinder, ensure the anodes are connected to the tank unit to guarantee electricity conduction. A correct anode connection guarantees cylinder protection against electro-chemical and electro-galvanic corrosion. It is therefore good practice to periodically check the wear status of the anode and any presence of a layer of lime scale that would make it inefficient and, if necessary, replace it.

N.B. For further information on maintenance of the cylinders and the various safety devices (expansion tanks, anode, safety valve, etc.), refer to the related installation use and maintenance sheets.

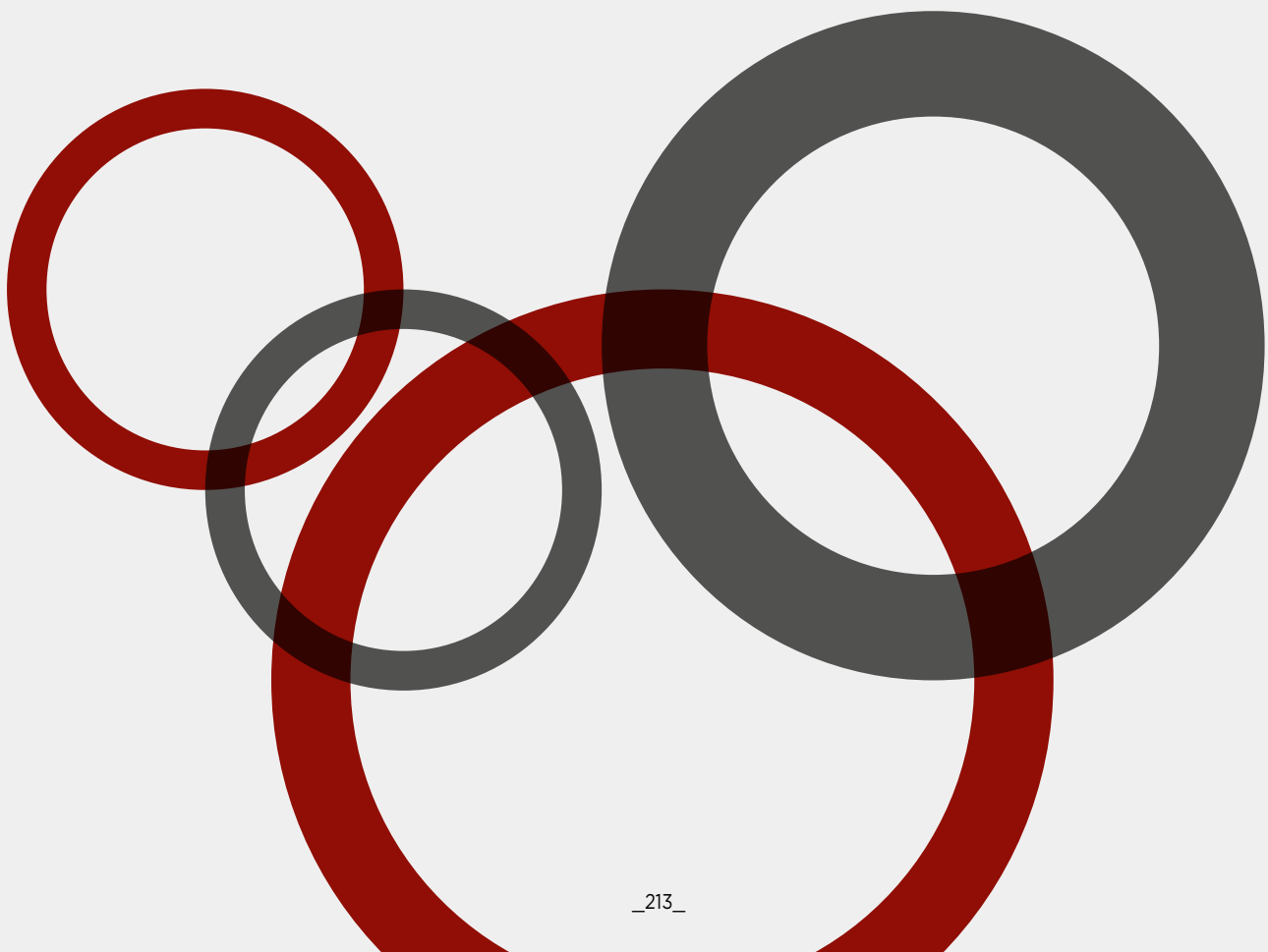

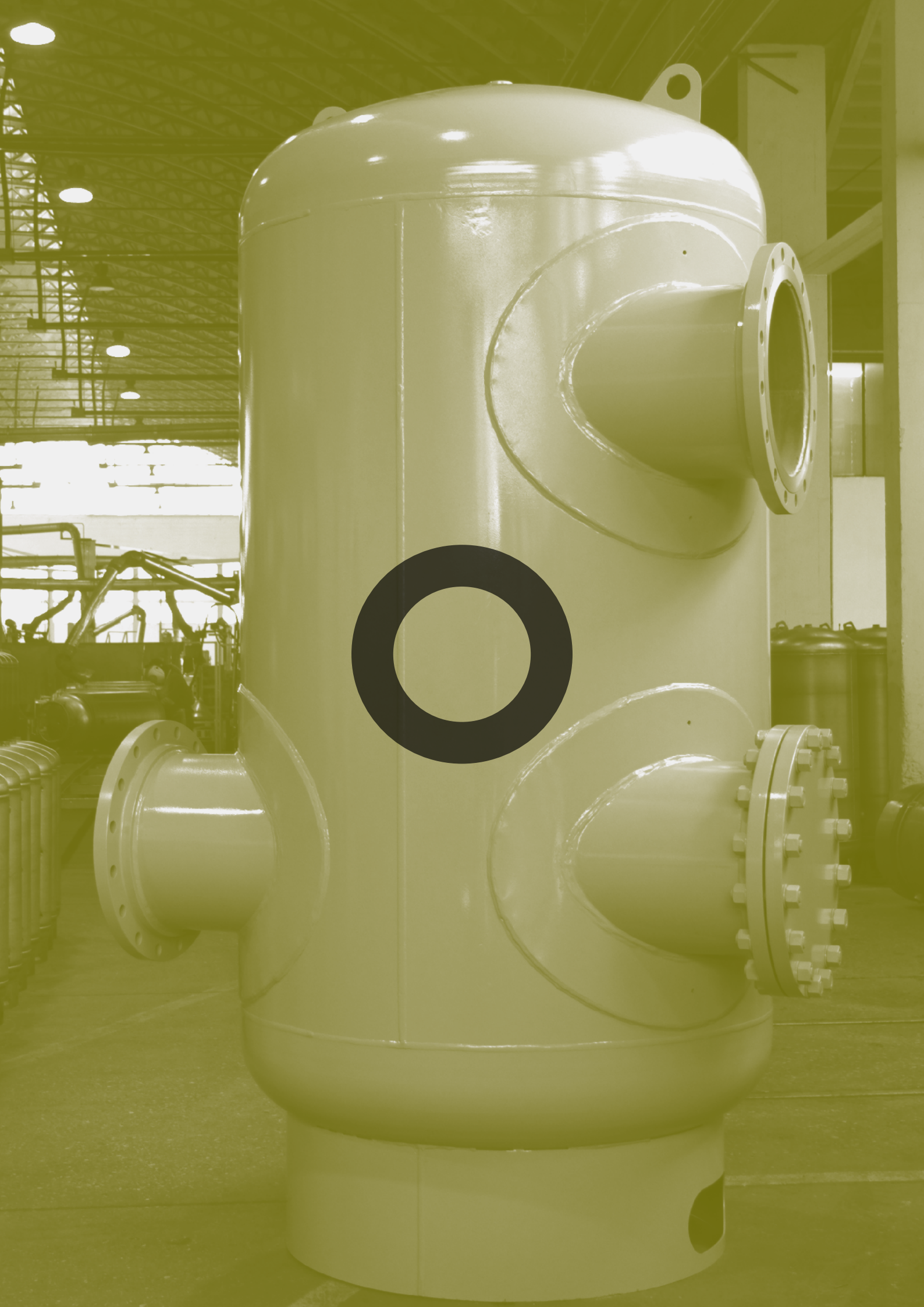



ASME

ASME

The ASME (HTL-DTL WTL-2) bladder tanks can be used both as expansion tanks for sanitary systems, therefore suitable for absorbing the various volumes caused by the increase in temperature, and as autoclaves in the sanitary systems for cold water. This dual use ensures protection against corrosion of the walls of the tank and suitability for contact with sanitary water.

The tanks are composed according to the strict ASME (American Society of Mechanical Engineers) standards and issued with Stamp U or Stamp UM.

AIR SEPARATOR

The ELBI ASME tangential air separators were designed to create a low velocity vortex to separate and remove air in the non-sanitary, closed circuits. Available with 2" to 24" connections, with or without an internal strainer in stainless steel.

The air separators are built according to strict ASME (American Society of Mechanical Engineers) standards and issued with Stamp U or Stamp UM.



ASME TANKS

212. AS - ASME:

AIR SEPARATORS (WITH OR WITHOUT STRAINER) (45 - 8,530 LITRES)

214. DT:

THERMAL EXPANSION TANKS FOR SANITARY WATER (8 - 5.000 LITRES)

216. HT:

HYDRONIC HEATING EXPANSION TANKS FOR HEATING SYSTEMS (150 PSI) (8 - 5.000 LITRES)

218. WTL:

COLD WATER BOOSTER TANKS: SANITARY BLADDER AUTOCLAVES FOR COLD WATER (200 PSI) (450 - 800 LITRES)

219. DIAGRAM OF PRESSURE DROPS FOR AIR SEPARATORS



AS - ASME AIR SEPARATORS

AIR SEPARATORS (WITH OR WITHOUT STRAINER)





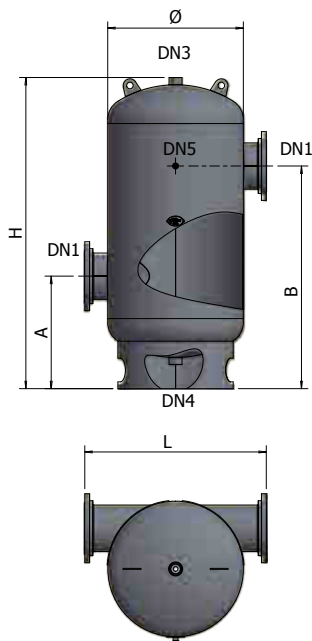

ASL

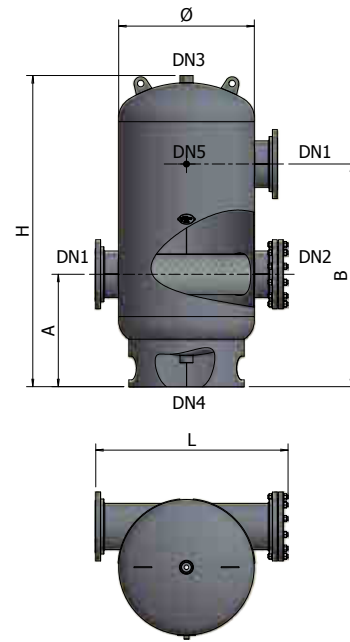

ASW



-  ASME U approved
-  ASME UM approved
-  For heating systems
-  For air conditioning systems

- Characteristics:**
- Working temperature: $-29^{\circ} / +190^{\circ}\text{C}$
 - Solvent painted, grey

Pressure drop
Consult the diagrams on page 225.

- Reference standard**
- ASME (American Society of Mechanical Engineers), stamp U and UM

WARRANTY: 2 YEARS

DIMENSIONS

MODEL	CODE			Pmax	Pmax									DN1	DN2	NOTES
		gal.	L.			PSI	bar	°F	°C	in.	mm	in.	mm			
ASL 020T	ADI4L33	12	45	150	10	375	190	13.8	350	26.3	668	22,7	576	2"	-	
ASL 025T	ADJ4L33	12	45	150	10	375	190	13.8	350	26.3	668	23,2	590	2-1/2"	-	
ASL 030	ADK4L33	12	45	150	10	375	190	13.8	350	26.3	668	24,3	617	3"	-	
ASL 040	ADM4L37	22.6	86	150	10	375	190	15.8	400	38	966	26,5	672	4"	-	
ASL 050	ADN4L37	22.6	86	150	10	375	190	15.8	400	38	966	20,9	530	5"	-	
ASL 060	ADO4J47	50	189	125	8,5	375	190	19.7	500	53.4	1353	27,1	688	6"	-	
ASL 080	ADP4J47	50	189	125	8,5	375	190	19.7	500	53.7	1363	29,6	752	8"	-	
ASL 100	ADQ4J58	189	715	125	8,5	375	190	31.5	800	72.3	1837	42,3	1074	10"	-	
ASL 120	ADR4J58	189	715	125	8,5	375	190	31.5	800	72.3	1837	41,3	1050	12"	-	
ASL 140	ADS4J64	330	1249	125	8,5	375	190	37.4	950	92.8	2357	45,7	1160	14"	-	
ASL 160	ADT4J72	666	2521	125	8,5	375	190	49.2	1250	112	2844	61,5	1562	16"	-	
ASL 180	ADU4J77	1179	4463	125	8,5	375	190	61	1550	120	3043	67,6	1716	18"	-	
ASL 200	ADV4J84	1507	5705	125	8,5	375	190	61	1550	123.7	3141	72,3	1836	20"	-	
ASL 240	ADW4J92	2253	8530	125	8,5	375	190	61	1550	188.5	4789	85	2160	24"	-	
ASW 020T	AEI4L33	12	45	150	10	375	190	13.8	350	26.3	668	22,7	576	2"	2"	
ASW 025T	AEJ4L33	12	45	150	10	375	190	13.8	350	26.3	668	23,2	590	2-1/2"	2-1/2"	
ASW 030	AEK4L33	12	45	150	10	375	190	13.8	350	26.3	668	24,3	617	3"	3"	
ASW 040	AEM4L37	22.6	86	150	10	375	190	15.8	400	38	966	26,5	672	4"	4"	
ASW 050	AEN4L37	22.6	86	150	10	375	190	15.8	400	38	966	20,9	530	5"	5"	
ASW 060	AEO4J47	50	189	125	8,5	375	190	19.7	500	53,4	1356	27,1	688	6"	6"	
ASW 080	AEP4J47	50	189	125	8,5	375	190	19.7	500	53,7	1363	29,6	752	8"	8"	
ASW 100	AEQ4J58	189	715	125	8,5	375	190	31.5	800	72,3	1837	42,3	1074	10"	10"	
ASW 120	AER4J58	189	715	125	8,5	375	190	31.5	800	72,3	1837	41,3	1050	12"	12"	
ASW 140	AES4J64	330	1249	125	8,5	375	190	37.4	950	92,8	2357	45,7	1160	14"	14"	
ASW 160	AET4J72	666	2521	125	8,5	375	190	49.2	1250	112	2844	61,5	1562	16"	16"	
ASW 180	AEU4J77	1179	4463	125	8,5	375	190	61	1550	120	3049	67,6	1716	18"	18"	
ASW 200	AEV4J84	1507	5705	125	8,5	375	190	61	1550	123,7	3141	72,3	1836	20"	20"	
ASW 240	AEW4J92	2253	8530	125	8,5	375	190	61	1550	188,5	4789	85	2160	24"	24"	





DT - THERMAL EXPANSION TANKS

FOR SANITARY WATER

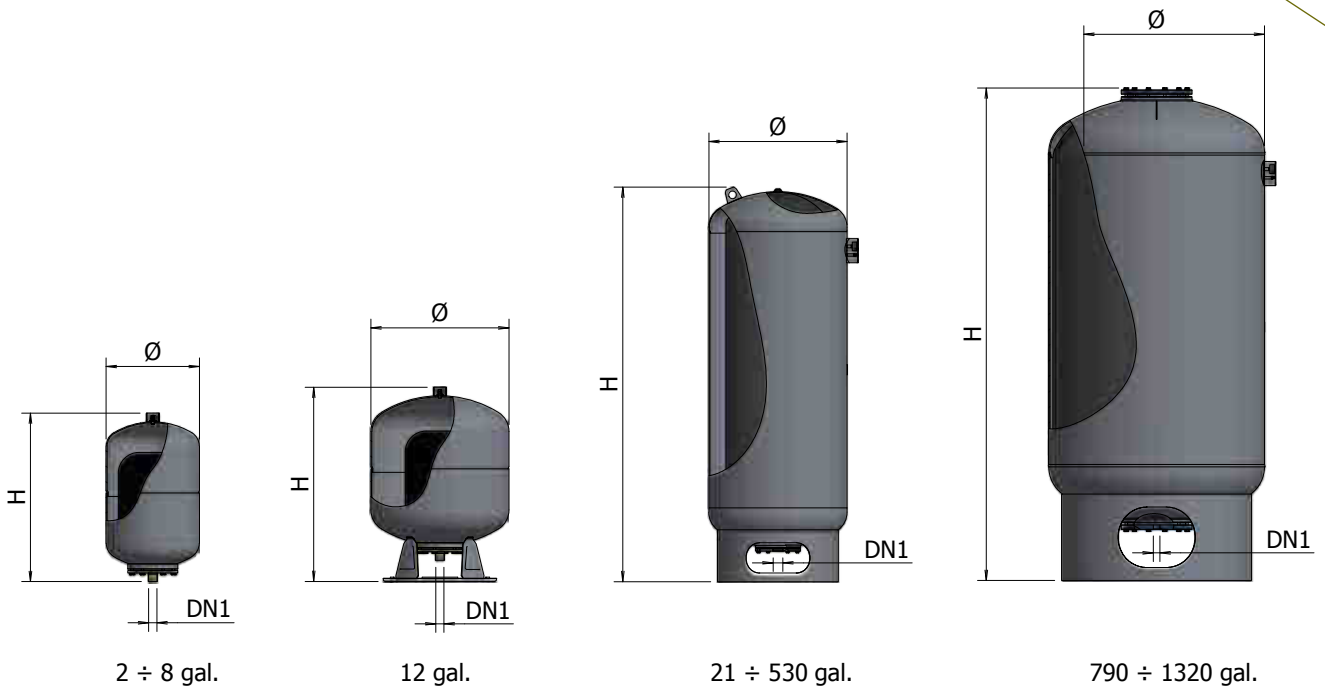

- ASME U approved
- ASME UM approved
- For heating systems
- For air conditioning systems
- For drinking water
- For pressurisation systems









- Characteristics:**
- Working temperature: -10° / +115°C
 - Solvent painted, grey
 - Stainless steel counter-flange

- Reference standard**
- ASME (American Society of Mechanical Engineers), stamp U and UM

WARRANTY: 2 YEARS



DIMENSIONS

MODEL	CODE			Ppre		Pmax								DN1	NOTES
		gal.	L.	PSI	bar	PSI	bar	°F	°C	in.	mm	in.	mm		
DTS-8	AA04L16 D0000	2	8	40	3	150	10	240	115	10.6	270	10.2	260	3/4" NPT	
DTS-19	AA04L24 D0000	5.0	19	40	3	150	10	240	115	10.6	270	19.3	490	3/4" NPT	
DTS-30	AA04L30 D0000	8.0	30	40	3	150	10	240	115	15.8	400	15.3	390	3/4" NPT	
DTS-45	AA14L33 D0000	12.0	45	55	4	150	10	240	115	15.8	400	22.4	570	3/4" NPT	
DTS-80	AA14L37 D0000	21.0	80	55	4	150	10	240	115	15.8	400	34.9	890	1" NPT	
DTS-100	AA14L38 D0000	26.5	100	55	4	150	10	240	115	19.7	500	37.3	950	1" NPT	
DTS-140	AA14L42 D0000	37.0	140	55	4	150	10	240	115	19.7	500	43.3	1100	1-1/4" NPT	
DTL-170	AA34L45 D0000	44.0	170	55	4	150	10	240	115	19.7	500	48.7	1240	1-1/4" NPT	
DTL-200	AA34L47 D0000	53.0	200	55	4	150	10	240	115	21.7	550	47.2	1200	1-1/4" NPT	
DTL-300	AA34L51 D0000	80.0	300	55	4	150	10	240	115	25.6	650	49.4	1255	1-1/4" NPT	
DTL-400	AA34L53 D0000	105.0	400	55	4	150	10	240	115	25.6	650	57.9	1470	1-1/4" NPT	
DTL-450	AA34L54 D0000	120.0	450	55	4	150	10	240	115	29.5	750	54.7	1390	1-1/4" NPT	
DTL-500	AA44L55 D0000	132.0	500	55	4	150	10	240	115	29.5	750	59.1	1500	1-1/4" NPT	
DTL-600	AA44L57 D0000	160.0	600	55	4	150	10	240	115	29.5	750	66.7	1692	2" NPT	
DTL-800	AA44L60 D0000	210.0	800	55	4	150	10	240	115	29.5	750	90.2	2290	2" NPT	
DTL-1000	AA44L62 D0000	265.0	1000	55	4	150	10	240	115	31.5	800	90.2	2290	2" NPT	
DTL-1200	AA44L64 D0000	320.0	1200	55	4	150	10	240	115	35.4	900	95.9	2435	2" NPT	
DTL-1400	AA44L66 D0000	370.0	1400	55	4	150	10	240	115	37.4	950	97.6	2480	3" NPT	
DTL-1600	AA44L68 D0000	420.0	1600	55	4	150	10	240	115	41.3	1050	98.4	2500	3" NPT	
DTL-2000	AA44L70 D0000	530.0	2000	55	4	150	10	240	115	43.3	1100	107.1	2720	3" NPT	
DTL-3000	AA44L74 D0000	790.0	3000	55	4	150	10	240	115	51.2	1300	113.0	2870	3" NPT	
DTL-4000	AA44L77 D0000	1060.0	4000	55	4	150	10	240	115	61.0	1550	113.5	2885	3" NPT	
DTL-5000	AA44L80 D0000	1320.0	5000	55	4	150	10	240	115	61.0	1550	123.2	3130	3" NPT	

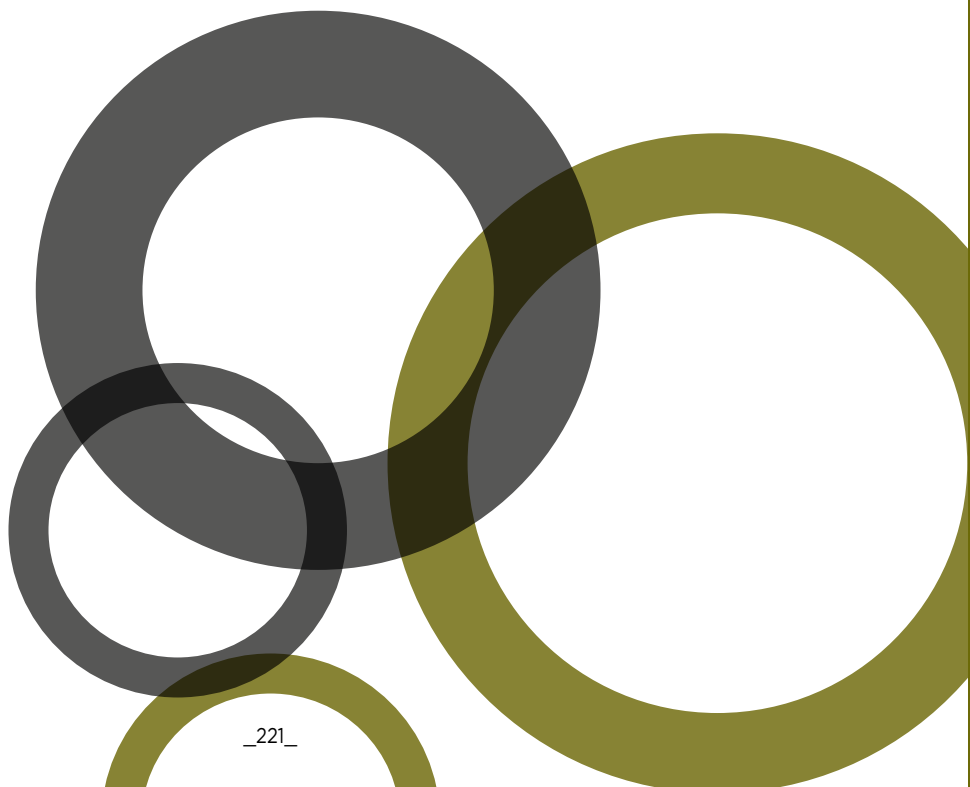

HT - HYDRONIC HEATING EXPANSION TANKS

FOR HEATING SYSTEMS (150 PSI)

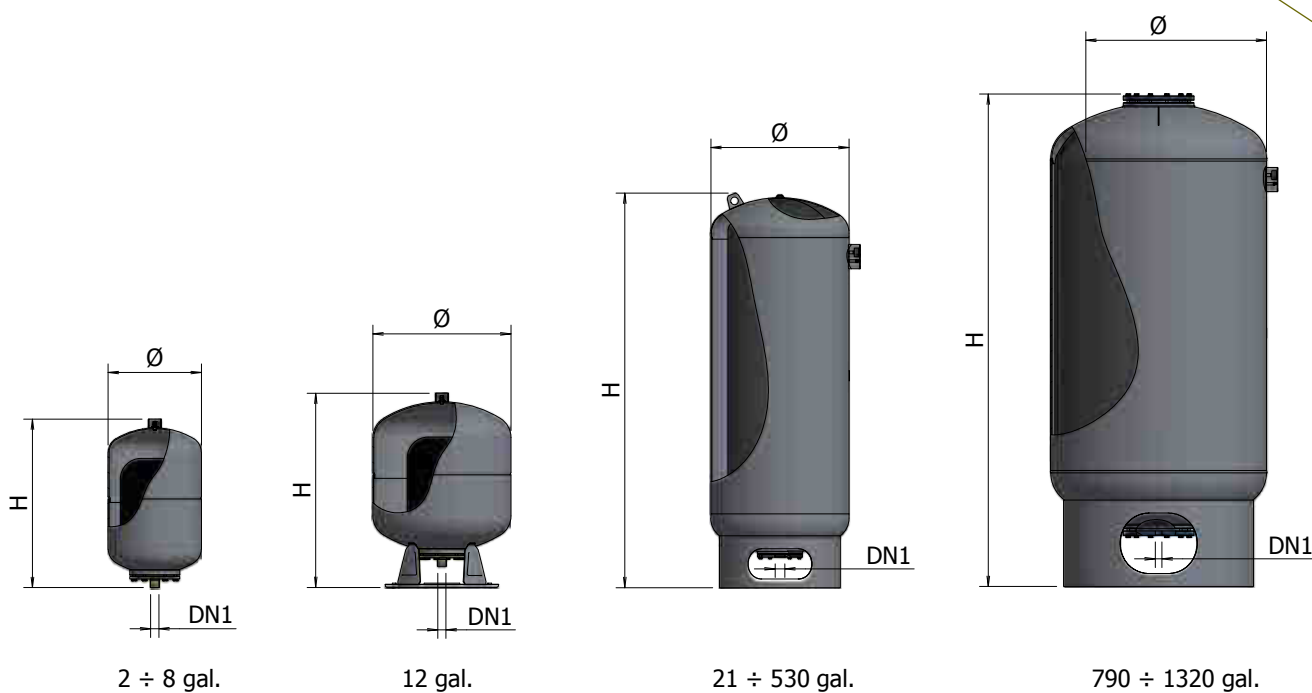

-  ASME U approved
-  ASME UM approved
-  For heating systems
-  For air conditioning systems
-  For drinking water
-  For pressurisation systems

Characteristics:

- Working temperature: -10° / $+115^{\circ}\text{C}$
- Solvent painted, grey
- Counter-flange with Top-Pro treatment (8 - 1200 litres)
- Painted counter-flange (1,400 - 5.000)

Reference standard

- ASME (American Society of Mechanical Engineers), stamp U and UM

WARRANTY: 2 YEARS

DIMENSIONS

MODEL	CODE			Ppre		Pmax								DN1	NOTES
		gal.	L.	PSI	bar	PSI	bar	°F	°C	in.	mm	in.	mm		
HTS-8	AA04L16 H0000	2	8	12	1	150	10	240	115	10.6	270	10.2	260	3/4" NPT	
HTS-19	AA04L24 H0000	5.0	19	12	1	150	10	240	115	10.6	270	19.3	490	3/4" NPT	
HTS-30	AA04L30 H0000	8.0	30	12	1	150	10	240	115	15.8	400	15.3	390	3/4" NPT	
HTS-45	AA14L33 H0000	12.0	45	12	1	150	10	240	115	15.8	400	22.4	570	3/4" NPT	
HTS-80	AA14L37 H0000	21.0	80	12	1	150	10	240	115	15.8	400	34.9	890	1" NPT	
HTS-100	AA14L38 H0000	26.5	100	12	1	150	10	240	115	19.7	500	37.3	950	1" NPT	
HTS-140	AA14L42 H0000	37.0	140	12	1	150	10	240	115	19.7	500	43.3	1100	1-1/4" NPT	
HTL-170	AA34L45 H0000	44.0	170	12	1	150	10	240	115	19.7	500	48.7	1240	1-1/4" NPT	
HTL-200	AA34L47 H0000	53.0	200	12	1	150	10	240	115	21.7	550	47.2	1200	1-1/4" NPT	
HTL-300	AA34L51 H0000	80.0	300	12	1	150	10	240	115	25.6	650	49.4	1255	1-1/4" NPT	
HTL-400	AA34L53 H0000	105.0	400	12	1	150	10	240	115	25.6	650	57.9	1470	1-1/4" NPT	
HTL-450	AA34L54 H0000	120.0	450	12	1	150	10	240	115	29.5	750	54.7	1390	1-1/4" NPT	
HTL-500	AA44L55 H0000	132.0	500	12	1	150	10	240	115	29.5	750	59.1	1500	1-1/4" NPT	
HTL-600	AA44L57 H0000	160.0	600	12	1	150	10	240	115	29.5	750	66.7	1695	2" NPT	
HTL-800	AA44L60 H0000	210.0	800	12	1	150	10	240	115	29.5	750	90.2	2290	2" NPT	
HTL-1000	AA44L62 H0000	265.0	1000	12	1	150	10	240	115	31.5	800	90.2	2290	2" NPT	
HTL-1200	AA44L64 H0000	320.0	1200	12	1	150	10	240	115	35.4	900	95.9	2435	2" NPT	
HTL-1400	AA44L66 H0000	370.0	1400	12	1	150	10	240	115	37.4	950	97.6	2480	3" NPT	
HTL-1600	AA44L68 H0000	420.0	1600	12	1	150	10	240	115	41.3	1050	98.4	2500	3" NPT	
HTL-2000	AA44L70 H0000	530.0	2000	12	1	150	10	240	115	43.3	1100	107.1	2720	3" NPT	
HTL-3000	AA44L74 H0000	790.0	3000	12	1	150	10	240	115	51.2	1300	113.0	2870	3" NPT	
HTL-4000	AA44L77 H0000	1060.0	4000	12	1	150	10	240	115	61.0	1550	113.5	2885	3" NPT	
HTL-5000	AA44L80 H0000	1320.0	5000	12	1	150	10	240	115	61.0	1550	123.2	3130	3" NPT	



WTL - 2 HYDRONIC HEATING EXPANSION TANKS

SANITARY BLADDER AUTOCLAVES FOR COLD WATER (200 PSI)

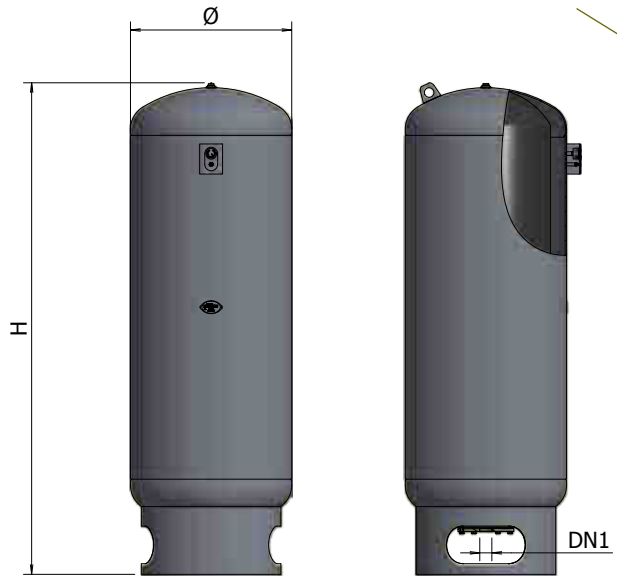

120 ÷ 210 gal.

DIMENSIONS

MODEL	CODE													DN1	NOTES
		gal.	L.	PSI	bar	PSI	bar	°F	°C	in.	mm	in.	mm		
WTL2-450	AA34P54 W0000	120.0	450	55	4	200	13,8	240	115	25.6	650	70.0	1780	2" NPT	
WTL2-500	AA44P55 W0000	132.0	500	55	4	200	13,8	240	115	25.6	650	76.0	1930	2" NPT	
WTL2-680	AA44P58 W0000	180.0	680	55	4	200	13,8	240	115	29.5	750	79.3	2015	2" NPT	
WTL2-800	AA44P60 W0000	210.0	800	55	4	200	13,8	240	115	29.5	750	91.1	2315	2" NPT	

- ASME U approved
- ASME UM approved
- For heating systems
- For air conditioning systems
- For drinking water
- For pressurisation systems

Characteristics:

- Working temperature: -10° / +115°C
- Solvent painted, grey
- Counter-flange with Top-Pro treatment

Reference standard

- ASME (American Society of Mechanical Engineers), stamp U

Well pressure tanks for use in hydropneumatic systems.

WARRANTY: 2 YEARS

ASL

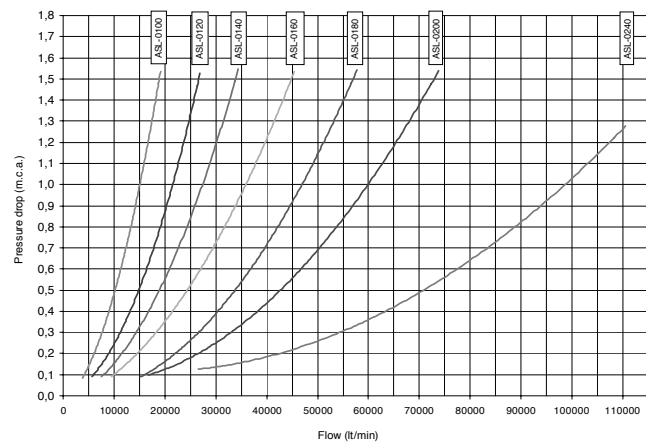
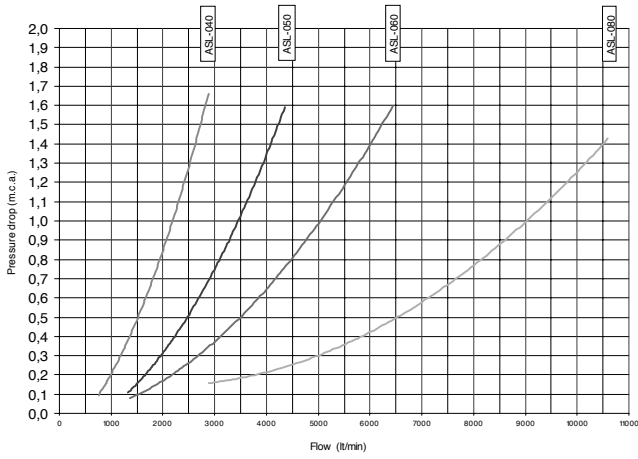
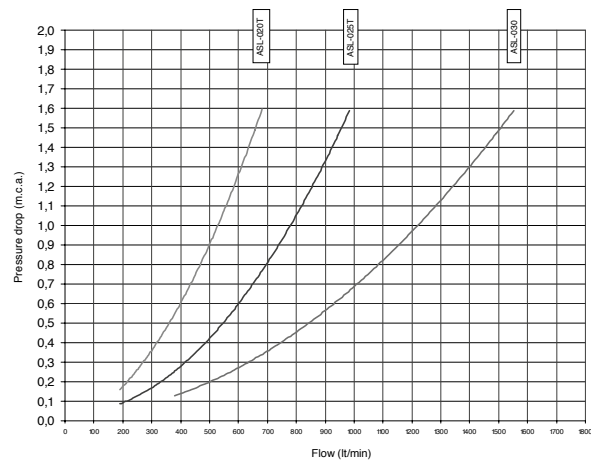

ASW

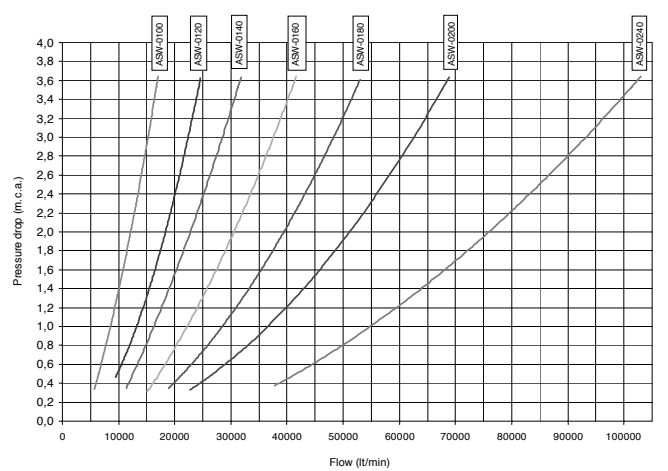
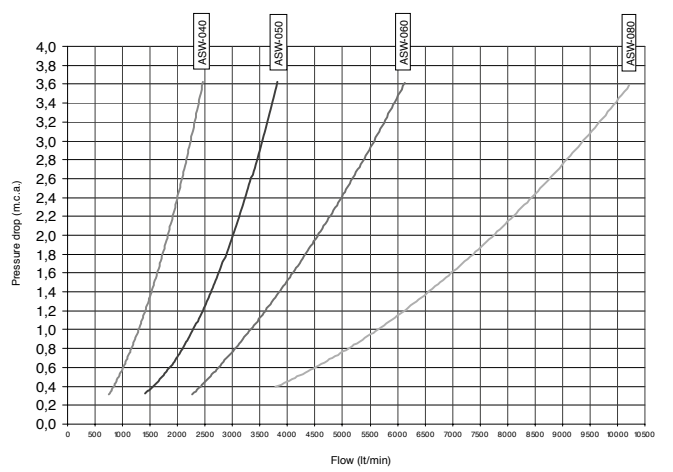
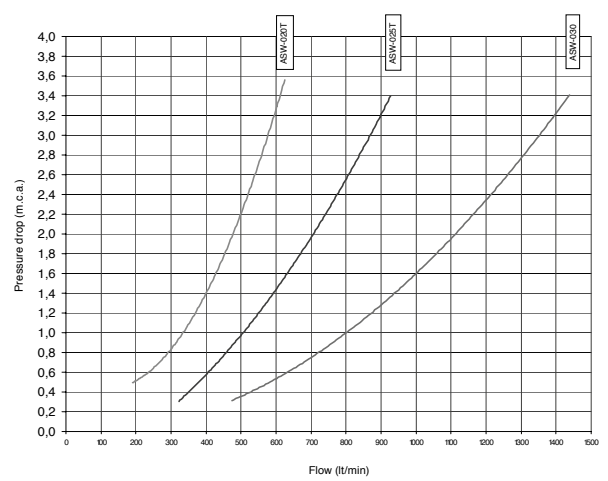

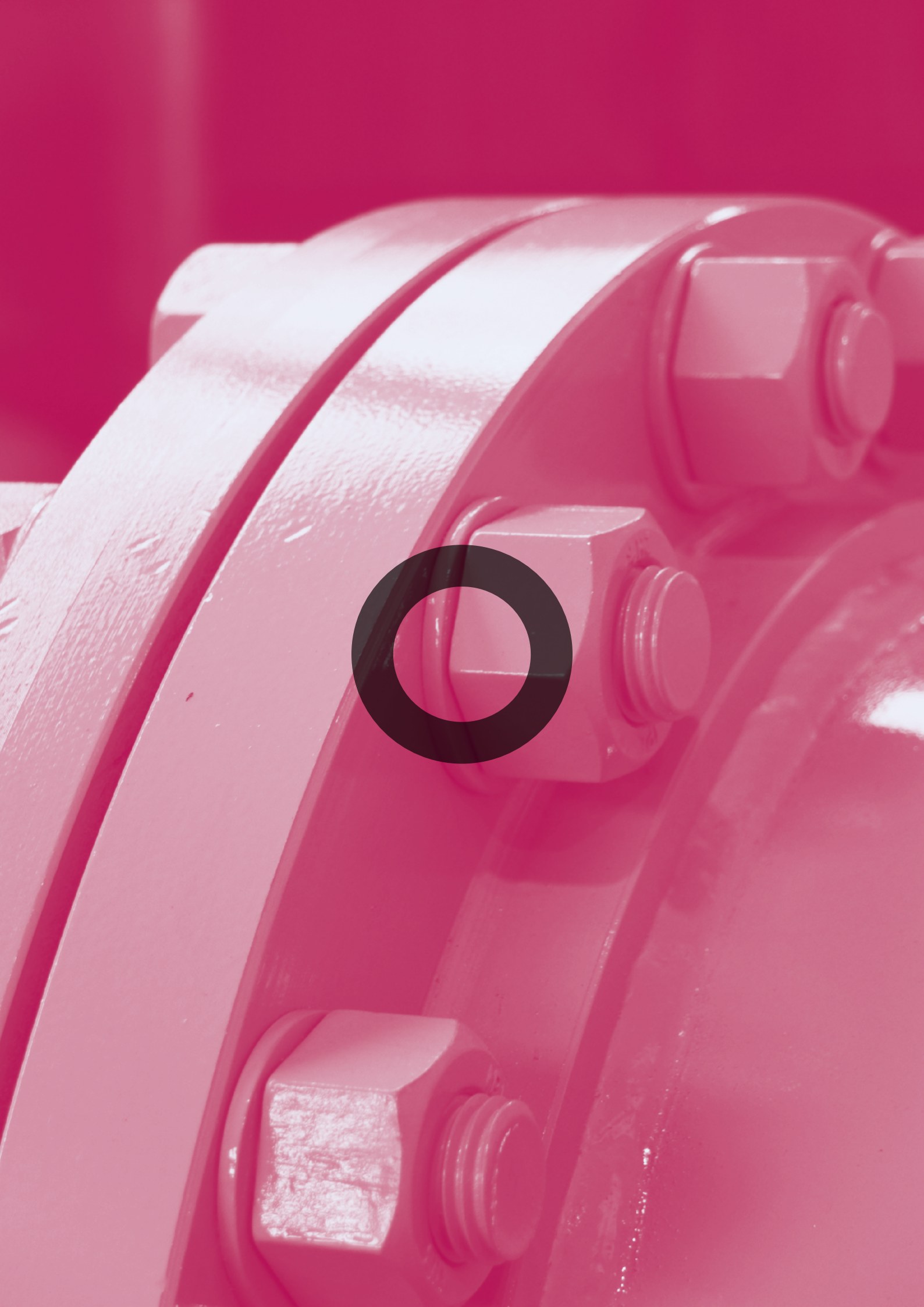

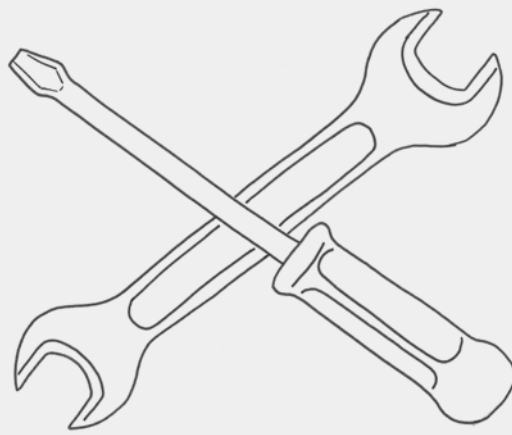

ACCESSORIES AND SPARE PARTS

CE BLADDERS

USE	IN EPDM RUBBER		IN BUTYL RUBBER	
	Code	NOTES	Code	NOTES
SANY S 0.5/SANY S 1	-		Q110005 00002	
SANY S 2/SANY L 3	-		Q110007 00002	
AC-2 / HX-2F	-		Q110008 00002	
SANY S 3/SANY S 4/SANY L 6	-		Q110009 00002	
AC-5 / AC-8	Q120016 00002		Q110016 00002	
HM-24/HS-24/AC-18/AC-25/AC-25 GPM/AF-24/ AS-25	Q120027 00002		Q110027 00002	
AC-20 PN-25/AF-35/AFV-50/AFH-50	Q120034 00002		Q110034 00002	
HM-60/AFV-60/AFH-60/AFV-80/AFH-80/AFV-100/AFH-100	Q120038 00002		Q110038 00002	
AFV-150 (**)/AFV-200/AFH-200	Q120047 00002		Q110047 00002	
AFV-150 (*)	Q120043 00002		Q110043 00002	
AFV-300/AFH-300	Q120051 00002		Q110051 00002	
AFV-500	Q120055 00002		Q110055 00002	

(*) Production since march 2015
 (**) Production up to february 2015

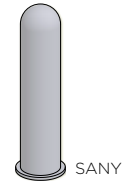

MOD. 1

MOD. 2
Production up to 12/2010

USE	MOD. 1		MOD. 2	
	Code	NOTES	Code	NOTES
AF 500-16	Q141055 01002		Q141055 00002	
DL 750/AFL-750*	Q141059 01002		Q141059 00002	
DL-1000/AFL-1000*	Q141062 01002		Q141062 00002	
DL-2000/AFL-2000*	Q140070 01002		Q140070 00002	
DL-3000/DL-5000/AFL-3000*/ AFL-5000*	Q140080 00002		-	

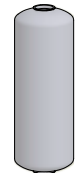

MOD. 1

MOD. 2

* Tanks out of production since 12/2010: PAY ATTENTION TO THE MANUFACTURING DATE BEFORE ORDERING THE BLADDER

ASME BLADDERS

USE	IN EPDM RUBBER		IN BUTYL RUBBER	
	Code	NOTES	Code	NOTES
ASME 8	Q120027 00002		Q110027 00002	
ASME 19/ASME 30/ASME 45	Q120034 00002		Q110034 00002	
ASME 80/ASME 100	Q120038 00002		Q110038 00002	
ASME 140	Q120047 00002		Q110047 00002	
ASME 170/ASME 200/ASME 300	Q120051 00002		Q110051 00002	
ASME 400/ASME 450/ASME 500	Q120055 00002		Q110055 00002	



MOD. 1

MOD. 2
Production up to 12/2010

USE	MOD. 1		MOD. 2	
	Code	NOTES	Code	NOTES
ASME 600/ASME 450-200/ASME 500-200	Q141055 01002		Q141055 00002	
ASME 680-200	Q141059 01002		Q141059 00002	
ASME 800/ASME - 1000/ASME 1200/ASME 800-200	Q141062 01002		Q141062 00002	
ASME 1400/ASME 1600/ASME-2000	Q140070 01002		Q140070 00002	
ASME-3000/ASME-4000/ASME-5000	Q140080 00002		-	

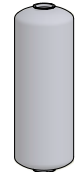

MOD. 1

MOD. 2

* Tanks out of production since 12/2010: PAY ATTENTION TO THE MANUFACTURING DATE BEFORE ORDERING THE BLADDER

BLADDER AUTOCLAVES

COUNTER-FLANGE FOR AUTOCLAVES WITH REPLACEABLE BLADDER (ASME)

MATERIAL	USE	DIAM. Ø (MM)	WATER CONNECTION	CODE	NOTES
Steel Top-Pro	HTS-8/19/30/45/80/100	145	1" NTP	3A14540 00002	
	HTS-140/170/200/300/400/450/500	260	1 1/4" NTP (female thread)	3A260QG 00002	
	HTS-600/800/1000/1200	260	2" NTP (female thread)	3A260RG 00002	
	WTL2-450/500/680/800 (200 PSI)	260	2" NTP (female thread)	3A260RI V0022	
Glasslined steel	HTS-1400/1600/2000/3000/4000/5000	410	3" NTP (female thread)	3A410HL 00002	
Stainless steel	DTS-8/19/30/45/80/100	145	1" NTP	3A1453B V0012	
	DTS-140/170/200/300/400/450/500	260	1 1/4" NTP (female thread)	37260QG V0012	
	DTS-600/800/1000/1200	260	2" NTP (female thread)	37260RG V0012	
	DTS-1400/1600/2000/3000/4000/5000	410	3" NTP (female thread)	37410HL V0012	

COUNTER-FLANGE FOR AUTOCLAVES WITH REPLACEABLE BLADDER (CE PRODUCTS)

MATERIAL	USE	DIAM. Ø (MM)	WATER CONNECTION	CODE	NOTES
Galvanized steel	SANY-L 3/ AC-2/5/8 SANY-S 0,5/1/2/4 DE-8	95	1/2" GAS	3A08627 00002	
	AC-18/25; AC-25 GPM; AS-25; AF-35 AFV-50/60/80/100/150 (*) AFH-50/60/80/100 AFV-Z-60/80/100/150 (*) DE-18/24	145	1" NPT	3A14539 00002	
	AFV-150 (**)/200/300/500 AFH 200/300 AFV-Z-200/300/500	260,5 (nr.6 holes) (**)	1,1/4" NPT	3A27448 00002	
	AFV-200/300/500 AFH-200/300 AFV-Z-200/300/500	260,5 (nr.8 holes) (*)	1,1/4" NTP	3A27449 00002	
	-	95	1/2" GAS	3E08620 00002	
	HX-2F	95	1/2" GAS	3E08623 00002	
	HM-24; HC-24; HM-V60 HM-24 GPM; HM-H-60	145	1" GAS	3E14835 00002	
Steel Top-Pro	AC-20 PN25	145	3/4" GAS	3A14550 00002	
	AF-24/16; AFV-100/16	145	1" NTP	3A14540 00002	
	AFV-200/300 (16 bar)	260	1,1/4" NTP (female thread)	3A260QG 00002	
	AFV-500/16 DL-750/1000 /10/16 bar)	260	2" GAS (female thread)	3A2586F 00002	
Glasslined steel	DL-2000/3000/5000 (10 bar) and 16 bar models	410	3" GAS (female thread)	3A411ZL 00002	



(*) Production since march 2015
 (**) Production up to february 2015

EXPANSION TANKS FOR HEATING
WALL FIXING BRACKET FOR ER - ERCE SERIES

ITEM	CODE	NOTES
Wall fixing bracket for ER-5/18	8200225	
Wall fixing bracket for ER-24	8200235	
Wall fixing bracket for ERCE-35	8200245	

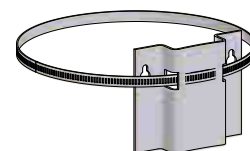
VALVES FOR EXPANSION TANKS

ITEM	CODE	NOTES
Double retention valve 3/4"	L13E000	
Double retention valve 1"	L13G000	
Thermostatic mixing valve 3/4"	L27E000	

GALVANIZED TANKS AND AF AUTOCLAVES

SAFETY VALVES

CODE	MODEL	CALIBRATION (BAR)	AIR LITRES / MIN.	CONNECTION	ALTURA (MM)	NOTES
L17CH00	C-10/6	6	4.668	3/8"	62	
L17CJ00	C-10/8	8	6.019			
L17CLO0	C-10/10	10	7.370			
L17CNO0	C-10/12	12	8.7021			
L17CRO0	C-10/16	16	11.424			
L17GH00	B-20/6	6	21.647	1"	141	
L17GJ00	B-20/8	8	27.914			
L17GLO0	B-20/10	10	34.180			
L17GNO0	B-20/12	12	40.447			
L17GRO0	B-20/16	16	52.979			
L17HH00	F-25/6	6	36.359	1,1/4"	195	
L17HJ00	F-25/8	8	46.884			
L17HLO0	F-25/10	10	57.409			
L17HNO0	F-25/12	12	67.934			
L17HRO0	F-25/16	16	88.984			
L17KH00	F-40/6	6	74.684	2"	340	
L17KJ00	F-40/8	8	96.303			
L17KLO0	F-40/10	10	117.922			
L17KNO0	F-40/12	12	139.541			
L17KRO0	F-40/16	16	183.866			

CE tested and approved safety valves supplied on demand.



GAUGES

ITEM	CALIBRATION (BAR)	CODE	NOTES
Gauge UNI EN 837-1	6	L11BH00	
	8	L11BJ00	
	10	L11BL00	
	12	L11BN00	
	16	L11BR00	



GALVANIZED TANKS

INCREASES FOR SPECIAL INSTALLATIONS

INSPECTION OPENINGS	CODE	AVAILABLE ON:	NOTES
Handhole 100x150	8000420	Lt. 1.500 -10.000	
Manhole 300x400	8000580	Lt. 3.000 -10.000	



HOT WATER TANKS

COIL EXCHANGERS IN FINNED COPPER FOR BG SERIES TANKS

CODE	MODEL	SURF. M ²	NOTES
2140180	SC-180	1,8	
2140250	SC-250	2,5	
2140320	SC-320	3,2	
2140450	SC-450	4,5	

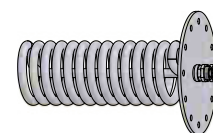

ACCESSORIES FOR BG SERIES CYLINDERS

CODE	MODEL	NOTES
3A310XD 00002	GLASSLINED COUNTER-FLANGE Ø 310	
4203050 V0022	GASKET FOR FINNED COPPER COIL "SC" TYPE	
8000130	COMPLETE THERMOMETER 0° - 120°C, DN 1/2"	
8000140	THERMOSTAT	

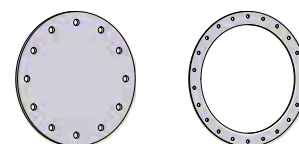

STAINLESS STEEL HEAT EXCHANGERS

CODE	MODEL	NOTES
2980040	Stainless steel heat exchanger 0.40 m ² for 100 litre cylinders	Horizontal, Ø 260 - 6 Holes
2980060	Stainless steel heat exchanger 0.60 m ² for 150 litre cylinders	
2980079	Stainless steel heat exchanger 0.79 m ² for 200 litre cylinders	
2980090	Stainless steel heat exchanger 0.90 m ² for 300 litre cylinders	
2980125	Stainless steel heat exchanger 1.25 m ² for 500 litre cylinders	
2950075	Stainless steel heat exchanger 0.75 m ² for 300 litre cylinders	Vertical, Ø 330 - 15 Holes
2950100	Stainless steel heat exchanger 1.00 m ² for 500 litre cylinders	
2950150	Stainless steel heat exchanger 1.60 m ² for 750 litre cylinders	
2960250	Stainless steel heat exchanger 2.50 m ² for 1000 litre cylinders	
2950150 V0012	Stainless steel heat exchanger mq. 1,6 per BF-3 1.500	Vertical, Ø 420 - 22 Holes
2960250 V0012	Stainless steel heat exchanger mq. 2,5 per BF-3 2.000	
2950300 V0012	Stainless steel heat exchanger 3.00 m ² for 1500 litre cylinders	
2950400 V0012	Stainless steel heat exchanger 4.00 m ² for 2000 litre cylinders	
2960500 V0012	Stainless steel heat exchanger 5.00 m ² for 2500 litre cylinders	
2960600 V0012	Stainless steel heat exchanger 6.00 m ² for 3000 litre cylinders	
2950800 V0012	Stainless steel heat exchanger 8.00 m ² for 4000 litre cylinders	
2961000 V0012	Stainless steel heat exchanger 10.00 m ² for 5000 litre cylinders	

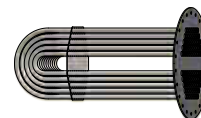

BF1 SERIES GLASSLINED CASING CYLINDER - COATED

CODE	MODEL	NOTES
F340H67 00052	BF-1 1500	
F340H70 00052	BF-1 2000	
F340H74 00052	BF-1 3000	
F340H80 00052	BF-1 5000	

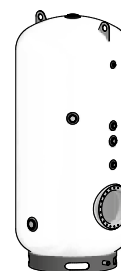

BF2 SERIES GLASSLINED CASING CYLINDER - COATED

CODE	MODEL	NOTES
F370H67 00052	BF-2 1500	
F370H70 00052	BF-2 2000	
F370H74 00052	BF-2 3000	
F370H80 00052	BF-2 5000	

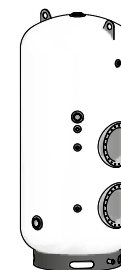

BF3 SERIES GLASSLINED CASING CYLINDER - COATED

CODE	MODEL	NOTES
F380H67 00052	BF-3 1500	
F380H70 00052	BF-3 2000	
F380H74 00052	BF-3 3000	
F380H80 00052	BF-3 5000	

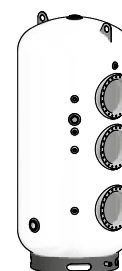

HEATING ELEMENTS WITHOUT THERMOSTAT - REINFORCED ELECTRICAL HEATERS

MODEL	CONNECTION	CODE	NOTES
MF 1KW/220V LENGTH 295	1" 1/4	8601000	
MF 1,65KW/220V LENGTH 450	1" 1/4	8601650	
MF 2KW/220V LENGTH 515	1" 1/4	8602000	
MF 2,6KW/220V LENGTH 675	1" 1/4	8602600	
MF 2,6KW/220V LENGTH 360	1" 1/4	8602601	
MF 3,3KW/220V LENGTH 825	1" 1/4	8603300	
MF 3,3KW/220V LENGTH 435	1" 1/4	8603301	
MF 4KW/220V LENGTH 510	1" 1/4	8604001	
TF 5KW/380V LENGTH 445	1" 1/2	8705000	
TF 6KW/380V LENGTH 510	1" 1/2	8706000	
TF 8KW/380V LENGTH 670	1" 1/2	8708000	
TF 10KW/380V LENGTH 820	1" 1/2	8710000	
TF 12KW/380V LENGTH 970	1" 1/2	8712000	

MF = Mono-phase; TF = Three-phase



HEATING ELEMENTS WITH THERMOSTAT - REINFORCED ELECTRICAL HEATERS

MODEL	CONNECTION	CODE	NOTES
RES.MONOP. + THERMOSTAT 1,5KW/230V LENGTH 320	1" 1/2	8T01500	
RES.MONOP. + THERMOSTAT 2,0KW/230V LENGTH 320	1" 1/2	8T02000	
RES.MONOP. + THERMOSTAT 2,2KW/230V LENGTH 320	1" 1/2	8T02200	
RES.MONOP. + THERMOSTAT 2,5KW/230V LENGTH 320	1" 1/2	8T02500	
RES.MONOP. + THERMOSTAT 3,0KW/230V LENGTH 320	1" 1/2	8T03000	
RES.THREEP. + THERMOSTAT 4,0KW/400V LENGTH 400	1" 1/2	8T04000	
RES.THREEP. + THERMOSTAT 5,0KW/400V LENGTH 500	1" 1/2	8T05000	
RES.THREEP. + THERMOSTAT 6,0KW/400V LENGTH 600	1" 1/2	8T06000	
RES.THREEP. + THERMOSTAT 9,0KW/400V LENGTH 700	1" 1/2	8T09000	
RES.THREEP. + THERMOSTAT 12,0KW/400V LENGTH 850	1" 1/2	8T12000	



MAGNESIUM ANODE

MODEL	(Ø x L)	CONNECTION	CODE	NOTES
MOD. 1	32 x 150	1"1/4	8560000 00002	
	32 x 200	1"1/4	8560010 00002	
	32 x 250	1"1/4	8560020 00002	
	32 x 320	1"1/4	8560040 00002	
	32 x 410	1"1/4	8560050 00002	
	32 x 520	1"1/4	8560060 00002	
	32 x 670	1"1/4	8560070 00002	
	32 x 700	1"1/4	8560080 00002	
MOD. 2	40 x 640	1"1/2	8560100 00002	
	32x350	1"1/2	8560045 00002	
MOD. 2	32x550	1"1/2	8560065 00002	
	32x350	1"1/4	8560046 00002	
	32x550	1"1/4	8560066 00002	
MOD. 2	32x700	1"1/4	8560086 00002	

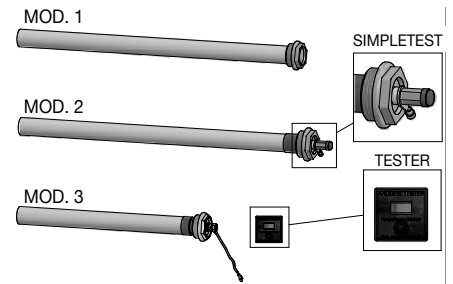

CATHODIC PROTECTIONS

Model	Code	NOTES
CATHODIC PROT. 550/150 L700/ 100 - 400 L	8560170	
CATHODIC PROT. 550/200 L750/ 500 - 1000 L	8560175	
CATHODIC PROT. 400/200 L600/ 1500 - 2500 L	8560180	
CATHODIC PROT. 450/250 L700/ 3000 - 5000 L	8560185	

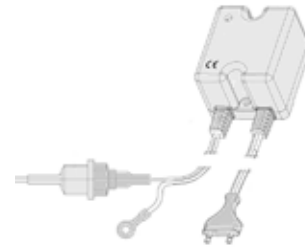

GASKETS

Model	Code	NOTES
Gasket SBR Ø 240X320X4 15F S.T.	4203300	
Gasket SBR Ø 240X320X4 15F C.T.	4213300	
Gasket SBR Ø 330X410X4 22F D11 S.T.	4204200 V0022	
Gasket SBR Ø 330X410X4 22F D11 C.T.	4214200 V0022	

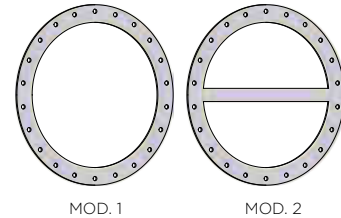

GASKETS FOR HIGH TEMPERATURES

Code	Model	NOTES
Gasket 240X320X4 15F S.T.	4203305	
Gasket 240X320X4 15F C.T.	4213305	
Gasket 330X410X4 22F Ø 11 S.T.	4204205 V0010	
Gasket 330X410X4 22F Ø 11 C.T.	4214205 V0010	

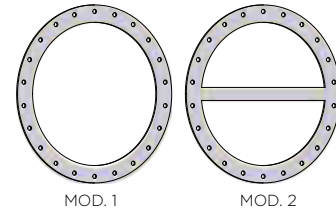

STAINLESS STEEL HEAT EXCHANGER HEADS

Code	Model	NOTES
Head Ø 330 15 HOLES Ø 14 1"1/4	3873304	
Head Ø 420 22 HOLES Ø 11 1"1/2	3874205 V0012	

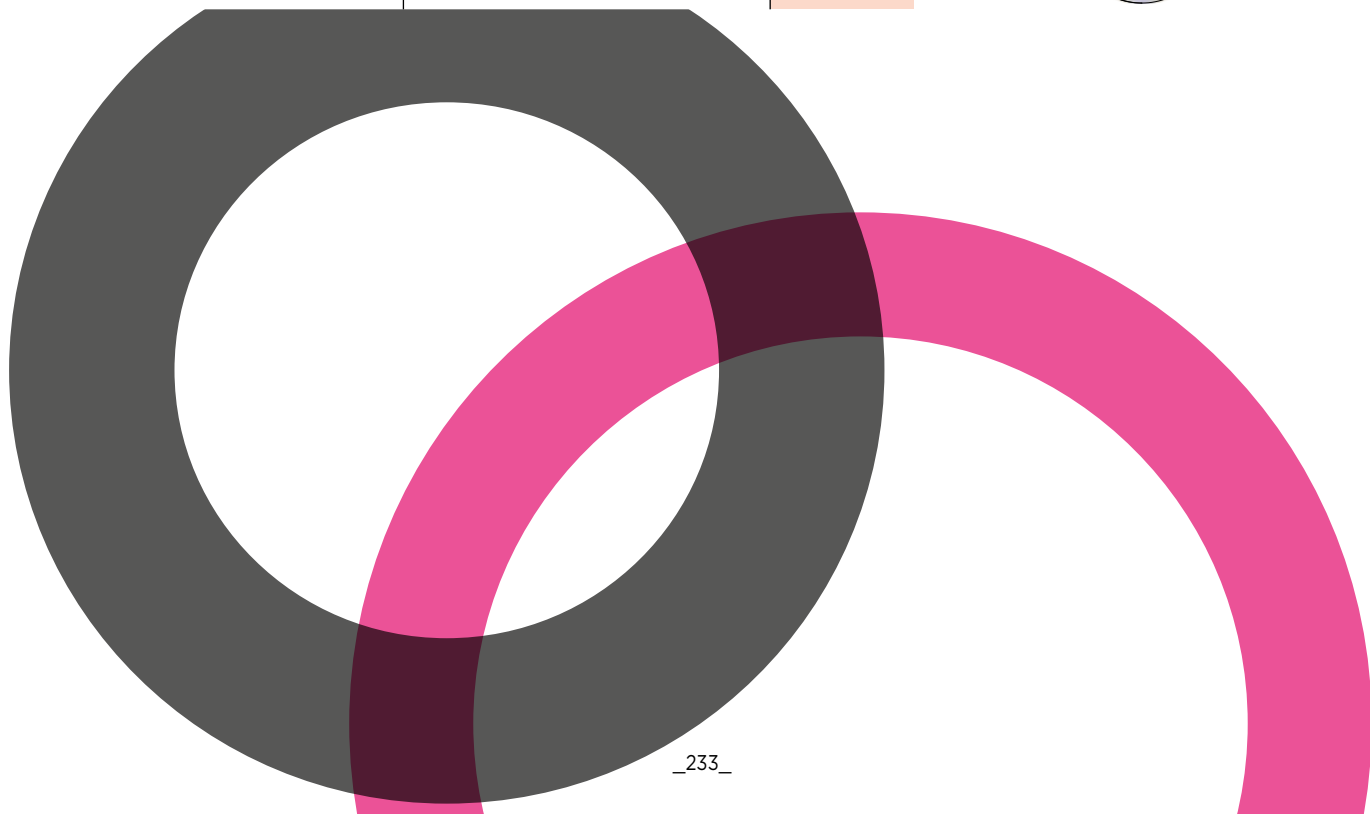
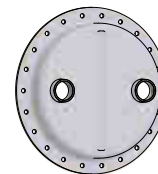

1. Preamble

These general conditions, unless otherwise agreed in writing, regulate all current and future sale agreements between the Parties.

2. Offers

- 2.1. The Buyer declares to grant and accept all measures concerning weight, surface, shape, size and, at any rate, all the technical specifications included by Elbi in its published documents.
- 2.2. Elbi reserves the right to make all changes without fore-notice it should arbitrarily deem necessary to enhance the product, as also to cease production of any model, excluding any right of the Buyer to demand compensation under any form.
- 2.3. The documentation enclosed to offers by Elbi is exclusively reserved to the Buyer, with the explicit prohibition to make it accessible, even partly, to third parties without due authorisation in writing by Elbi.

3. Orders

- 3.1 Every order submitted by the Customer is understood as accepted by Elbi only once it issues a Confirmation of Order. Submitted orders are legally binding for the Customer and cannot be changed or cancelled without consent in writing (including by fax or e-mail) by Elbi or with execution of the modified order.
- 3.2. If the Customer drafts an order in name and on behalf of third parties from whom it has received mandate to file orders, by signing the order it agrees to fully comply with the agreed terms.
- 3.3. Orders received by representatives of Elbi are not binding until they are accepted in writing (including by fax) by the latter, or rather, until their formal execution.
- 3.4. Elbi reserves the right to cancel an order if its execution is not feasible or is unreasonably costly due to an unpredictable impediment that is independent of its will.

4. Prices

- 4.1. Prices are ex-works, unless otherwise agreed in writing by the parties, and are expressed in euros. VAT is not included in the prices and will be invoiced separately based on the tax rate applicable on the date of invoice.

5. Delivery

- 5.1. Delivery terms are purely indicative. In no case will a delivery delay entitle the Customer to request compensation and/or entail cancellation of the order. Any right to compensation of damages is at any rate limited to the contract value.
- 5.2. If deliveries are delayed because of force majeure, the delivery date will be extended by the duration of the event that caused the delay.
- 5.3. If an established delivery date is deferred by the Customer, Elbi will be entitled to demand payment of the amount of the available goods, or rather, to further delay their delivery.

6. Shipment and transfer of risk

- 6.1. Procedure for shipment is decided by Elbi, unless otherwise agreed.
- 6.1. If packing is not included, it is invoiced at price of cost. Elbi does not accept returned packages.
- 6.3. For deliveries worth less than 1.000 euros (and for Sicily and Sardinia only, worth less than 1,500 euros), a surcharge of 5% will be applied, with a minimum contribution of 40,00 euros for transport expenses.
- 6.4. For deliveries to construction sites, a fixed contribution of 5% will be applied for transport expenses.

7. Returned goods

- 7.1. Goods can only be returned if Elbi grants authorisation in writing.
- 7.2. If the parties agree to return goods, Elbi will charge the Customer administrative fees of 30% of the invoiced amount. Elbi also reserves the right to charge further value reductions on returned goods.
- 7.3. Elbi will not accept goods returned 3 (three) months after their delivery.

8. Payment terms

- 8.1. Unless otherwise agreed in writing by the parties, payments must be made to Elbi in Limena (PD), Via Buccia 9.
- 8.2. All payments must be made by the due date indicated in the invoice.
- 8.3. The Customer cannot compensate its debt for supplied goods with any credits that Elbi has not acknowledged or has contested, and cannot suspend payments, in part or in full.
- 8.4. If the Customer makes a payment after the due date in invoice, Elbi will be entitled to issue a Bank Order and invoice for any arrears, which will be charged ex art. 5. of Legislative Decree no. 231/2002. The above without prejudice in any case to Elbi's right to take legal action in order to receive compensation of the greater damage. Issuance of a Bank Order entails the surcharge of stamp duty and any accessory bank fees. Interest will be due without the need to issue a formal notice of default.
- 8.5. Failure to comply with the payment terms applicable to a supply by the Customer will entitle Elbi to immediately demand payment of all pending amounts, with automatic expiry of the agreed term.

9. Suspension of a supply

- 9.1. Failure to pay an invoice or its delayed payment will entitle Elbi to suspend any pending deliveries until it receives payment of its credit.

10. Warranty

- 10.1. Elbi will deliver to the Customer goods compliant with the legislation applicable in Italy. The Customer agrees to accept goods that are compliant with the laws in the Country to which they are delivered and will promptly inform Elbi (at any rate prior to shipment) of any changes it wants made to the goods and/or packing.

11. Retained ownership

- 11.1. Upon delivery, the Customer must immediately inspect the goods.
- 11.2. Any claims must be submitted in writing to Elbi within 8 days from receipt of the goods or, in the event of concealed flaws, within 8 days from their discovery and by no later than one year from their delivery. Replacement of the goods does not mean that Elbi accepts the claim. Claims regarding quantity (no. of items) and packing conditions must be reported on the transport document upon delivery, or (if otherwise, the claim will be void) within 2 (two) business days following delivery of the goods.
- 11.3. Elbi agrees to solve any manufacturing flaw, poor quality standard or non-conformity of the products that are attributable to its production, and that occurred within the terms established by law from the date the Products were delivered, provided it is promptly informed thereof, in accordance with point 2 of this clause.
- 11.4. Except for negligence or severe misconduct, Elbi will be required (whichever it chooses) to either:
 - a) supply products to the Customer of the same kind and quality as those found to display flaws, or that are not compliant with agreed terms; Elbi can in such case demand, at the expense of the Customer, to have the faulty products returned, over which it will have ownership;
 - b) repair the flawed product at its expense or modify the product that is not compliant with the terms agreed in order;
 - c) refund the Customer the price paid for the non-compliant products upon their return.

The warranty herein encompasses and replaces any other warranties on flawed or non-compliant products and excludes any other liability on Elbi's part for supplied products; more specifically, the Customer cannot submit any other claim for damages, request a discount or termination of the contract. Once the warranty term is over, the Customer will not be entitled to submit any claim against Elbi.

- 11.5. Any repair and service performed under warranty will be subordinate to the Buyer processing payment for the goods.
- 11.6. The warranty is at any rate confined and limited to the exact correspondence of the supplied product to the one ordered in writing. It is the Customer's exclusive responsibility to solve any problems tied to assembly, adaptation to the intended use of the product and natural wear. The warranty moreover excludes any product part or accessory directly manufactured by the Customer or third parties.

12. Express termination clause

- 12.1. Goods delivered to the Customer remain property of Elbi until their invoiced price is paid in full.
- 12.2. For as long as Elbi retains ownership over the goods, the Buyer cannot without prior consent in writing by Elbi pawn or sell the supplied goods to third parties.

13. Safeguard clause

- 13.1 If any clause of these General Conditions of Sale proves ineffective or void, in part or in full, the other clauses of the Conditions will continue to be enforceable and applicable. The contractual parties agree to replace the void or ineffective clause with another one that will ensure that the economic scope originally intended for these Conditions can be legally pursued.

14. Applicable law and Competent Court

- 14.1. All agreements regulated by these General Conditions of Sale are, for all matters not pertaining to Italian law, regulated by the Vienna Convention of 1980. Any dispute that may arise between the parties will be settled by the sole competent Court of Padua, all other concurring or alternative Courts excluded.

15. Correspondence

- 15.1. Any correspondence and/or order submitted to Elbi must be submitted to the following address (or will otherwise be void): via Buccia 9, Limena (PD) – IT; Tel +39/049/8840677 Fax +39/049/8841610 e-mail: info@elbi.it

Pursuant to and by effect of art. 1341 of the Civil Code, the Buyer declares to have carefully read the above clauses under points 2) Offers; 3) Orders; 4) Prices; 5) Delivery; 6) Shipment and transfer of risk; 7) Returned goods; 8) Payment terms; 9) Suspension of a supply; 10) Warranty; 11) Retained ownership; 12) Express termination clause; 13) Safeguard clause; 14) Applicable law - Competent Court; 15) Correspondence.

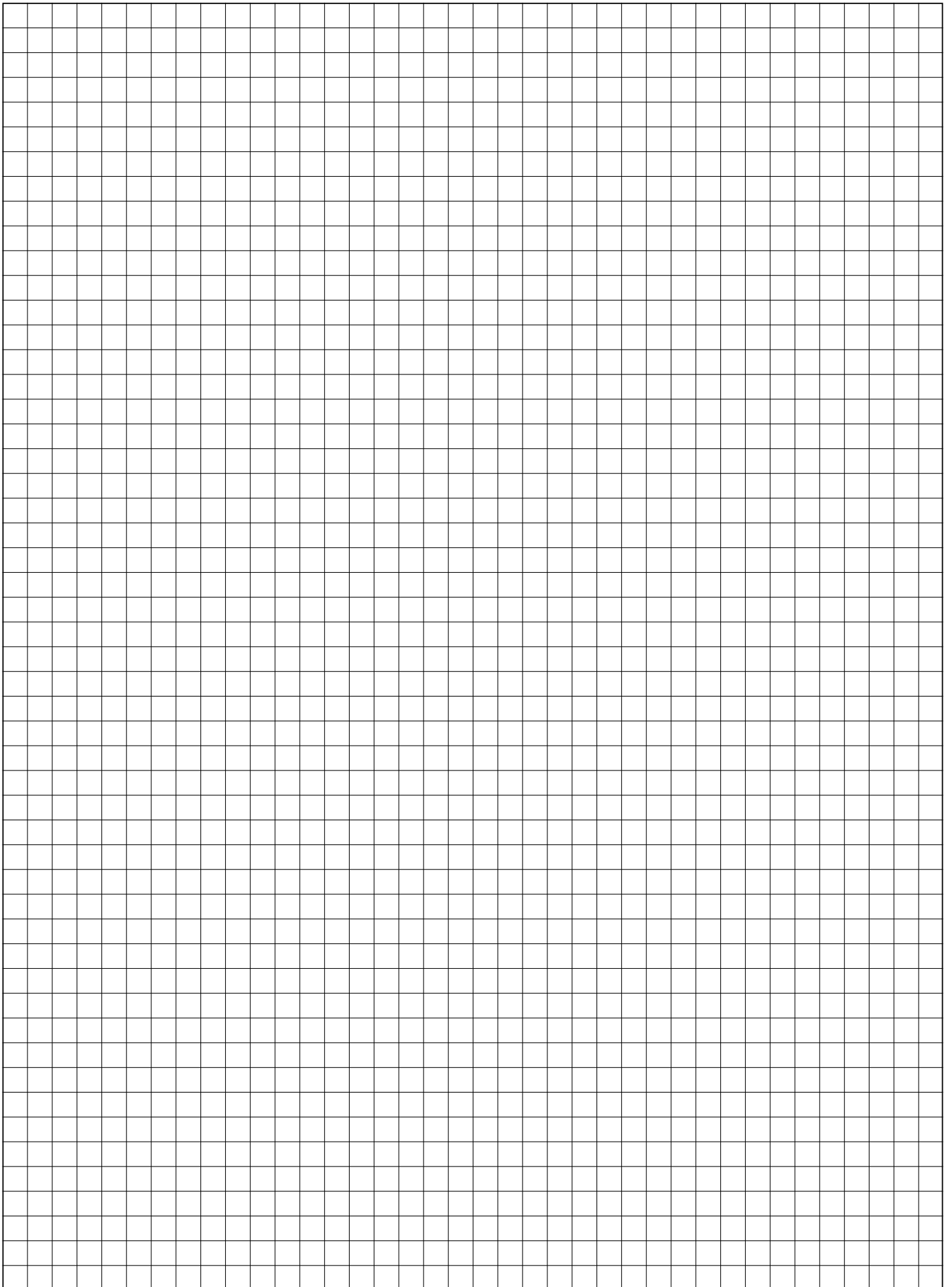

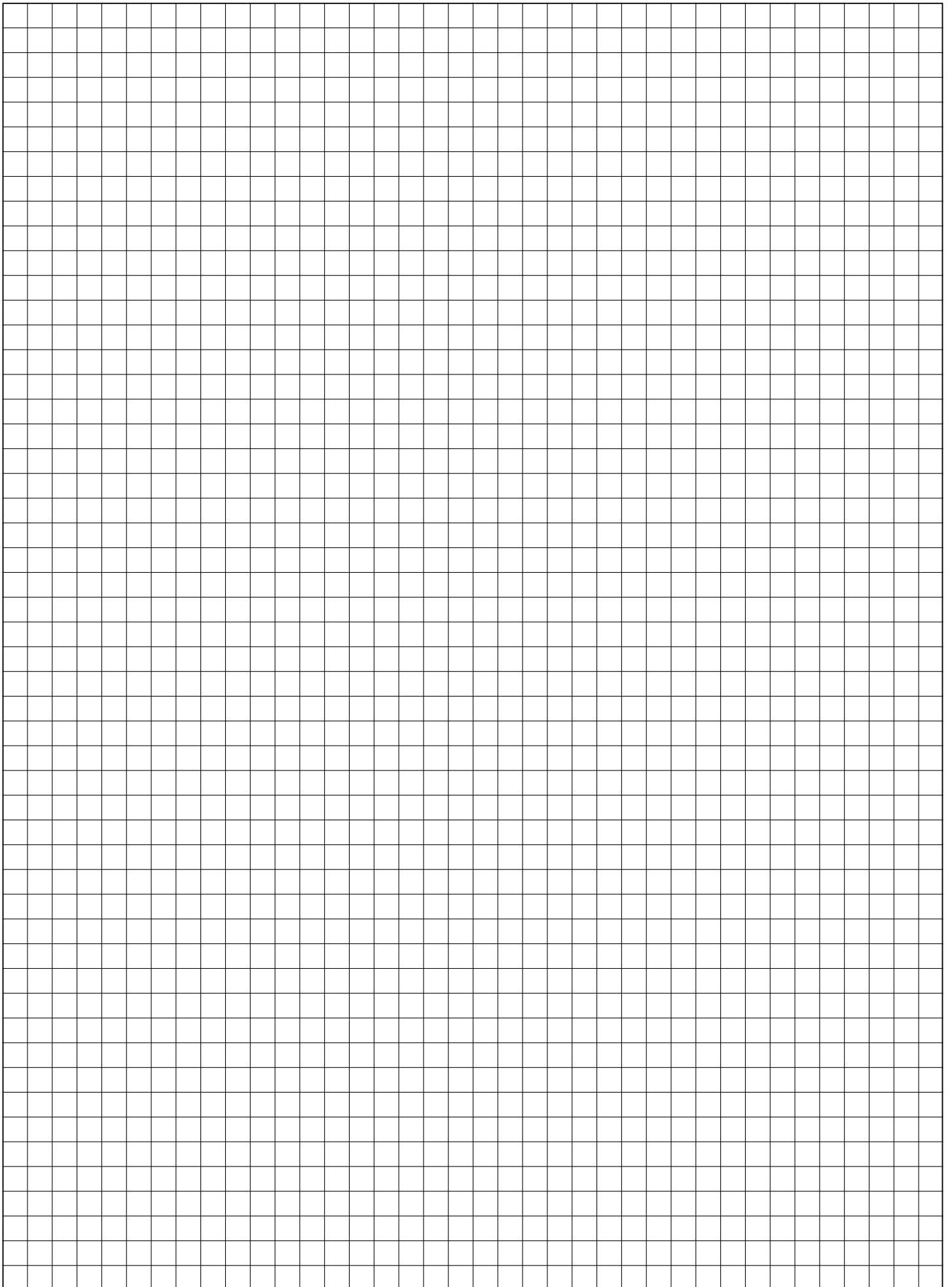

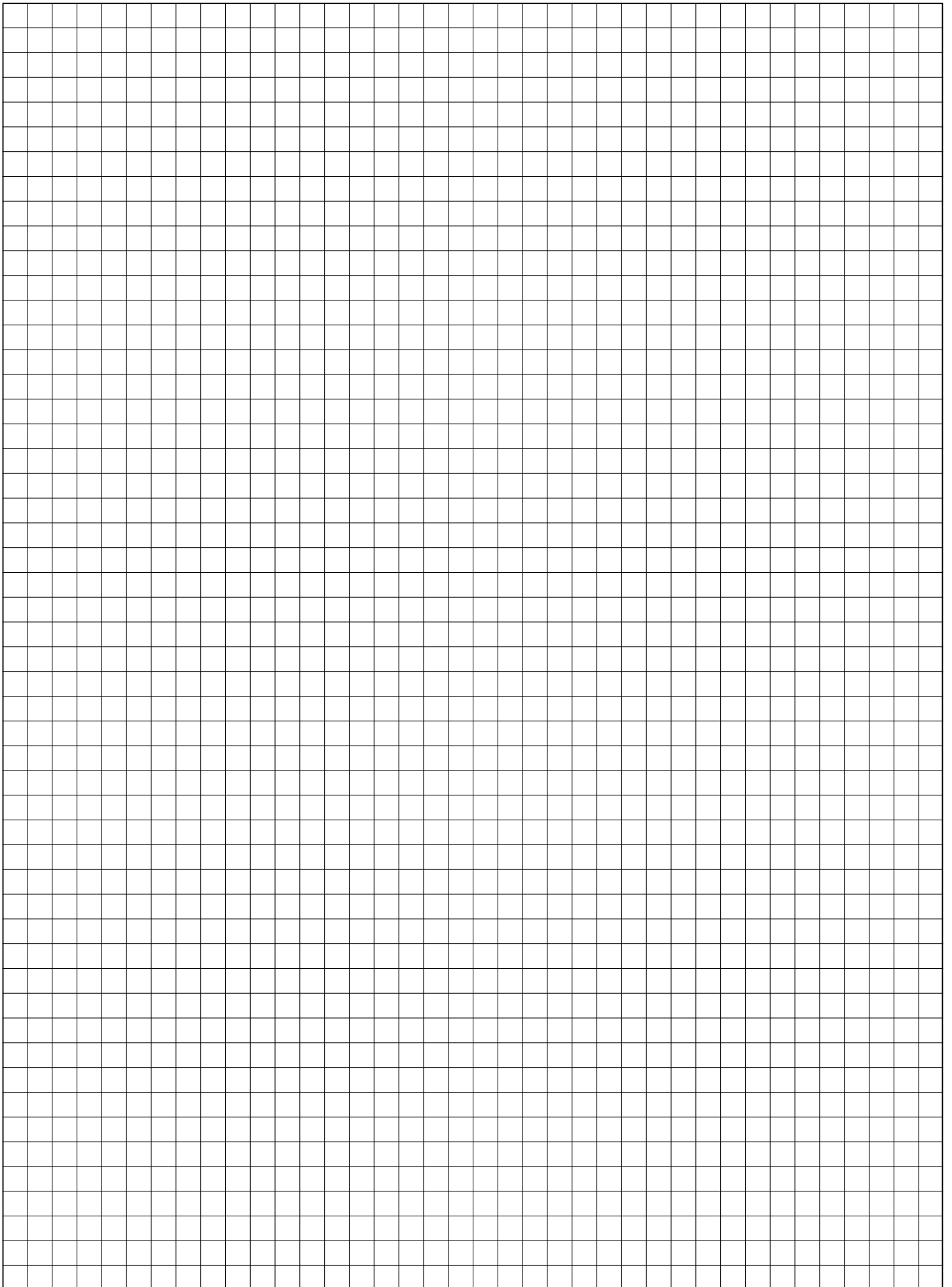

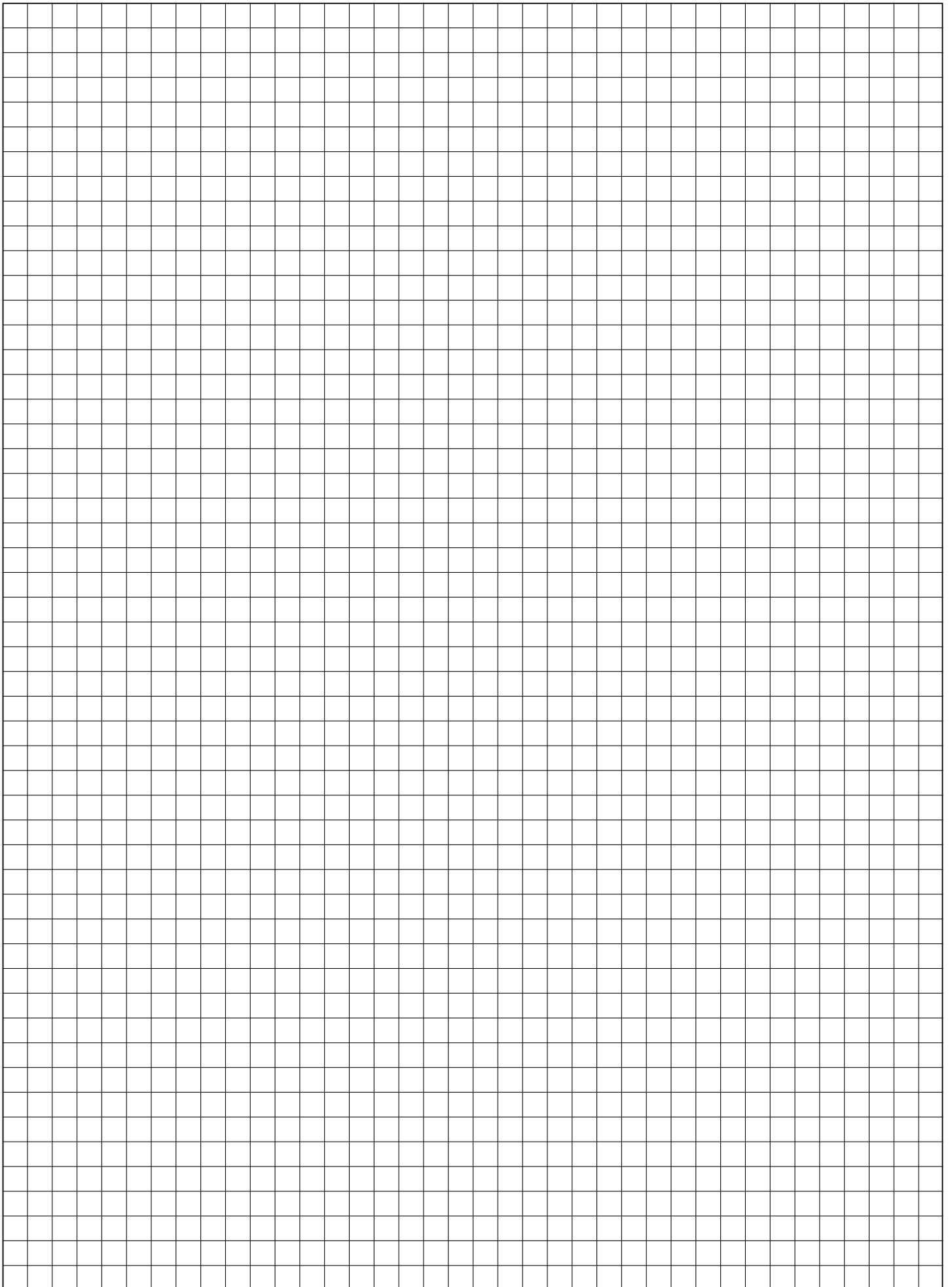

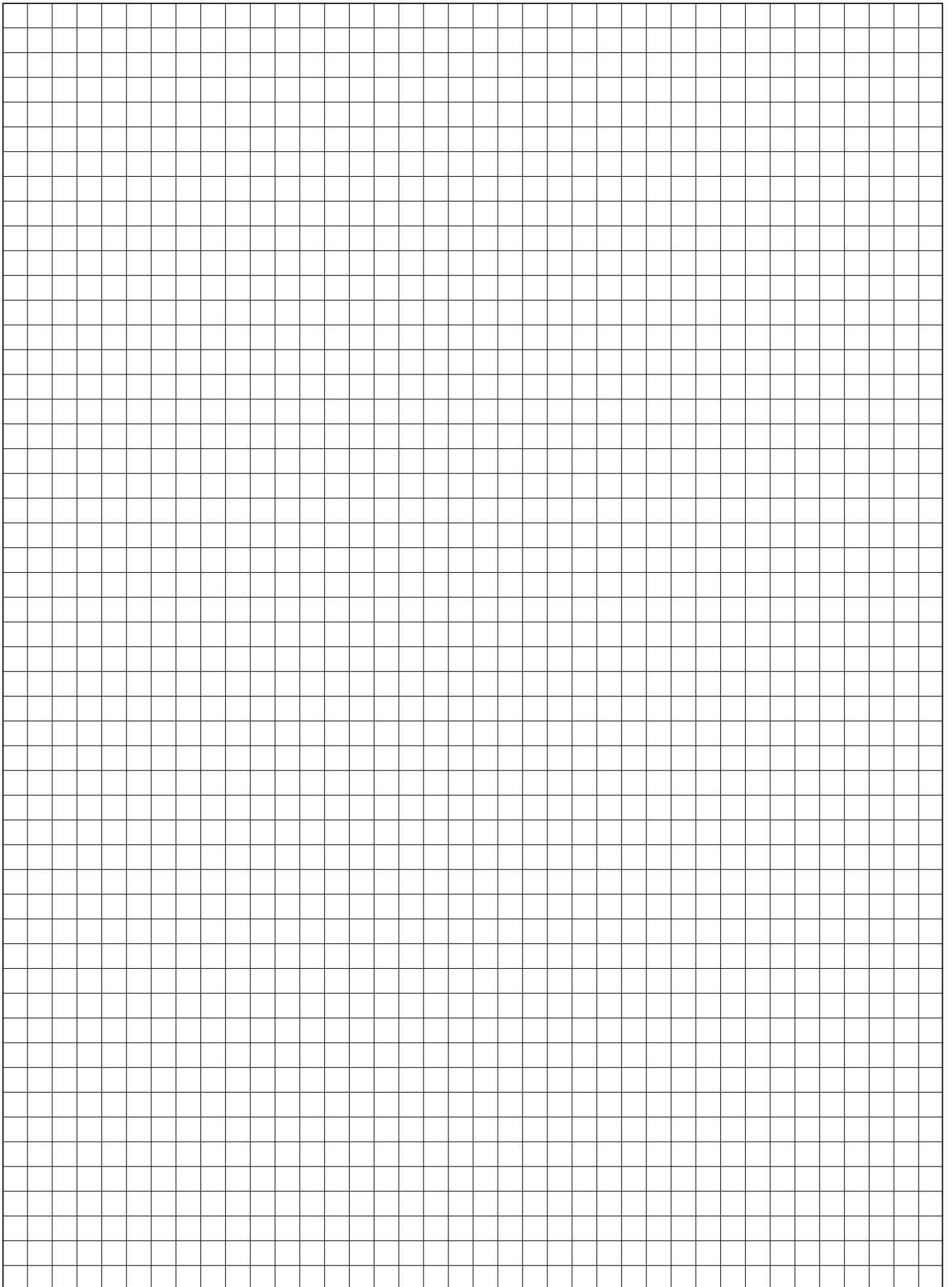



FERMO RESTANDO LE CARATTERISTICHE BASILARI DEL PRODOTTO, LA SOCIETÀ SI RISERVA DI APPORTARE MODIFICHE IN OGNI MOMENTO AL SOLO SCOPO DI MIGLIORAMENTO.

WHILE THE BASIC FEATURES OF THE PRODUCT WILL REMAIN UNCHANGED, THE COMPANY RESERVES THE RIGHT TO MAKE ANY CHANGE TO ITS PRODUCTS WITHOUT NEED FOR PRIOR NOTICE.













I COLORI E LE MISURE RIPRODOTTI NEI CATALOGHI SONO INDICATIVI.
THE COLOURS AND DIMENSIONS SHOWN IN THE CATALOGUE ARE AN INDICATION ONLY.

E' VIETATA LA RIPRODUZIONE ANCHE PARZIALE DI QUESTO CATALOGO.
IT IS FORBIDDEN TO REPRODUCE ANY PART OF THIS CATALOGUE.

PRINT March 2017

**COMPANY WITH
QUALITY SYSTEM
CERTIFIED BY DNV GL
= ISO 9001 =**

LEGEND OF HYDRAULIC SYMBOLS

	SAFETY VALVE	RI	RETURN FROM SYSTEM	
	DRAIN	MP	DELIVERY TO FLOOR SYSTEM	ONLY COMBI QUICK PUFFER PLUS
	SHUT-OFF VALVE	RP	RETURN TO FLOOR SYSTEM	ONLY COMBI QUICK PUFFER PLUS
	PRESSURE REDUCER	Vs	SANITARY CYLINDER VOLUME	ONLY COMBI
	CHECK VALVE	Vr	THERMO-ACCUMULATOR VOLUME	ONLY COMBI
	MIXER	AV	DELIVERY TO ALTERNATIVE SOURCE	ONLY COMBI QUICK
	VENT VALVE	AR	RETURN TO ALTERNATIVE SOURCE	ONLY COMBI QUICK
	SOLAR COLLECTOR TEMPERATURE PROBE	Ss	SANITARY HEAT EXCHANGER	ONLY COMBI QUICK
	TEMPERATURE PROBE	Sa	HEAT EXCHANGER FOR ALTERNATIVE SOURCE	ONLY COMBI QUICK
	ADJUSTMENT ELECTRONIC CONTROL UNIT	Ssol	SOLAR HEAT EXCHANGER	
	CIRCULATOR	1	ELBI CYLINDER/ACCUMULATOR	
	THERMOMETER	2	D/DV SERIES SANITARY EXPANSION TANK	
	GAUGE	3	ER/ERCE SERIES EXPANSION TANK	
ACS/DHV	SANITARY HOT WATER	4	TRADITIONAL BOILER	
KW	SANITARY COLD WATER	5	SOLAR COLLECTOR	
RC	SANITARY WATER RECIRCULATION	6	DS/DSV SERIES SOLAR EXPANSION TANK	
HV	DELIVERY FROM BOILER	7	STP SERIES TEMPERATURE REDUCING TANK	
HR	RETURN TO BOILER	8	PELLET BOILER / STOVE	ONLY COMBI QUICK
SV	DELIVERY FROM SOLAR COLLECTOR	9	SOLAR MODULE	ONLY SOLAR
SR	RETURN TO SOLAR COLLECTOR	10	PLATE HEAT EXCHANGER	ONLY SAC
MI	DELIVERY TO SYSTEM	11	BIOMASS BOILER	



cod. 8109250 V3000 - 03/2017

Elbi S.p.A.

Headquartes and
main plant:
C.P. 103 - Via Buccia, 9
35010 LIMENA (PD)
ITALY
Tel +39-049-8840677
Fax +39-049-8841610

**Plant and warehouse
in Modugno:**

Via delle Magnolie, 19
70026 MODUGNO (BA)
ITALY
Tel +39-080-5316843
Fax +39-080-5316822

Elbi of America, Inc

Houston, TX 77032
Tel. 001 (713) 674-2900
Fax 001 (713) 674-2982
www.elbi.net

Brea, CA 92821
Tel. 001 (714) 674-0590

**e-mail: info@elbi.it
www.elbi.it**